

 **IZELTAS®**



MAYIS / **2022**

FİYAT KATALOĞU



İZELTAŞ UYGULAMASI, APP STORE VE GOOGLE PLAY'DE!

Katalogdan bayilere, video içeriklerinden şikayet ve geri bildirimlerine kadar birçok alana ulaşılabilirliği kolaylaştıran app uygulamamız yayında.



IOS ve Android uyumlu ücretsiz uygulamamızı hemen indirin,
İzeltaş cebiniz kadar yakınınızda olsun!



GARANTİ ŞARTLARI / WARRANTY CONDITIONS

A-KAPSAM İÇİ

1. Normal kullanım şartlarına uygun kullanılan ancak, imalat veya malzeme hatası tespit edilen ürünler, ömür boyu garanti kapsamında, tamir edilir veya mümkün değilse, derhal yenisi ile değiştirilir.

B-KAPSAM DIŞI

Aşağıda yazılı şartlarda kullanılan aletler, garanti kapsamı dışında olup, yenisi ile değiştirilmezler.

1. Kullanım amacı veya kullanma talimatı dışında kullanılmış olan ürünler.
2. Aşırı zorlama ile, boru takılarak veya çekiçle vurularak darbeli kullanım sonucu deforme olmuş ya da kırılmış olan ürünler.
3. Kullanıcı tarafından üzerinde taşlama, zımparalama, delme veya kaynak yapılarak orijinal hali bozulmuş olan ürünler.
4. Kullanıldıktan sonra, gerekli koruyucu bakımları yapılmadan, tozlu, rutubetli ve çamurlu ortamlarda bekletilerek fonksiyonu kaybolmuş ürünler.
5. Uygun olmayan rutubetli ortamlarda, uzun süre stoklanarak, paslanmış, korozyona uğramış olanlar.
6. Uzun süre kullanılmış veya kullanım ömrünü tamamlamış, buna bağlı olarak eskimiş, yıpranmış, deforme olmuş ürünler.



EMNİYETLİ VE DOĞRU EL ALETİ KULLANIM KURALLARI

A-UYULMASI GEREKEN KURALLAR:

1. Anahtarın ölçüsünün kullandığınız parçaya göre uygun olduğundan emin olunuz.
2. Kullanım esnasında aletin doğru şekilde yerleştirildiğinden emin olunuz.
3. Aleti sık kontrol ediniz. Aşınmış, zarar görmüş aletleri değiştiriniz.
4. Aleti kullanım şartlarına uygun olarak kullanınız, aşırı yük uygulamayınız.
5. Özellikle çekiçlerde vurma yüzeyinin, vurulan yüzeyden daha büyük olmak zorunda olduğuna dikkat ediniz.
6. Havalı aletlerde daima uygun aksesuarı kullanınız. (Ayrıca basınçlı havanın yağlandığından emin olunuz.)
7. Çalışma şartlarına göre uygun kişisel koruma teçhizatı kullanınız.
8. Tekerlekli takım dolaplarını, daima kapılarını ve hareketli bölümlerini kilitledikten sonra hareket ettiriniz.
9. Tekerlekli takım dolabı üzerinde çalışırken, tekerleklerini frenleyiniz.
10. Yüksek gerilimli çalışma ortamlarında TS EN IEC 60900 Standartına uygun olarak üretilmiş VDE belgeli ürünleri kullanınız.
11. Aletlerin nemli ve ıslak ortamlarda kullanımını ardından mutlaka kurutunuz ve hafif yağlayınız.

B-YAPILMAMASI GEREKEN İŞLEMLER:

1. Boru vb. uzatmalar kullanılarak olması gereken tork gücünü aşmayınız. (Özellikle tüm anahtarlarda)
2. Hiçbir aleti üretim maksadına aykırı işlerde kullanmayınız. (örneğin: tornavidanın levye veya keski gibi kullanımı)
3. Aşırı güç uygulayarak (boru takarak veya çekiçle vurarak) aleti zorlamayınız. (örneğin: anahtarlar ve tornavidalar)
4. Hiçbir zaman, kullandığımız aleti kendinden daha sert olan bir cisme vurmeyiniz. (örneğin: çekiç ve keski)
5. Aletleri değişikliğe uğratmayınız. (Şekli veya bir kısmını)
6. Metrik ölçülü anahtarları, inch ölçülü civatalarda kullanmayız veya tersini yapmayınız.
7. Yıpranmış ve hatalı aletleri kullanmayınız.
8. Tekerlekli tamir dolabı dolu iken, birden fazla çekmeceyi açık tutmayınız, çekmeceler açıkken hareket ettirmeyiniz.
9. Aletin fonksiyonunu iyileştirmek maksadı ile üzerinde zımpara, taş, kaynak vb. işlem yapmayınız.
10. Aletin kullanımını sırasında boya veya kaplamanın çıkacağı etkilere maruz bırakmayınız. Aksi halde korozyon dayanımı negatif etkilenecektir.
11. İzolasyonu zedelenmiş, sapı yıpranmış VDE sertifikalı ürünleri hiçbir şekilde yüksek gerilim ihtiva eden ortamlarda kullanmayınız.
12. Kontrol kaleminin iç mekanizmasını kesinlikle sökmeye çalışmayınız. Kontrol kalemleri 110 – 250 VAC çalışma aralığı için uygundur.
13. Yukarıda bahsedilen şartlara ve doğru kullanıma riayet ederek, her zaman amaca yönelik uygun aletleri kullanınız.

A- INCLUDED CASES

1. *Products used in accord with normal use conditions but found to have production or material errors will be repaired or if this is not possible replaced immediately under lifetime warranty.*

B- EXCLUDED CASES

Products used under any of the conditions listed below are excluded from the warranty scope and cannot be replaced with new ones:

1. *Products used outside the intended purpose or instructions of use;*
2. *Products deformed or broken due to excessive forcing, pipe attachment or hammer impact;*
3. *Products whose original form is altered by the user by stoning, grinding, perforation or welding;*
4. *Products which lost their function due to being left in dusty, moist or muddy environments without necessary protective maintenance after use;*
5. *Products which became rusted or corroded due to being stored in unsuitable, moist environments for extended periods of time;*
6. *Products which are used for a long period of time or which have completed their useful life and accordingly have become old, worn out and deformed.*

RULES FOR SAFE AND CORRECT USE OF HAND TOOL

A- PRACTICAL RULES:

1. *Make sure size of the wrench is appropriate for the work piece.*
2. *Make sure the tool is positioned correctly during use.*
3. *Frequently control the tool. Replace worn or damaged tools.*
4. *Use the tool in accord with instructions of use. Do not place too much load on the tool.*
5. *Especially beware of the point that the impact surface of a hammer must be larger than the impacted surface.*
6. *Always use appropriate accessories for pneumatic tools. (Also make sure the pneumatic system is properly lubricated.)*
7. *Use personal protection equipment appropriate for work conditions.*
8. *Always make sure to lock lids and moving parts of wheeled set cabinets before moving them.*
9. *Make sure to lock brakes of the wheeled set cabinets before working on them.*
10. *Use VDE certified products made in accord with TS EN IEC 60900 Standard in high voltage work environments.*
11. *Make sure to dry and lightly lubricate tools after use in moist and wet environments.*

B- ACTIONS TO AVOID:

1. *In case of use with extensions like pipes, etc. do not exceed the specified torque value (especially in case of all wrenches).*
2. *Do not use any tool outside of its intended purpose (e.g. do not use a screwdriver as a lever or a chisel).*
3. *To not force the tool (e.g. wrenches and screwdrivers) by using excessive force (by pipe attachment or hammer impact).*
4. *Never use the tool to hit another object harder than the tool (e.g. hammer and chisels).*
5. *Do not alter the tools (in form or partially).*
6. *Do not use metric sized wrenches on inch sized bolts or vice-versa.*
7. *Do not use worn out or faulty tools.*
8. *Do not leave multiple drawers open when using the wheeled set cabinet and do not move the cabinet while the drawers are open.*
9. *Do not perform grinding, stoning, welding, etc. on the tool in order to improve its function.*
10. *Do not expose the tool to conditions that might result in loss of paint or coating during use. Otherwise corrosion resistance of the tool will be affected.*
11. *Never use VDE certified products with damaged or worn isolation or handle in high voltage work environments.*
12. *Never attempt to dismantle the internal assembly of the tester. Testers are suitable for use in the 110 – 250 VAC operation range.*
13. *Always use the right tool for the right job and follow the conditions and rules of correct usage detailed above.*

Yarım asırlık 'güven'

Kalite yolculuğu inanmakla başlar.

Türkiye'nin ilk ve en büyük el aletleri üreticisi İZELTAŞ, 1968 yılında Ege'nin gözbebeği İzmir'den işte bu inançla yola çıktı. Yüzde 100 Türk sermayesiyle oluşturulan ve günden güne büyüyen İZELTAŞ, modern teknolojiyle donatılmış dev tesislerinde üretilen dört bin beş yüz den fazla ürünle 40 ülkeye ihracat yaparak hem kendi insanına hem de ülke ekonomisine katkı sağlıyor.

El aletlerinin yanı sıra üretilen dövme parçalar ile başta otomotiv olmak üzere inşaat, denizcilik ve madencilik sektörüne, savunma ve havacılık sanayilerine, ziraat endüstrisine, altyapı işlerine dek birçok kamu ve özel sektör kuruluşuna hizmet sunuyor.

Daha iyisi, daha yenisi için...

Kalıphane, dövme, işleme, ısıl işlem, krom-nikel kaplama, boyama, plastik daldırma, plastik enjeksiyon ve markalama departmanlarından oluşan dünyadaki ender entegre fabrikalardan İZELTAŞ'ta üretimin her aşamasında kalite kontrolüne tabi tutulan ürünler; fiziksel, metalürjik, kimyasal ve elektriksel testlerden geçirilerek İZELTAŞ güvencesine alınıyor. Ar-Ge ve inovasyon ışığında değişime ve gelişime her daim açık olan İZELTAŞ, bu sayede gücüne güç katıyor.

T.C. Sanayi ve Teknoloji Bakanlığında AR-GE Merkezi belgesine sahip İZELTAŞ, TS EN ISO 9001 Kalite Yönetim Sistemi, ISO/IEC 27001 Bilgi Güvenliği Yönetim Sistemi, TS (OHSAS) 18001 İş Sağlığı ve Güvenliği Yönetim Sistemi, TS EN ISO 14001 Çevre Yönetim Sistemi, TS EN ISO 50001 Enerji Yönetim Sistemleri; TSE, TSEK, VDE GS ürün kalite belgeleri ve yüksek teknolojisi ile sadece Türkiye'de değil, dünyada da farkını ortaya koyuyor.

Önce güvenlik, sonra üretim

İnsan önemli, emek değerlidir. İZELTAŞ, "Önce güvenlik" anlayışından ayrılmadan, çalışanları için önlem almaya, onları iş sağlığı ve güvenliği konusunda eğitmeye devam ediyor. Çünkü; "İnsan vücudunun yedek parçası yoktur"

Size ulaştıktan sonra...

Satış sonrasında tüketici haklarını koruma ve sınırsız hizmet anlayışı İZELTAŞ'ın vazgeçilmez şirket politikalarından birini oluşturuyor.

Dolayısıyla...

- El aletleri' dendiğinde akla gelen ilk isim olabildiysek,
- Yarım asırdır 'aileden biri' olmanın hakkını verebildiysek,
- 'Türk malı' sözünün altına imzamızı atabildiysek,
- 'Yıllarca kullanılır' diyerek her zaman tercih edildiysek,

Gücümüzü, şevkimizi ve inancımızı siz değerli bayilerimiz ve tüketicilerimizden alıyoruz.

850 çalışanımızla birlikte üreterek, değer sağlayarak dünya markası olmanın haklı gururunu yaşıyoruz.

Nice başarılı yıllara!

Half a century of reliability

Faith is the essential step on the journey to achieve utmost quality.

As the first and largest hand tool manufacturer of Turkey, İZELTAŞ, had this faith as it started its journey in 1968 in Izmir, the beautiful city in the Aegean region. Its establishment, consisting of 100% national capital, İZELTAŞ has grown in years into an industrial giant with huge facilities equipped with state-of-the-art technologies and over 4500 products. Exporting to more than 40 countries, the company is a prominent contributor to not only the Turkish economy but also the community.

Along with manufacturing hand tools, İZELTAŞ produces forged steel parts for various industries like automotive, construction, maritime, mining, aviation, defence, agriculture and infrastructure.

Newer and better

İZELTAŞ is one of the few fully integrated factories in the world that consists of die tooling, forging, processing, heat processing, chrome-nickel plating, dyeing, pvc coating, plastic injection and marking departments. Every stage of the production is tested for quality assurance using physical, metallurgical, chemical and electrical methods. R&D and innovation are the key words that empower İZELTAŞ as a company which embraces development and improvement as its main philosophy.

İZELTAŞ is an accredited R&D Center by the Ministry of Science, Industry and Technology and has been certified with the following: ISO 9001 Quality Management System, ISO/IEC 27001 Informationsecurity Management System, OHSAS 18001 Occupational Health and Safety Management System, ISO 14001 Environment Management System, ISO 50001 Energy Management System certification, TSE, TSEK and VDE GS product certification.

Safety before production

Humans are the most significant factors of any industry and their labour is precious. Health and safety awareness is the fundamental policy of İZELTAŞ. The company continuously organizes training programs on occupational health and safety which emphasise that safety comes first and it is not possible to fix humans by changing the damaged organs with spare ones.

Customer satisfaction

Another fundamental policy of İZELTAŞ is the customer satisfaction. The company is dedicated to serve its customers and protect their rights as consumers.

Hence...

- We are the first brand that comes to mind in the hand tools industry
- We are valued almost as a part of the families of our consumer
- We have proved ourselves worthy of the statement "Made in Turkey"
- We have been the first choice of the consumers for durability over the years

Our power, enthusiasm and faith are derived from our distinguished dealers and consumers.

We are proud to have become a world brand with our 850 employees who strive everyday to contribute to the productivity of the company, creating an added value for the economy and our community.

To many successful years to come!

Takım Dolapları ve Takım Çantaları
Tool Trolleys, Tool Boxes



5-41

Anahtarlar
Wrenches



43-63

Lokma ve Bijon Anahtarları
Sockets and Rim Wrenches



65 -94

Boru Anahtarları ve Penseler
Pipe Wrenches and Pliers



95-113

1000V Grubu Ürünler
1000V Product Group



115-123

Tornavida ve Allen Anahtarlar
Screwdrivers and Hex Key Wrenches



125-148

Keskiler ve Çekiçler
Chisels and Hammers



149-156

Genel El Aletleri
General Hand Tools



157-168

Makaslar
Shears



169-176

Çektirmeler
Pullers



177-183



185-196

Yedek Parçalar
Spare Parts



197-201

Ticari Teşhir Standları
Commercial Display Stands



203-206

Teknik Bilgiler ve İndeks
Technical Information and Index



207-236



*"Sadece el aleti üretmiyoruz;
el aletleriyle her şeyi üretiyoruz."*

*"We don't just produce hand tools;
we build everything with hand tools."*

İZELTAS®

TAKIM DOLAPLARI
TOOL TROLLEYS,
TOOL BOXES

TAKIM DOLAPLARI
VE TAKIM
ÇANTALARI

TAKIM DOLAPLARI TAKIM ÇANTALARI VE ALET SETLERİ

TOOL TROLLEYS, TOOL BOXES AND
HAND TOOL SETS



Takim Dolapları
Tool Cabinets

Takim Çantaları
Tool Boxes

Servis Masaları
Service Tables

Alet Setleri
Tool Sets



İZELTAS YOUTUBE



İZELTAS YOUTUBE

(*) İşaretili olan ürünler stoklarla sınırlıdır.
Limited with stocks.

8245 PREMIUM SERİSİ / PREMIUM SERIES

Premium Serisi Takım Dolabı (5-7 Çekmeceli)
Premium Series Workshop Trolley (5-7 Drawers)



✓ 6 bölmeli sağlam ve dayanıklı ABS plastik üst malzeme tabla.
● Resistant and solid top cover having 6 divisions



✓ %100 açılabilir teleskopik raylar.
● %100 extendable telescopic slides



✓ Merkezi kilit
✓ Mandal sistemi
✓ Devrilme emniyet sistemi
● Central lock
● Handgrip Lock system
● Anti tilt system



✓ 2 sabit, 2 hareketli frenli tekerlek ø 125mm
● 2 swivel castors with brake
2 fixed castors ø 125mm



✓ Standard tutma sapı
● Standard handle



✓ Plastik köşe koruma
● Plastic corner protection



✓ Yüksek dayanımlı elektrostatik toz boya.
● High strength electrostatic powder coating.



✓ Havluluk x1
Avadanlık x2 Askılık x1
● Paper Roll Holder
x1 Bottle & Tins Holder x2 Hanger x1

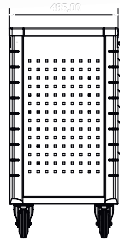
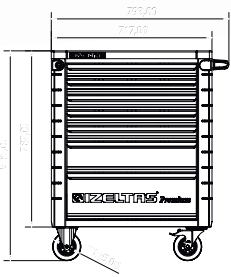
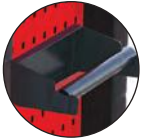

Ölçü/Size: 485x717x944 mm

Sacdan imal edilmiş, Fırın boya
Made of sheet metal, Electrostatic paint



İZELTAS YOUTUBE

| KOD/CODE | ÇEKMECE DRAWERS | 35 kg | 35 kg | 35 kg | Kg | RENK COLORS | FİYAT TL/Ad |
|---|-----------------|-------|-------|-------|----|----------------------|-------------|
| 8245 32 1005 | 5 | 2X | 1X | 2X | 64 | | 7261,75 |
| 8245 32 1007 | 7 | 5X | 1X | 1X | 70 | RAL 9005 RAL 3020 | 9400,90 |
| 8245 00 7096 Dolu/Full 243 Parça/Pcs | 7 | 5X | 1X | 1X | | | 26005,25 |

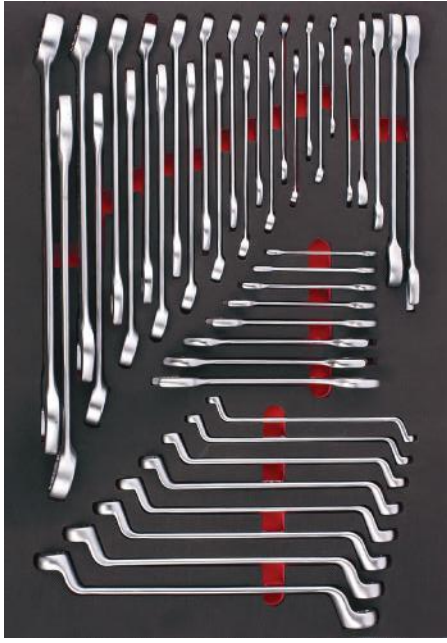

1. Premium Seri Çekmece/Drawer Kod / Code 8245001042

| KOD CODE | İÇERİK CONTENTS | ☐ | FIYAT TL/Ad |
|----------|---|----|-------------|
| 0100 | İki Ağız Anahtar Kısa Boy D/E Open jaw wrenches Short Pattern 6x7-8x9-10x11-12x13-14x15-16x17-18x19-20x22 | 8 | |
| 0320 | Kombine Anahtar Kısa Boy Combination wrenches Short Pattern 6-7-8-9-10-11-12-13-14-15-16-17-18-19-20-21-22-24-27-30-32 | 21 | |
| 0430 | Yıldız Anahtar Ring Wrenches 6x7-8x9-10x11-12x13-14x15-16x17-18x19-20x22 | 8 | |
| 0340 | Cırcır Kombine Anahtar / Combination Wrench With Ratchet 8-10-13-17-19 | 5 | |

2. Premium Seri Çekmece/Drawer Kod / Code 8245002094

| KOD CODE | İÇERİK CONTENTS | ☐ | FIYAT TL/Ad |
|----------|--|----|-------------|
| 1107 | 1/4" Lokmalı Allen Uçlar / Hexagonal Bits Socket 2,5 - 3 - 4 - 5 - 6 - 7 - 8 - 10 | 8 | |
| 1107 | 1/4" Lokmalı Torx Uç / Torx Bits Socket T8-T9-T10-T15-T20-T25-T27-T30-T40 | 9 | |
| 1107 | 1/4" Lokmalı Yıldız Uç / Phillips Bits Socket PH1-PH2-PH3 | 3 | |
| 1107 | 1/4" Lokmalı Düz Uç / Slotted Bits Socket 3 - 4 - 5,5 - 6,5 | 4 | |
| 1107 | 1/4" Altı Köşe Derin Lokma / Deep Socket Wrench 6 Point 4-5-5,5-6-7-8-9-10-11-12-13 | 11 | |
| 1113 | 1/2" Lokmalı Allen Uç / Hexagonal Bits Socket 5-6-7-8-10-12-14 | 7 | |
| 1113 | 1/2" Lokmalı Torx Uç / Torx Bits Socket T20-T25-T27-T30-T40-T45-T50-T55-T60 | 9 | |
| 1107 | 1/4" Altı Köşe Lokma Takımı / Socket Wrench Set 4 - 5 - 6 7 - 8 - 9 - 10 11 - 12 - 13 Altı Köşe Six Points 1/4" Cırcır kolu / Ratchet Handle 1/4" Mafsalsal / Universal Joint 1/4" T Kol / Sliding T Handle | 15 | |
| 1113 | 1/4" Ara Kol / Extention Bar 50-100 mm 1/2" Buji Lokma Lastikli Spark Plug Socket With Rubber 16 mm | 1 | |
| 1113 | 1/2" Lokma Takımı / Socket Wrench Set 10 - 11 - 12 - 13 14 - 15 - 16 - 17 18 - 19 - 21 - 22 23 - 24 - 26 - 27 28 - 30 - 32 Altı Köşe Six Points 1/2" Cırcır Kolu 32 Diş / Ratchet Handle 1/2" Mafsalsal / Universal Joint 1/2" T Kol Adaptör / Sliding T Handle Adapter 1/2" Ara Kol / Extension Bar 125 - 250 mm | 24 | |

3. Premium Seri Çekmece/Drawer Kod / Code 8245003014

| KOD CODE | İÇERİK CONTENTS | ☐ | FIYAT TL/Ad |
|----------|---|---|-------------|
| 3700 | Yan Keski Opak Seri / Side Cutting Pliers 160 mm | 1 | |
| 3020 | Kombine Pense Opak Seri / Combination Pliers 180 mm | 1 | |
| 3220 | Kargaburun Düz Uçlu Opak Seri / Nose Pliers Flat 180 mm | 1 | |
| 4300 | Opak Seri Düz Uçlu Tornavida / Screwdriver, Flat 3x80-5x125-7x150 | 3 | |
| 4320 | Opak Seri Yıldız Uçlu Tornavida / Screwdriver, Phillips 3x60-4.5x80-6x100-8x150 | 4 | |
| 3301 | Dış Segman Pensi Düz / Circlip Pliers, External Flat 140-180mm | 2 | |
| 3321 | İç Segman Pensi Düz / Circlip Pliers, Internal Flat 140-180mm | 2 | |

4. Premium Seri Çekmece/Drawer Kod / Code 8245004043

| KOD CODE | İÇERİK CONTENTS | □ | FİYAT TL/Ad |
|----------|---|----|-------------|
| 4770 | Lokma Uçlu Tornavida / Nutspinner 6-7-8-9-10-13 | 6 | |
| 4910 | Torx Allen Takım / Torx Key Wrench Set T9-T10-T15-T20-T25-T27-T30-T40 | 8 | |
| 4900 | Allen Takımı 6 Köşe / Hex Key Wrench Set 2-2.5-3-3.5-4-5-6-7-8-9-10-12 | 12 | |
| 4906 | Yuvarlak Başlı Uzun Allen Takımı / Hex key Wrench Ballpoint Long Pattern Set 1.5-2-2.5-3-4-5-6-8-10 | 9 | |
| 4920 | T Tipi Allen Anahtar / T Type Hex Key Wrench 2.5-3-4-5-6-7-8-10 | 8 | |

5. Premium Seri Çekmece/Drawer Kod / Code 8245005043

| KOD CODE | İÇERİK CONTENTS | □ | TL/Ad. |
|----------|---|----|--------|
| 4565 | Oto Elektrik Kontrol Kalemi Car Voltage Tester 135mm | 1 | |
| 07415 | Sıralı Tel Fırça 4 Sıralı / Hand Brush 4 Rows | 1 | |
| 2400 | Üniversal Fort Pense / Waterpump Pliers Universal 240 mm | 1 | |
| 2500 | Üniversal Ayarlı Pense Universal Grip 250 mm | 1 | |
| 0600 | Kurbağacık Anahtar / Adjustable Wrench 10" | 1 | |
| 4780 | Manyetik Bits Tutucu Tornavida / Screwdriver, Magnetic Bit Holder 6.3x120 | 1 | |
| 4800 | 31'li Bits Set (Plastik Kutulu) / Bits Set in plastic case | 31 | |
| 4110 | Düz Topaç Tornavida / Screwdriver, Stubby, Flat 6.5x25 | 1 | |
| 4130 | Yıldız Topaç Tornavida / Screwdriver, Stubby, Phillips 6x25 | 1 | |
| 5500 | Düz Keski Krom Flat Cold Chisel 150 mm | 1 | |
| 5800 | Tesviyeci Çekici Machinist's Hammer 300-1500 gr | 2 | |
| 6350 | Levye Oluklu / Tyre Lever 500 mm | 1 | |

6. Premium Seri Çekmece/Drawer Kod / Code 8245006009

| KOD CODE | İÇERİK CONTENTS | □ | FİYAT TL/Ad |
|----------|---|---|-------------|
| 1855 | Mafsallı T Kol Lokma T- Handle Wrench with Universal Join 8-10-12-13-17-19 | 6 | |
| 6230 | Gres Pompası Grease Gun 500cc | 1 | |
| 06375 | Ayarlı Yağ Filtre Sökeceği Adjustable Slot Type Oil Filter Wrench | 1 | |
| 6225 | Madeni Yağdanlık (Flexible Uçlu) Oiler With Flexible Spout 200cc | 1 | |



İZELTAS USTA İŞİ
SOHBETLER



İZELTAS YOUTUBE

(*) İşaretili olan ürünler stoklarla sınırlıdır.
Limited with stocks.

8241 PRO SERİSİ / PRO SERIES

Pro Serisi Takım Dolabı (5-6-7-8 Çekmeceli)
Pro Series Workshop Trolley (5-6-7-8 Drawers)



✓ Merkezi kilit sistemi, mandal sistemi ve devrilme emniyet sistemi.
● Central lock system, handgrip lock system and antitilt system.



✓ Teleskobik rulmanlı kızaklar tüm çekmeceler %100 açılabilir.
● Telescopic slides which are %100 extendable.



✓ 8 bölümlü sağlam ve dayanıklı ABS plastik üst malzeme tabla.
● Durable ABS worktop with 8 divisions



✓ 2 sabit, 2 hareketli frenli tekerlek Ø 125mm
● 2 swivel castors with brake, 2 fixed castors Ø 125mm



✓ Yüksek dayanımlı elektrostatik toz boya.
● High strength electrostatic powder coating



✓ Toplam 6 Adet yan ve arka avadanlık bölümleri.
● 6 tool holders



Ölçü/Size: 470x670x1007 mm

Sacdan imal edilmiş, Fırın boya
Made of sheet metal, Electrostatic paint

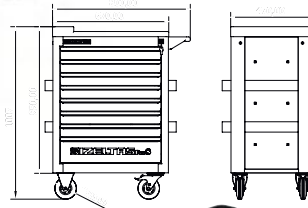

| KOD/CODE | ÇEKMECE DRAWERS | 35 kg | 35 kg | 35 kg | Kg | RENK COLORS | FİYAT TL/Ad |
|--------------------------------------|-----------------|-------|-------|-------|----|-------------|-------------|
| 8241 32 1005 | 5 | 1X | 4X | -- | 59 | | |
| 8241 32 1006 | 6 | 4X | 1X | 1X | 62 | | |
| 8241 32 1007 | 7 | 5X | 2X | -- | 65 | | |
| 8241 32 1008 | 8 | 7X | 1X | -- | 67 | | |
| 8241 32 2005 | 5 | 1X | 4X | -- | 59 | | |
| 8241 32 2006 | 6 | 4X | 1X | 1X | 62 | | |
| 8241 32 2007 | 7 | 5X | 2X | -- | 65 | | |
| 8241 32 2008 | 8 | 7X | 1X | -- | 67 | | |
| 8241 32 3005 | 5 | 1X | 4X | -- | 59 | | |
| 8241 32 3006 | 6 | 4X | 1X | 1X | 62 | | |
| 8241 32 3007 | 7 | 5X | 2X | -- | 65 | | |
| 8241 32 3008 | 8 | 7X | 1X | -- | 67 | | |
| 8241 00 1209 Dolu/Full 206 Parça/Pcs | 8 | 7X | 1X | -- | | | |

(★) İşaretili olan ürünler stoklarla sınırlıdır.
Limited with stocks.

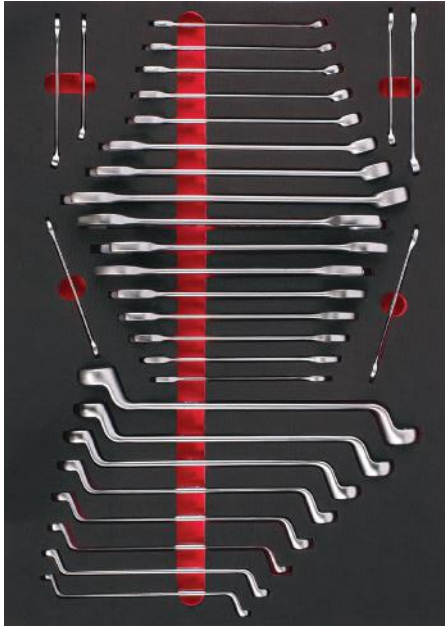

1. Pro Seri Çekmece/Drawer

Kod / Code 8241001030

| KOD CODE | İÇERİK CONTENTS | □ | FİYAT TL/Ad |
|----------|--|----|-------------|
| 0130 | İki Ağız Anahtar Uzun Boy / D/E Open Jaw Wrench Long Pattern 6x7 - 8x9 - 10x11 - 12x13 14x15 - 16x17 - 18x19 - 20x22 21x23 - 24x26 | 10 | |
| 0330 | Kombine Anahtar Uzun Boy / Combination Wrench Long Pattern 6 - 7 - 8 - 9 - 10 - 11 - 12 - 13 14 - 17 - 19 - 22 | 12 | |
| 0430 | Yıldız Anahtar / D/E Ring Wrench 6x7 - 8x9 - 10x11 - 12x13 14x15 - 16x17 18x19 - 20x22 | 8 | |



2. Pro Seri Çekmece/Drawer

Kod / Code 8241002072

| KOD CODE | İÇERİK CONTENTS | □ | FİYAT TL/Ad |
|----------|---|----|-------------|
| 1107 | 1/4" Altı Köşe Lokma Takımı / 1/4" Socket Wrench Set 4 - 5 - 6 7 - 8 - 9 - 10 11 - 12 - 13 Altı Köşe Six Point | 15 | |
| | 1/4" Cırcır kolu / 1/4" Ratchet Handle | | |
| | 1/4" Mafsal / 1/4" Universal Joint | | |
| | 1/4" T Kol / 1/4" Sliding T Handle | | |
| | 1/4" Ara Kol / 1/4" Extension Bar 50-100 mm | | |
| 1113 | 1/2" Lokma Takımı / 1/2" Socket Wrench Set 10 - 11 - 12 13 - 14 - 15 16 - 17 - 18 19 - 21 - 22 23 - 24 - 26 27 - 28 - 30 32 | 24 | |
| | 1/2" Cırcır Kolu 32 Diş / 1/2" Ratchet Handle | | |
| | 1/2" Mafsal / 1/2" Universal Joint | | |
| | 1/2" T Kol Adaptör/ 1/2" Sliding T Handle Adapter | | |
| | 1/2" Ara Kol / 1/2" Extension Bar 125-250 mm | | |
| 1113 | 1/2" Lokmalı Allen Uçlar / 1/2" Hexagonal Bits Sockets H5-H6-H7-H8-H10-H12-H14 | 7 | |
| 1113 | 1/2" Lokmalı Star Uç / 1/2" Star Bits Socket T20-T25-T27-T30-T40-T45-T50-T55-T60 | 9 | |
| 0330 | Kombine Anahtar Uzun Boy / Combination Wrench Long 16-18 | 2 | |
| 4900 | Allen Takımı 6 Köşe / Hex Key Wrench Set 2-2.5-3-3.5-4-5-6-7-8-9-10-12 | 12 | |



3. Pro Seri Çekmece/Drawer

Kod / Code 8241003051

| KOD CODE | İÇERİK CONTENTS | □ | FİYAT TL/Ad |
|----------|---|----|-------------|
| 07415 | Sıralı Tel Fırça 3 Sıralı / Hand Brush 3 Rows | 1 | |
| 6350 | Levye Oluklu / Tyre Lever 400 mm | 1 | |
| 6220 | Spiralli Mıknatıs / Flexible Magnet Holder 500 gr | 1 | |
| 4110 | Düz Topaç Tornavida / Screwdriver , Stubby, Flat 6.5x25 | 1 | |
| 4130 | Yıldız Topaç Tornavida / Screwdriver , Stubby, Phillips 6x25 | 1 | |
| 4770 | Lokma Uçlu Tornavida / Nutspinner 6-7-8-9-10-13 | 6 | |
| 4780 | Manyetik Bits Tutucu Tornavida / Screwdriver, Magnetic Bit Holder 6.3x120 | 1 | |
| 4905 | Yuvarlak Başlı Allen Takımı / Hexkey Wrench Ballpoint Set 2-2,5-3-4-5-6-8-10 | 8 | |
| 4800 | Bits Set Takım (Plastik Kutulu) / Bits Set in Plastic Case | 31 | |



4. Pro Seri Çekmece/Drawer

Kod / Code 8241004027

| KOD CODE | İÇERİK CONTENTS | □ | FİYAT TL/Ad |
|----------|--|----|-------------|
| 0340 | Cırcır Kombine Anahtar / Combination Wrench With Ratchet 10-13-17-19 | 4 | |
| 4909 | T Tipi Torx Allen Anahtar / Torx Allen Key T type T9-T10-T15-T20-T25-T27-T30-T40 | 8 | |
| 1108 | 1/2" Altı Köşe Derin Lokma / 1/2" Deep Socket Wrench, six points 10-11-12-13-14-15-16-17-18-19 | 10 | |
| 1113 | 1/2" Altı Köşe Havalı Lokma / 1/2" Impact Socket Wrench 13-17-18-19-24 | 5 | |



5. Pro Seri Çekmece/Drawer

Kod / Code 8241005010

| KOD CODE | İÇERİK CONTENTS | □ | FİYAT TL/Ad |
|----------|--|---|-------------|
| 3331 | İç Eğri Segman Pense / Circlip Pliers, Internal, Bent 170 mm | 1 | |
| 3321 | İç Düz Segman Pense / Circlip Pliers, Internal, Flat 180 mm | 1 | |
| 3311 | Dış Eğri Segman Pense / Circlip Pliers, External, Bent 170 mm | 1 | |
| 3301 | Dış Düz Segman Pense / Circlip Pliers, External, Flat 180 mm | 1 | |
| 3700 | Yan Keski Opak İzole / Side Cutting Pliers, 160 mm | 1 | |
| 3220 | Düz Kargaburun Opak İzole / Nose Pliers, 200 mm | 1 | |
| 3020 | Kombine Pense Opak İzole / Combination Pliers, 180 mm | 1 | |
| 2510 | Spesiyal Ayarlı Pense / Special Grip 250 mm | 1 | |
| 0600 | Kurbağacık Anahtar / Adjustable Jaw Wrench 10" | 1 | |
| 2400 | Üniversal Fort Pense / Waterpump Pliers Universal 240 mm | 1 | |



6. Pro Seri Çekmece/Drawer

Kod / Code 8241006018

| KOD CODE | İÇERİK CONTENTS | □ | FİYAT TL/Ad |
|----------|---|---|-------------|
| 4300 | Opak Seri Düz Uçlu Tornavida / Opak Screwdriver, Flat 4x100-5x125-6x150-8x175 | 4 | |
| 4320 | Opak Seri Yıldız Uçlu Tornavida / Opak Screwdriver, Phillips 4.5x80-6x100 | 2 | |
| 5800 | Tesviyeci Çekiç / Mechanist Hammer 300 gr | 1 | |
| 5850 | Plastik Çekiç / Plastic Hammer ø30 | 1 | |
| 5545 | Konik Pim Zimba / Drift Punch 5 mm | 1 | |
| 5550 | Düz Pim Zimba / Split Pin Punch 5 mm | 1 | |
| 5540 | Nokta Zimba / Center Punch 5x120 | 1 | |
| 5500 | Düz Keski / Flat Cold Chisel 150 mm | 1 | |
| 4920 | T Tipi Allen Anahtar / T Type Hex Key Wrench 3-4-5-6-7-8 | 6 | |



İZELTAS YOUTUBE

(*) İşaretili olan ürünler stoklarla sınırlıdır.
Limited with stocks.

8242 GARAJ SERİSİ / GARAGE SERIES

Garaj Serisi Takım Dolabı (5-6-7-8 Çekmeceli)
Garage Series Workshop Trolley (5-6-7-8 Drawers)



- ✓ Ergonomik sap
- Ergonomic handle



- ✓ 8 Bölmeli, sağlam ABS tabla
- Durable ABS worktop with divisions



- ✓ Havluluk x1
- Avadanlık x2
- Askılık x1
- Paper Roll Holder x1
- Bottle & Tins Holder x2
- Hanger x1



- ✓ %100 açılabilir teleskobik raylar
- %100 extendable telescopic slides



- ✓ Merkezi kilit sistemi, mandal sistemi devrilme emniyet sistemi.
- Central locking, system handgrip lock system antitilt system



- ✓ 2 sabit, 2 hareketli frenli tekerlek Ø 125mm
- 2 swivel castors with brake 2 fixed castors Ø 125 mm



- ✓ Yüksek dayanımlı elektrostatik toz boya.
- High strength electrostatic powder coating

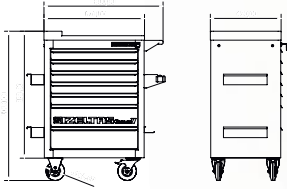

Ölçü/Size: 470x670x1010 mm

Sacdan imal edilmiş, Fırın boya
Made of sheet metal, Electrostatic paint



RAL 7016
RAL 3020

RAL 7016
RAL 5003

RAL 7016
RAL 7035

| KOD/CODE | ÇEKMECE DRAWERS | 35 kg | 35 kg | 35 kg | Kg | RENK COLORS | FİYAT TL/Ad |
|-------------------------|-----------------|------------|-------------|-------------|----|----------------------|-------------|
| | | 400x548x68 | 400x548x143 | 400x548x218 | | | |
| 8242 32 1005 | 5 | 1X | 4X | -- | 59 | | |
| 8242 32 1006 | 6 | 4X | 1X | 1X | 62 | RAL 7016 RAL 3020 | |
| 8242 32 1007 | 7 | 5X | 2X | -- | 65 | | |
| 8242 32 1008 | 8 | 7X | 1X | -- | 67 | | |
| 8242 32 2005 | 5 | 1X | 4X | -- | 59 | | |
| 8242 32 2006 | 6 | 4X | 1X | 1X | 62 | RAL 7016 RAL 5003 | |
| 8242 32 2007 | 7 | 5X | 2X | -- | 65 | | |
| 8242 32 2008 | 8 | 7X | 1X | -- | 67 | | |
| 8242 32 3005 | 5 | 1X | 4X | -- | 59 | | |
| 8242 32 3006 | 6 | 4X | 1X | 1X | 62 | RAL 7016 RAL 7035 | |
| 8242 32 3007 | 7 | 5X | 2X | -- | 65 | | |
| 8242 32 3008 | 8 | 7X | 1X | -- | 67 | | |
| 8242 00 1142 | 7 | 5X | 2X | -- | | | |
| Dolu/Full 139 Parça/Pcs | | | | | | | |
| 8242 00 8142 | 8 | 7X | 1X | -- | | | |
| Dolu/Full 139 Parça/Pcs | | | | | | | |

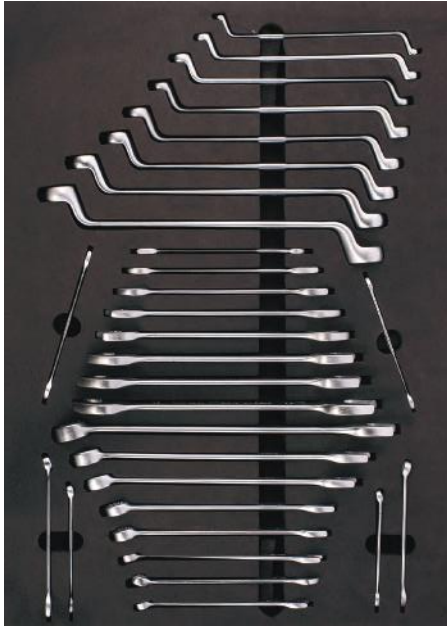

1. Garaj Seri Çekmece/Drawer

Kod / Code 8242001030

| KOD CODE | İÇERİK CONTENTS | □ | FİYAT TL/Ad |
|----------|--|----|-------------|
| 0130 | İki Ağız Anahtar Uzun Boy D/E Open Jaw Wrench Long Pattern 6x7 - 8x9 - 10x11 - 12x13 14x15 - 16x17 - 18x19 - 20x22 - 21x23 - 24x26 | 10 | |
| 0330 | Kombine Anahtar Uzun Boy Combination Wrenches Long Pattern 6 - 7 - 8 - 9 - 10 - 11 - 12 - 13 - 14 - 17 - 19 - 22 | 12 | |
| 0430 | Yıldız Anahtar Ring Wrench 6x7 - 8x9 - 10x11 - 12x13 - 14x15 - 16x17 18x19 - 20x22 | 8 | |

2. Garaj Seri Çekmece/Drawer

Kod / Code 8242002072



| KOD CODE | İÇERİK CONTENTS | □ | FİYAT TL/Ad |
|----------|--|----|-------------|
| 1113 | 1/2" Lokmalı Allen Uçlar Hexagonal Bits Socket H5-H6-H7-H8-H10-H12-H14 | 7 | |
| 1113 | 1/2" Lokmalı Star Uç / 1/2 Star Bits Socket T20-T25-T27-T30-T40-T45-T50-T55-T60 | 9 | |
| 0330 | Kombine Anahtar Uzun Boy Combination Pliers Long 16-18 | 2 | |
| 4900 | Allen Takımı Altı Köşe / Hex Key Wrench Set 2-2.5-3-3.5-4-5-6-7-8-9-10-12 | 12 | |
| 1107 | 1/4" Altı Köşe Lokma Takımı Socket Wrench Set 4 - 5 - 6 7 - 8 - 9 - 10 11 - 12 - 13 Altı Köşe Six Points 1/4" Cırcır Kolu Ratchet Handle 1/4" Mafsal Universal Joint 1/4" T Kol / Sliding T Handle 1/4" Ara Kol / Extension Bar 50 -100 mm | 15 | |
| 1113 | 1/2" Lokma Takımı Socket Wrench Set 10 - 11 - 12 13 - 14 - 15 16 - 17 - 18 19 - 21 - 22 23 - 24 - 26 27 - 28 - 30 32 Altı Köşe Six Points 1/2" Cırcır Kolu 32 Diş Ratchet Handle 1/2" Mafsal Universal Joint 1/2" T Kol Adaptör Sliding T Handle Adapter 1/2" Ara Kol Extension Bar 125-250 mm | 24 | |

3. Garaj Seri Çekmece/Drawer Kod / Code 8242003010

| KOD CODE | İÇERİK CONTENTS | ☐ | FİYAT TL/Ad |
|----------|---|---|-------------|
| 3331 | İç Eğri Segman Pense Circlip Pliers Internal (Bent) 170 mm | 1 | |
| 3321 | İç Düz Segman Pense Circlip Pliers Internal (Flat) 180 mm | 1 | |
| 3311 | Dış Eğri Segman Pense Circlip Pliers External (Bent) 170 mm | 1 | |
| 3301 | Dış Düz Segman Pense Circlip Pliers External (Flat) 180 mm | 1 | |
| 3700 | Yan Keski Opak Seri Side Cutting Pliers 160 mm | 1 | |
| 3220 | Düz Kargaburun Opak Seri Nose Pliers (Flat) 200 mm | 1 | |
| 3020 | Kombine Pense Opak Seri Combination Pliers 180 mm | 1 | |
| 2510 | Spesiyal Ayarlı Pense / Special Grip 250 mm | 1 | |
| 0600 | Kurbağacık Anahtar / Adjustable Wrench 10" | 1 | |
| 2400 | Üniversal Fort Pense / Waterpump Pliers Üniversal 240 mm | 1 | |

4. Garaj Seri Çekmece/Drawer Kod / Code 8242004018

| KOD CODE | İÇERİK CONTENTS | ☐ | FİYAT TL/Ad |
|----------|---|---|-------------|
| 4300 | Opak Seri Düz Uçlu Tornavida Screwdriver, Opak Flat 4x100-5x125-6x150-8x175 | 4 | |
| 4320 | Opak Seri Yıldız Uçlu Tornavida Screwdriver, Opak Phillips 4.5x80-6x100 | 2 | |
| 5800 | Tesviyeci Çekiç Machinist's Hammer 300 gr | 1 | |
| 5850 | Plastik Çekiç Plastic Hammer ø30 | 1 | |
| 5545 | Konik Pim Zimba Drift Punch 5 mm | 1 | |
| 5550 | Düz Pim Zimba Split Pin Punch 5 mm | 1 | |
| 5540 | Nokta Zimba Center Punch 5x120 | 1 | |
| 5500 | Düz Keski Flat Cold Chisel 150 mm | 1 | |
| 4920 | T Tipi Allen Anahtar / Hex Key Wrench 3-4-5-6-7-8 | 6 | |

5. Garaj Seri Çekmece/Drawer Kod / Code 8242005011

| KOD CODE | İÇERİK CONTENTS | ☐ | FİYAT TL/Ad |
|----------|---|---|-------------|
| 07415 | Sıralı Tel Fırça 3 Sıralı Hand Brush 3 Raws | 1 | |
| 6350 | Levye Oluklu Tyre Lever, Straight 400 mm | 1 | |
| 6220 | Spiralli Mıknatıs Flexible Magnet Holder 500 gr | 1 | |
| 4110 | Düz Topaç Tornavida Screwdriver Stubby Flat 6.5x25 | 1 | |
| 4130 | Yıldız Topaç Tornavida Screwdriver Stubby Phillips 6x25 | 1 | |
| 4770 | Lokma Uçlu Tornavida Nut Spinner 6-7-8-9-10-13 | 6 | |



IZELTAS YOUTUBE

(*) İşaretili olan ürünler stoklarla sınırlıdır.
Limited with stocks.

8235 PARTNER SERİSİ / PARTNER SERIES

Partner Mobil Takım Dolabı (5 Çekmeceli)
 Partner Workshop Trolley (5 Drawers)



✓ Merkezi kilit sistemi ve mandal sistemi.
 ● Central lock system and handgrip lock system.



✓ Teleskobik rulmanlı kızaklar tüm çekmeceler %100 açılabilir.
 ● Telescopic slides which are %100 extendable.



✓ 8 Bölmeli, sağlam ABS tabla
 ● 8 Durable ABS worktop with divisions



✓ 2 sabit, 2 hareketli frenli tekerlek ø 100mm
 ● 2 swivel castors with brake
 2 fixed castors ø 100 mm

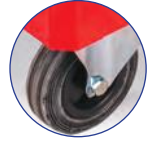

✓ Yüksek dayanımlı elektrostatik toz boya.
 ● High strength electrostatic powder coating

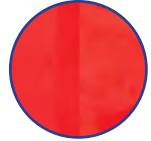

Ölçü/Size: 470x670x975 mm

Sacdan imal edilmiş, Fırın boya
 Made of sheet metal, Electrostatic paint

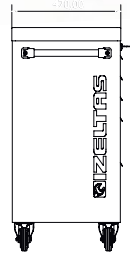
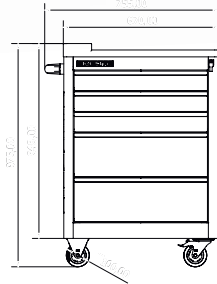

RAL 3020



RAL 5003



RAL 9005

| KOD/CODE | ÇEKMECE DRAWERS | 35 kg | 35 kg | Kg | RENK COLORS | FİYAT TL/Ad |
|--|-----------------|-------|-------|----|-------------|-------------|
| 8235 32 6005 | 5 | 3X | 2X | 56 | | |
| 8235 32 5005 | 5 | 3X | 2X | 56 | | |
| 8235 32 7005 | 5 | 3X | 2X | 56 | | |
| 8235 00 6121 Dolu/Full 118 Parça/Pcs | 5 | 3X | 2X | | | |

(★) İşaretili olan ürünler stoklarla sınırlıdır.
 Limited with stocks.



1. Partner Seri Çekmece/Drawer Kod / Code 8235001072

| KOD CODE | İÇERİK CONTENTS | □ | FİYAT TL/Ad |
|----------|---|----|-------------|
| 1107 | <p>1/4" Altı Köşe Lokma Takımı 1/4" Socket Wrench Set</p> <p>4 - 5 - 6 7 - 8 - 9 - 10 11 - 12 - 13 Altı Köşe Six Points</p> | 15 | |
| 1113 | <p>1/4" Cırcır kolu Ratchet Handle</p> <p>1/4" Mafsal Universal Joint</p> <p>1/4" T Kol Sliding T Handle</p> <p>1/4" Ara Kol Extention Bar 50-100 mm</p> <p>1/2" Lokma Takımı 1/2" Socket Set</p> <p>1/2" Cırcır Kolu 32 Diş Ratchet Handle</p> <p>1/2" Mafsal Universal Joint</p> <p>1/2" T Kol Adaptör Sliding T Handle Adapter</p> <p>1/2" Ara Kol Extention Bar 125-250 mm</p> | 24 | |
| 1507 | <p>1/4" Derin Lokma Tornavida Adaptörü Spindle Handle</p> | 1 | |
| 4900 | <p>12 'li Allen Anahtar Takımı Hex Key Wrench Set 2-2.5-3-3.5-4-5-6-7-8-9-10-12 mm</p> | 12 | |
| 4910 | <p>8 'li Torx Allen Anahtar Takımı Torx Key Wrench T9-T10-T15-T20-T25-T27-T30-T40</p> | 8 | |
| 1108 | <p>1/2" Altı Köşe Derin Lokma Deep Socket Wrench 6 Point 10-13-16-17-18-19 mm</p> | 6 | |
| 1113 | <p>1/2" 16 mm Buji Lokma Anahtar Spark Plug Socket With Rubber</p> | 1 | |
| 2400 | <p>240 mm Üniversal Fort Pense Waterpump Pliers, Universal</p> | 1 | |
| 2500 | <p>250 mm Üniversal Ayarlı Pense Universal Grip</p> | 1 | |

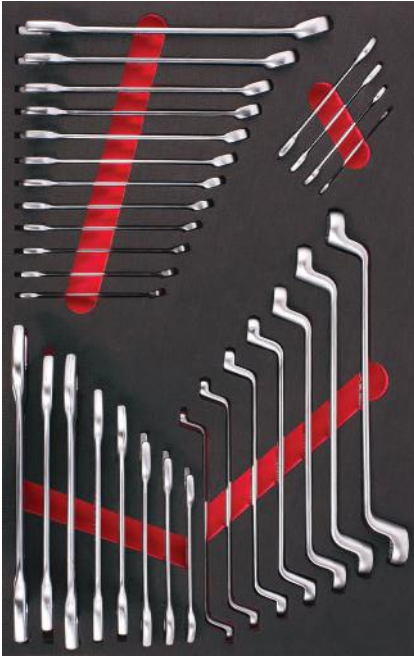

2. Partner Seri Çekmece/Drawer

Kod / Code 8235002031

| KOD CODE | İÇERİK CONTENTS | ☐ | FİYAT TL/Ad |
|-------------|---|----|----------------|
| 0100 | İki Ağız Anahtar Kısa Boy Double Ended Open Jaw Wrench Short Pattern 6x7 - 8x9 - 10x11 - 12x13 14x15 - 16x17 - 18x19 - 20x22 21x23 - 24x26 - 25x28 - 30x32 | 12 | |
| 0320 | Kombine Anahtar Kısa Boy Combination Wrench Short Pattern 8 - 9 - 10 - 11 - 12 - 13 14 - 15 -16- 17 - 19 - 22 | 12 | |
| 0430 | Yıldız Anahtar Ring Wrench 8x9 - 10x11 - 12x13 - 14x15 - 16x17 18x19 - 20x22 | 7 | |



3. Partner Seri Çekmece/Drawer

Kod / Code 8235003017

| KOD CODE | İÇERİK CONTENTS | ☐ | FİYAT TL/Ad |
|-------------|--|---|----------------|
| 4300 | Opak Seri Düz Uçlu Tornavida Screwdriver, Opak Flat 3x80-4x80-4x100-5x125-6x150 | 5 | |
| 4320 | Opak Seri Yıldız Uçlu Tornavida Screwdriver, Opak Philips 4.5x80-6x100 | 2 | |
| 3700 | Yan Keski Opak Seri Side Cutting Pliers 160 mm | 1 | |
| 3020 | Kombine Pense Opak Seri Combination Pliers 180 mm | 1 | |
| 3220 | Düz Kargaburun Opak Seri Nose Pliers Flat 200 mm | 1 | |
| 4770 | Lokma Uçlu Tornavida Nut Spinner 6-7-8-10-13 | 5 | |
| 5500 | Düz Keski Flat Cold Chisel 150 mm | 1 | |
| 5800 | Tesviyecı Çekiçi Machinist's Hammer 500 gr | 1 | |





Ölçü/Size: 410x620x894 mm

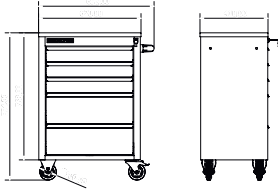

İZELTAS YOUTUBE

8243 32 1003 kodlu takım dolabında sayfa 23'deki sünger muhteviyatlarını kullanabilirsiniz

Sacdan imal edilmiş, Fırın boya
Made of sheet metal, Electrostatic paint



- ✓ Merkezi kilit
- Central locking



- ✓ %100 açılabilir teleskobik raylar.
- %100 extendable telescopic slides



- ✓ Yüksek dayanımlı elektrostatik toz boya.
- High strength electrostatic powder coating

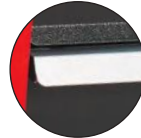

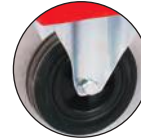

- ✓ Elokssallı alüminyum tutma çantası.
- Handle with anodised aluminum

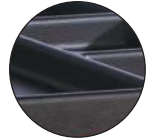

- ✓ 2 sabit, 2 hareketli frenli tekerlek ø 100 mm
- 2 swivel castors with brake 2 fixed castors ø 100 mm



- ✓ 4 bölmeli sağlam ve dayanıklı ABS plastik üst malzeme tabla.
- Resistant and solid top cover with 4 divisions

| KOD/CODE | ÇEKMECE DRAWERS |  |  | DEMONTÉ RAF DISASSEMBLED SHELF |  | RENK COLORS | FİYAT TL/Ad |
|--|-----------------|---|---|--------------------------------|---|----------------------|-------------|
| | | 350x503x82 | 350x503x176 | | | | |
| 8243 32 1003 | 3 | 3x | -- | 2 | 43 | | |
| 8243 32 1005 | 5 | 3X | 2X | -- | 43 | RAL 7016 RAL 3020 | |
| 8243 32 1007 | 7 | 7X | -- | -- | 43 | | |
| 8243 32 2005 | 5 | 3X | 2X | -- | 43 | RAL 7016 RAL 5003 | |
| 8243 32 2007 | 7 | 7X | -- | -- | 43 | | |
| 8243 32 3005 | 5 | 3X | 2X | -- | 43 | RAL 7035 RAL 7016 | |
| 8243 32 3007 | 7 | 7X | -- | -- | 43 | | |
| 8243 00 1096 Dolu/Full 93 Parça/Pcs | 5 | 3X | 2X | -- | | | |
| 8243 00 7096 Dolu/Full 93 Parça/Pcs | 7 | 7X | -- | -- | | RAL 7016 RAL 3020 | |

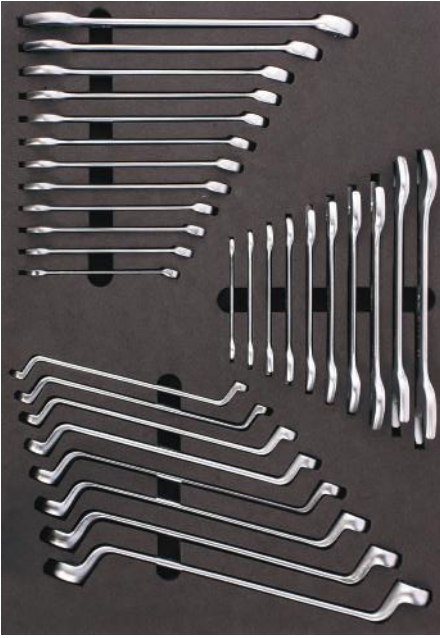
1. Eko Seri Çekmece/Drawer

Kod / Code 8243001030

| KOD/CODE | İÇERİK CONTENTS | ☐ | TL/Ad. |
|----------|---|----|--------|
| 0100 | İki Ağız Anahtar Kısa Boy D/E Open Jaw Wrench Short Pattern 6x7 - 8x9 - 10x11 - 12x13 14x15 - 16x17 - 18x19 - 20x22 - 21x23 - 24x26 | 10 | |
| 0320 | Kombine Anahtar Kısa Boy Combination Wrench Short Pattern 8 - 9 - 10 - 11 - 12 - 13 - 14 - 15 - 16 - 17 - 19 - 22 | 12 | |
| 0430 | Yıldız Anahtar Ring Wrench 6x7 - 8x9 - 10x11 - 12x13 - 14x15 - 16x17 18x19 - 20x22 | 8 | |

2. Eko Seri Çekmece/Drawer

Kod / Code 8243002052

| KOD/CODE | İÇERİK CONTENTS | ☐ | TL/Ad. |
|----------|---|----|--------|
| 1113 | 1113 1/2" 17'li Lokma Takımı Socket Wrench Set 1/2" mm 10 - 11 - 12 - 13 - 14 - 15 - 17 - 19 22 - 24 - 27 - 30 - 32 250 - 250 - 70 1/2" T Kol Adaptör Sliding T Handle Adapte | 17 | |
| 1107 | 1/4" Altı Köşe Lokma Takımı Socket Wrench Set 1/4"mm 4 - 5 - 6 - 7 - 8 - 9 - 10 - 11 - 12 - 13 140 - 115 - 100 - 50 - 38 | 15 | |
| 4900 | Allen Anahtar Takımı Hex Key Wrench Set 2 - 2.5 - 3 - 3.5 - 4 - 5 - 6 - 7 - 8 - 9 - 10 - 12 | 12 | |
| 4770 | Lokma Uçlu Tornavidalar Nutspinners 6 - 7 - 8 - 10 - 13 | 5 | |

3. Eko Seri Çekmece/Drawer

Kod / Code 8243003013

| KOD/CODE | İÇERİK CONTENTS | ☐ | TL/Ad. |
|----------|--|---|--------|
| 4320 | Opak Seri Yıldız Uçlu Tornavida Opak Screwdriver, Phillips 4,5x80-6x100 | 2 | |
| 4300 | Opak Seri Düz Uçlu Tornavida Opak Screwdriver, Flat 4x100-5x125-6x150-8x175 | 4 | |
| 3700 | Yan Keski Opak Seri Side Cutting Pliers 160 mm | 1 | |
| 3020 | Kombine Pense Opak Seri Combination Pliers 180 mm | 1 | |
| 3220 | Kargaburun Düz Uçlu Opak Seri Nose Pliers, Flat 160 mm | 1 | |
| 5500 | Düz Keski Krom Flat Cold Chisel 150 mm | 1 | |
| 5800 | Tesviyeci Çekici Machinist's Hammer 300 gr | 1 | |
| 2510 | Spesiyel Ayarlı Pense / Special Grip 250 mm | 1 | |
| 2400 | Üniversal Fort Pense / Waterpump Pliers Universal 240 mm | 1 | |

Trend Serisi Takım Dolabı (5-7 Çekmeceli) Trend Series Workshop Trolley (5-7 Drawers)



✓ 4 bölmeli sağlam ve dayanıklı
ABS plastik üst malzeme tabla.
● Resistant and solid
top cover with 4 divisions



✓ %100 açılabilir teleskobik raylar.
● %100 extendable telescopic slides

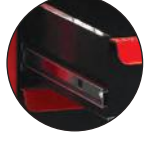

✓ Merkezi kilit
● Central locking



✓ 2 sabit, 2 hareketli
frenli tekerlek ø 100 mm
● 2 swivel castors with brake
2 fixed castors ø 100 mm



✓ Yüksek dayanımlı elektrostatik toz boya
● High strength electrostatic powder coating

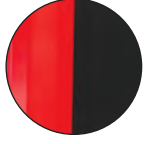

✓ Kendiliğinden açılmayı engelleyen
plastik kilit
● Plastic lock preventing self opening





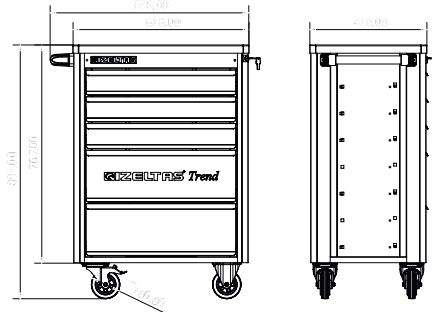

Ölçü/Size: 410x618x894 mm



İZELTAS YOUTUBE

Sacdan imal edilmiş, Fırın boya
Made of sheet metal, Electrostatic paint

| KOD/CODE | ÇEKMECE DRAWERS |  350x503x82 |  350x503x176 |  Kg | RENK COLORS | FİYAT TL/Ad |
|---|--------------------|---|--|---|---|----------------|
| 8244 32 1005 | 5 | 3X | 2X | 43 | | |
| 8244 32 1007 | 7 | 7X | -- | 43 | | |
| 8244 00 5096 Dolu/Full 93 Parça/Pcs | 5 | 3X | 2X | |  | |
| 8244 00 7096 Dolu/Full 93 Parça/Pcs | 7 | 7X | -- | | | |

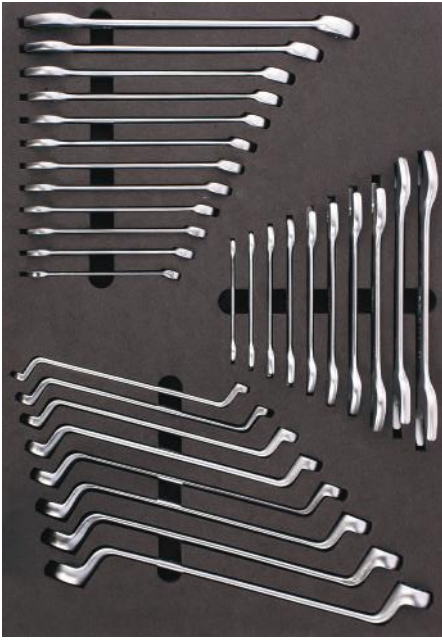
1. Trend Seri Çekmece/Drawer Kod / Code 8244001030

| KOD/CODE | İÇERİK CONTENTS | ☐ | TL/Ad. |
|----------|---|----|--------|
| 0100 | İki Ağız Anahtar Kısa Boy D/E Open Jaw Wrench Short Pattern 6x7 - 8x9 - 10x11 - 12x13 14x15 - 16x17 - 18x19 - 20x22 - 21x23 - 24x26 | 10 | |
| 0320 | Kombine Anahtar Kısa Boy Combination Wrench Short Pattern 8 - 9 - 10 - 11 - 12 - 13 - 14 - 15 - 16 - 17 - 19 - 22 | 12 | |
| 0430 | Yıldız Anahtar Ring Wrench 6x7 - 8x9 - 10x11 - 12x13 - 14x15 - 16x17 18x19 - 20x22 | 8 | |

2. Trend Seri Çekmece/Drawer Kod / Code 8244002052

| KOD/CODE | İÇERİK CONTENTS | ☐ | TL/Ad. |
|----------|--|----|--------|
| 1113 | 1/2" 17'li Lokma Takımı Socket Wrench Set 1/2" mm 10 - 11 - 12 - 13 - 14 - 15 - 17 - 19 22 - 24 - 27 - 30 - 32 250 - 250 - 70 1/2" T Kol Adaptör Sliding T Handle Adapte | 17 | |
| 1107 | 1/4" Altı Köşe Lokma Takımı Socket Wrench Set 1/4"mm 4 - 5 - 6 - 7 - 8 - 9 - 10 - 11 - 12 - 13 140 - 115 - 100 - 50 - 38 | 15 | |
| 4900 | Allen Anahtar Takımı Hex Key Wrench Set 2 - 2.5 - 3 - 3.5 - 4 - 5 - 6 - 7 - 8 - 9 - 10 - 12 | 12 | |
| 4770 | Lokma Uçlu Tornavidalar Nutspinners 6 - 7 - 8 - 10 - 13 | 5 | |

3. Trend Seri Çekmece/Drawer Kod / Code 8244003013

| KOD/CODE | İÇERİK CONTENTS | ☐ | TL/Ad. |
|----------|--|---|--------|
| 4320 | Opak Seri Yıldız Uçlu Tornavida Opak Screwdriver, Phillips 4.5x80-6x100 | 2 | |
| 4300 | Opak Seri Düz Uçlu Tornavida Opak Screwdriver, Flat 4x100-5x125-6x150-8x175 | 4 | |
| 3700 | Yan Keski Opak Seri Side Cutting Pliers 160 mm | 1 | |
| 3020 | Kombine Pense Opak Seri Combination Pliers 180 mm | 1 | |
| 3220 | Kargaburun Düz Uçlu Opak Seri Nose Pliers, Flat 160 mm | 1 | |
| 5500 | Düz Keski Krom Flat Cold Chisel 150 mm | 1 | |
| 5800 | Tesviyecı Çekici Machinist Hammer 300 gr | 1 | |
| 2510 | Spesiyal Ayarlı Pense / Special Grip 250 mm | 1 | |
| 2400 | Üniversal Fort Pense / Waterpump Pliers Universal 240 mm | 1 | |

Takım Dolabı Ahşap Üst Tablalı XXL (7 Çekmeceli) XXL Series Workshop Trolley (7 Drawers)

**YENİ
NEW**

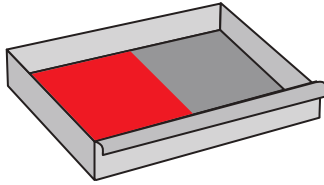

Aşağıda yazılı olan muhteviyatlı süngerlerden her bir çekmeceye İKİ (2) adet yerleştirilebilir.

- | | |
|--------------------------------|-----------------------|
| 1. Premium Seri Çekmece/Drawer | Kod / Code 8245001042 |
| 2. Premium Seri Çekmece/Drawer | Kod / Code 8245002094 |
| 3. Premium Seri Çekmece/Drawer | Kod / Code 8245003014 |
| 4. Premium Seri Çekmece/Drawer | Kod / Code 8245004043 |
| 5. Premium Seri Çekmece/Drawer | Kod / Code 8245005043 |
| 6. Premium Seri Çekmece/Drawer | Kod / Code 8245006009 |
| 1. Pro Seri Çekmece/Drawer | Kod / Code 8241001030 |
| 2. Pro Seri Çekmece/Drawer | Kod / Code 8241002072 |
| 3. Pro Seri Çekmece/Drawer | Kod / Code 8241003051 |
| 4. Pro Seri Çekmece/Drawer | Kod / Code 8241004027 |
| 5. Pro Seri Çekmece/Drawer | Kod / Code 8241005010 |
| 6. Pro Seri Çekmece/Drawer | Kod / Code 8241006018 |
| 1. Garaj Seri Çekmece/Drawer | Kod / Code 8242001030 |
| 2. Garaj Seri Çekmece/Drawer | Kod / Code 8242002072 |
| 3. Garaj Seri Çekmece/Drawer | Kod / Code 8242003010 |
| 4. Garaj Seri Çekmece/Drawer | Kod / Code 8242004018 |
| 5. Garaj Seri Çekmece/Drawer | Kod / Code 8242005011 |
| 1. Partner Seri Çekmece/Drawer | Kod / Code 8235001072 |
| 2. Partner Seri Çekmece/Drawer | Kod / Code 8235002031 |
| 3. Partner Seri Çekmece/Drawer | Kod / Code 8235003017 |

Ölçü/Size: 470x1224x964 mm

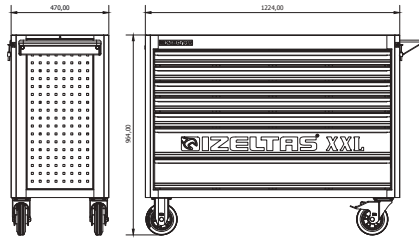

- ✓ 18mm masif üst tabla
- 18 mm solid wood top



- ✓ %100 açılabilir teleskobik raylar.
- %100 extendable telescopic slides



- ✓ Merkezi kilit
- ✓ Mandal sistemi
- ✓ Devrilme emniyet sistemi
- Central lock
- Handgrip Lock system
- Anti tilt system

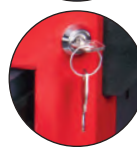

- ✓ Ergonomik sap
- Ergonomic handle



- ✓ 2 sabit, 2 hareketli frenli tekerlek ø 150mm
- 2 swivel castors with brake
- 2 fixed castors ø 150mm



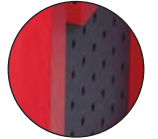

- ✓ Yüksek dayanımlı elektrostatik toz boya.
- High strength electrostatic powder coating.



- ✓ 10 adet seperetör A4 avadanlık
- 10 separators A4 kit



Sacdan imal edilmiş, Fırın boya
Made of sheet metal, Electrostatic paint

| KOD/CODE | ÇEKMECE DRAWERS |  35 kg |  35 kg | Kg | RENK COLORS | FİYAT TL/Ad |
|--------------|-----------------|---|---|----|----------------------|-------------|
| 8246 32 1007 | 7 | 1098x400x60 | 1098x400x135 | | RAL 7016 RAL 3020 | |

Takım Dolabı Ahşap Üst Tablalı Workbench (7 Çekmeceli)
Workbench Series Workshop Trolley (7 Drawers)

**YENİ
NEW**

TAKIM DOLAPLARI
TOOL TROLLEYS
VE TAKIM
ÇANTALARI
TOOL BOXES

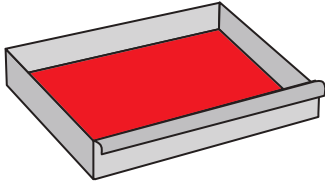

Aşağıda yazılı olan muhteviyatlı süngerlerden her bir çekmeceye BİR (1) adet yerleştirilebilir.

- | | |
|--------------------------------|-----------------------|
| 1. Premium Seri Çekmece/Drawer | Kod / Code 8245001042 |
| 2. Premium Seri Çekmece/Drawer | Kod / Code 8245002094 |
| 3. Premium Seri Çekmece/Drawer | Kod / Code 8245003014 |
| 4. Premium Seri Çekmece/Drawer | Kod / Code 8245004043 |
| 5. Premium Seri Çekmece/Drawer | Kod / Code 8245005043 |
| 6. Premium Seri Çekmece/Drawer | Kod / Code 8245006009 |
| 1. Pro Seri Çekmece/Drawer | Kod / Code 8241001030 |
| 2. Pro Seri Çekmece/Drawer | Kod / Code 8241002072 |
| 3. Pro Seri Çekmece/Drawer | Kod / Code 8241003051 |
| 4. Pro Seri Çekmece/Drawer | Kod / Code 8241004027 |
| 5. Pro Seri Çekmece/Drawer | Kod / Code 8241005010 |
| 6. Pro Seri Çekmece/Drawer | Kod / Code 8241006018 |
| 1. Garaj Seri Çekmece/Drawer | Kod / Code 8242001030 |
| 2. Garaj Seri Çekmece/Drawer | Kod / Code 8242002072 |
| 3. Garaj Seri Çekmece/Drawer | Kod / Code 8242003010 |
| 4. Garaj Seri Çekmece/Drawer | Kod / Code 8242004018 |
| 5. Garaj Seri Çekmece/Drawer | Kod / Code 8242005011 |
| 1. Partner Seri Çekmece/Drawer | Kod / Code 8235001072 |
| 2. Partner Seri Çekmece/Drawer | Kod / Code 8235002031 |
| 3. Partner Seri Çekmece/Drawer | Kod / Code 8235003017 |

Ölçü/Size: 500x1150x991 mm

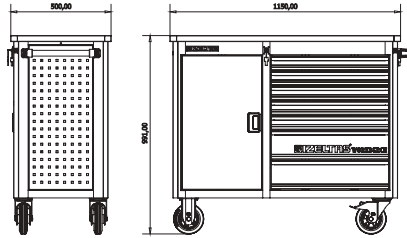

- ✓ 30 mm masif ahşap üst tabla
- 30 mm solid wood top



- ✓ %100 açılabilir teleskobik raylar.
- %100 extendable telescopic slides



- ✓ Merkezi kilit
- ✓ Mandal sistemi
- ✓ Devrilme emniyet sistemi
- Central lock
- Handgrip Lock system
- Anti tilt system



- ✓ Standard tutma sapı
- Standard handle



- ✓ 2 sabit, 2 hareketli frenli tekerlek ø 150mm
- 2 swivel castors with brake
- 2 fixed castors ø 150mm





- ✓ Yüksek dayanımlı elektrostatik toz boya.
- High strength electrostatic powder coating.

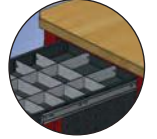

- ✓ 4 kısa, 2 uzun seperetör
- 4 Short, 2 long separators



Sacdan imal edilmiş, Fırın boya
Made of sheet metal, Electrostatic paint

| KOD/CODE | ÇEKMECE DRAWERS |  |  |  | RENK COLORS | FİYAT TL/Ad |
|----------|-----------------|---|---|---|-------------|-------------|
| | | 400x548x60 | 400x548x134 | | | |

8247 32 1007

7

5X

2X

RAL 7016
RAL 3020

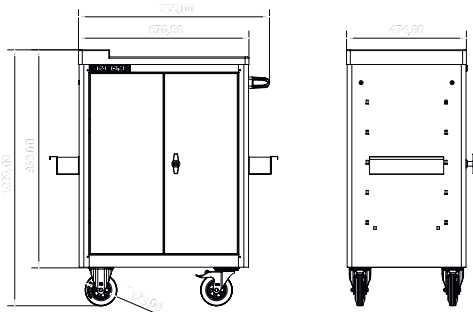
Vagon Serisi Takım Dolabı
Wagon Series Workshop Trolley**Ölçü/Size: 474x670x1020 mm**

- ✓ 8 Bölmeli, sağlam ABS tabla
- Durable ABS worktop with divisions

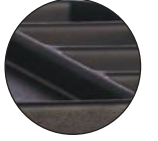

- ✓ Kilit T kol
- Locked T-handle



- ✓ 2 Sabit, 2 hareketli frenli tekerlek ø 125mm
- 2 swivel castors with brake 2 fixed castors ø 125 mm



- ✓ Yüksek dayanımlı elektrostatik toz boya.
- High strength electrostatic powder coating



- ✓ 2X ayarlanabilir raf (10 adet seperatör ile)
- 2x adaptable shelves with separator 10 pcs



- ✓ Standard tutma sapı
- Standard handle



- ✓ 2X avadanlık
- 2X tin holder

**Sacdan imal edilmiş, Fırın boya**
Made of sheet metal, Electrostatic paint

| KOD/CODE | Ölçü / SIZE (mm) | Kg | RENK COLORS | FİYAT TL/AD |
|----------|------------------|----|-------------|-------------|
|----------|------------------|----|-------------|-------------|

8210 32 6001

474x670x1020

45

RAL 7016
RAL 3020

8160
Takım Dolabı
Tool Cabinet

- ✓ Kollu kilit
- Locked T-handle



- ✓ %100 açılabilir teleskopik raylar.
- %100 extendable telescopic slides



- ✓ 4 hareketli frenli tekerlek ø 50mm
- 4 swivel castors with brake ø 50mm



- ✓ Yüksek dayanımlı elektrostatik toz boya.
- High strength electrostatic powder coating



- ✓ Avadanlık x2
- Bottle and tins holder x2



- ✓ Askılık x4
- Hanger x4



- ✓ Özel askılık x4
- Special hanger x4



- ✓ Anahtar askısı x1
- Hanger for wrenches x1

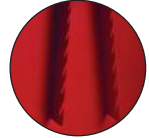

- ✓ Özel avadanlık x1
- Special tin holder x1

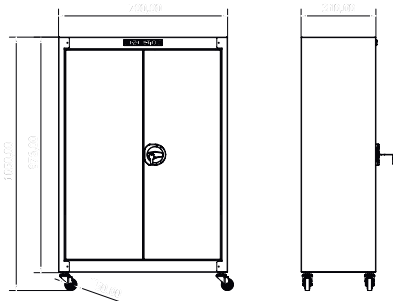

- ✓ Matkap ucu tutucu x1
- Drill bits holder x1

Ölçü/Size: 310x700x1050 mm

Sardan imal edilmiş, Fırın boya
Made of sheet metal, Electrostatic paint

| KOD/CODE | 20 kg | Ölçü / SIZE (mm) | Kg | COLORS | FİYAT TL/Ad. |
|------------|-------|------------------|----|--------|--------------|
| 228x567x58 | | | | | |

8160 32 6001

3x

310x700x1050

35

 RAL 7016
RAL 3020

Demonte Mini Servis Arabası
Disassembled Mini Service Trolley

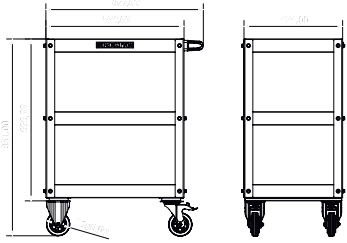

Çelik konstrüksiyon
Steel construction

- **3X Kauçuk Kaydırmaz Mat**
3X Rubber Anti Slipping Mats
- **2X Sabit, 2X Hareketli Frenli Tekerlek (ø 100 mm)**
2X Fixed, 2X Swivel Castors with Brake (ø 100 mm)
- **Sağlam sac metal yapı, Her raf 50 Kg taşır.**
Robust sheet-steel construction, Loading capacity per shelf 50 Kg

| KOD/CODE |  420x590x57 | Ölçü / SIZE (mm) |  Kg | COLORS | FİYAT TL/Ad. |
|----------|---|------------------|---|--------|--------------|
|----------|---|------------------|---|--------|--------------|

8550 34 8001

3X

424x594x851

18

RAL 9005
RAL 3020

8550

Demonte Mini Servis Arabası (kapalı)
Disassembled Mini Service Trolley (closed)

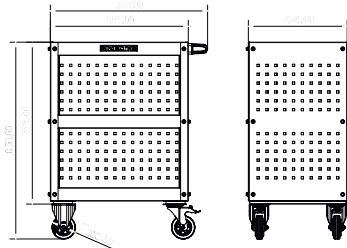

Çelik konstrüksiyon
Steel construction

- **3X Kauçuk Kaydırmaz Mat**
3X Rubber Anti Slipping Mats
- **2X Sabit, 2X Hareketli Frenli Tekerlek (ø 100 mm)**
2X Fixed, 2X Swivel Castors with Brake (ø 100 mm)
- **Sağlam sac metal yapı, Her raf 50 Kg taşır.**
Robust sheet-steel construction, Loading capacity per shelf 50 Kg
- **Arabanın yanları ve arkasında kare askı delikleri**
Square-shaped perforation on the side panels and back panel offers individual fastening

| KOD/CODE |  420x590x57 | Ölçü / SIZE (mm) |  Kg | COLORS | FİYAT TL/Ad. |
|----------|---|------------------|---|--------|--------------|
|----------|---|------------------|---|--------|--------------|

8550 34 8002

3X

424x594x851

23

RAL 9005
RAL 3020

8545

Taşıma Arabası Platform Wagon

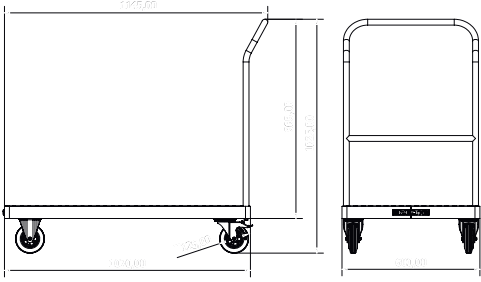

Çelik konstrüksiyon
Steel construction

- **12mm PVC kaplı kontrplak Tabla**
12mm PVC coated plywood
- **2X Sabit, 2X Hareketli Frenli Tekerlek (ø 125mm)**
2X Fixed, 2X Swivel Castors with Brake (ø 125mm)
- **Sağlam sac metal yapı, Her raf 310 Kg taşır.**
Robust sheet-steel construction, Loading capacity per shelf 310 Kg

| KOD/CODE | Ölçü / SIZE (mm) | Kg | COLORS | FİYAT TL/Ad. |
|----------|------------------|----|--------|--------------|
|----------|------------------|----|--------|--------------|

8545 34 1005

600x1145x1025

38

RAL 9005

8550

Servis Arabası (Büyük Boy) Service Trolley (Large Size)

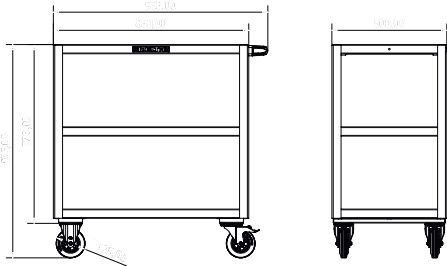

Çelik konstrüksiyon
Steel construction

- **3X Kauçuk Kaydırmaz Mat**
3X Rubber Anti Slipping Mats
- **2X Sabit, 2X Hareketli Frenli Tekerlek (ø 125 mm)**
2X Fixed, 2X Swivel Castors with Brake (ø 125 mm)
- **Sağlam sac metal yapı, Her raf 75 Kg taşır.**
Robust sheet-steel construction, Loading capacity per shelf 75 Kg

| KOD/CODE | 75 kg | Ölçü / SIZE (mm) | Kg | COLORS | FİYAT TL/Ad. |
|----------|-------|------------------|----|--------|--------------|
|----------|-------|------------------|----|--------|--------------|



494x844x40

8550 34 6001

3X

500x850x935

37

RAL 3020

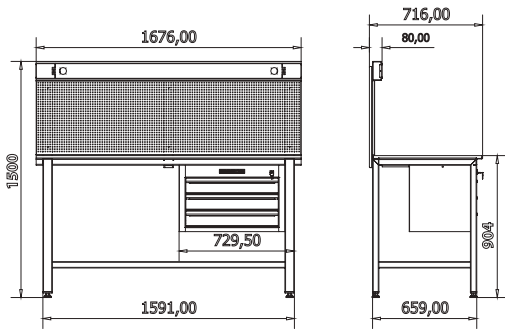
Servis Masası (Panolu)
Work Bench (With Panel)

- **Merkezi kilit sistemi, mandal sistemi**
Central locking system, handgrip lock system
- **Kaynaklı sağlam tasarım**
Robust welded design
- **%100 Açılabilir teleskobik raylar**
100% extendable telescopic slides
- **Yüksek dayanımlı elektrostatik toz boya.**
High strength electrostatic powder paint
- **Delikli panel (220 V prizler ile).**
Perforated panel with electrical plugs 220 V

Çelik Konstrüksiyon ve zor koşullarda çalışmaya elverişli
Özel Plywood ahşap tezgah
Strong and durable steel construction and Plywood bench

| KOD/CODE |  | Ölçü / SIZE (mm) |  Kg | COLORS | FIYAT TL/Ad. |
|----------|---|------------------|--|--------|--------------|
|----------|---|------------------|--|--------|--------------|

8500 34 6001

3X

720x1680x1495

102

RAL 7016
RAL 3020

8501

Servis Masası (Panosuz) Work Bench (Without Panel)

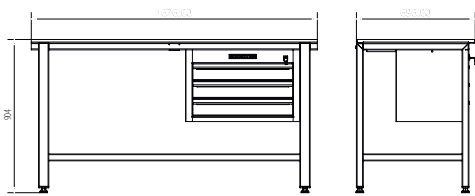

- **Merkezi kilit sistemi, mandal sistemi**
Central locking system, handgrip lock system
- **Kaynaklı sağlam tasarım**
Robust welded design
- **%100 Açılabilir teleskobik raylar**
100% extendable telescopic slides
- **Yüksek dayanımlı elektrostatik toz boya.**
High strength electrostatic powder paint

Çelik konstrüksiyon ve zor koşullarda çalışmaya elverişli
Özel Plywood ahşap tezgah
Strong and durable steel construction and Plywood bench

| KOD/CODE |  | Ölçü / SIZE (mm) |  Kg | COLORS | FİYAT TL/Ad. |
|----------|---|------------------|--|--------|--------------|
| | 348x548x90 | | | | |

8501 34 6001

3X

700x1680x900

84

RAL 7016
RAL 3020

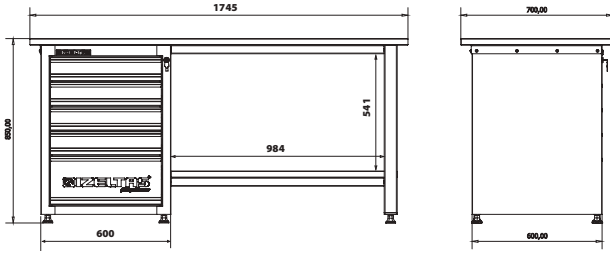
Demonte Atölye Masası
Disassembled Workbench

- ✓ %100 açılabilir teleskobik raylar.
- %100 extendable telescopic slides





- ✓ Merkezi kilit
- ✓ Mandal sistemi
- Central lock
- Handgrip Lock system



- **Demonte sağlam tasarım**
Robust disassembled design
- **30mm masif ahşap**
30 mm solid wood
- **Ayarlanabilir ayaklar**
Height adjustable feet

Çelik konstrüksiyon
Steel construction

| KOD/CODE | ÇEKMECE DRAWERS |  |  |  Kg | RENK COLORS | FİYAT TL/Ad |
|--------------|--------------------|---|---|---|----------------|----------------|
| 8502 34 6002 | 5 | 490x400x107 | 490x400x221 | | | |

8502 34 6002

5

4X

1X

RAL 7016
RAL 3020



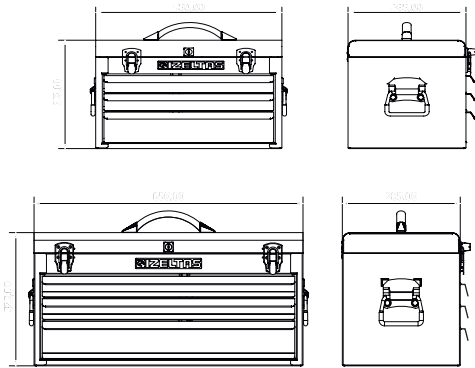

TANIM DOLAPLARI
VE TANIM
ÇANTALARI

TOOL TROLLEYS,
TOOL BOXES

Çekmeceli Alet Sandığı
Tool Chest With Drawers

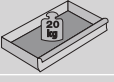
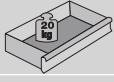
Sacdan imal edilmiş, Fırın boya
Made from metal sheet, Electrostatic paint

| KOD/CODE | Ölçü / SIZE (mm) | ÇEKMECE DRAWERS |  2x |  1x |  Kg | FİYAT TL/Ad |
|--------------|------------------|--------------------|---|---|---|----------------|
| 8320 33 1001 | 285x450x322 | 3X | 238x370x47 | 238x370x87 | 16 | |
| 8320 33 1003 | 285x650x322 | 3X | 238x570x47 | 238x570x87 | 20 | |

8410

Takım Çantası (3 Gözlü) Tool Box (3 Trays)

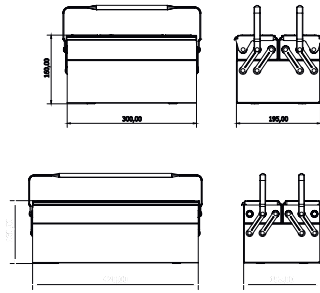

Sacdan imal edilmiş, Fırın boya
Made from metal sheet, Electrostatic paint

| KOD CODE | Ölçü / SIZE (mm) | g | Ad | FİYAT TL/Ad |
|--------------|------------------|------|----|-------------|
| 8410 33 6103 | 195x300x160 | 2400 | 1 | |
| 8410 33 6203 | 195x420x160 | 3000 | 1 | |

8420

Takım Çantası (5 Gözlü) Tool Box (5 Trays)

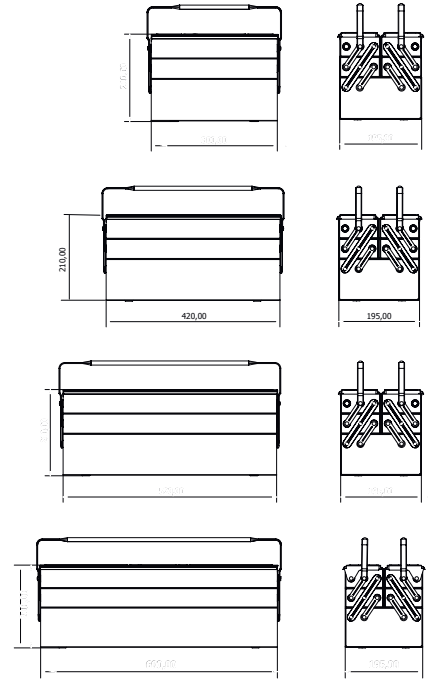
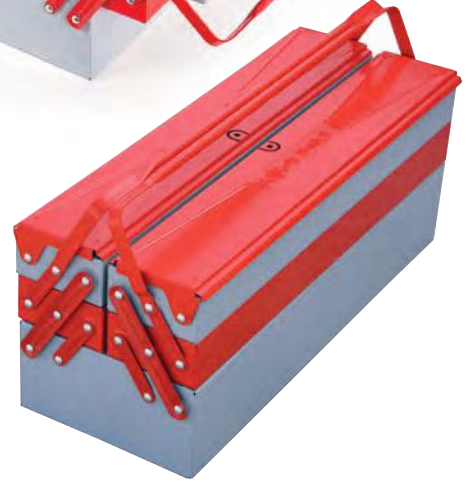

Sacdan imal edilmiş, Fırın boya
Made from metal sheet, Electrostatic paint

| KOD CODE | Ölçü / SIZE (mm) | g | Ad | FİYAT TL/Ad |
|--------------|------------------|------|----|-------------|
| 8420 33 6105 | 195x300x210 | 3200 | 1 | |
| 8420 33 6205 | 195x420x210 | 4200 | 1 | |
| 8420 33 6305 | 195x520x210 | 5000 | 1 | |
| 8420 33 6405 | 195x600x210 | 5600 | 1 | |

(*) İşaretili olan ürünler stoklarla sınırlıdır.
Limited with stocks.

Takım Çantası (5 Gözlü)
Tool Box (5 Trays)**8420 00 5063****Mekanikçi Takım Çantası (62 Parça, 5 Gözlü)**
Tool Box for Mechanician (62 Pcs, 5 Trays)**8420 00 5046****Elektrikçi Takım Çantası (45 Parça, 5 Gözlü)**
Tool Box for Electrician (45 Pcs, 5 Trays)**8420 00 5028****Tesisatçı Takım Çantası (28 Parça, 5 Gözlü)**
Tool Box for Plumbers (28 Pcs, 5 Trays)

8420 00 5063
Mekanikçi Takım Çantası (5 Gözlü)
Tool Box for Mechanician (5 Trays)

| KOD CODE | ÖLÇÜ SIZE mm |  | TL/Ad. |
|----------|--------------|---|--------|
|----------|--------------|---|--------|

8420 00 5063 195x420x210
DOLU / FULL 62

| KOD CODE | İÇERİK CONTENTS |  |
|----------|-----------------|---|
|----------|-----------------|---|

05881 50 015 **5 m Krom Şerit Metre**
Chrom Case Steel,
Measuring tapes 1

4785 19 6330 **6.3x30 Kısa Bits Tutucu Tornavida**
Screwdriver, Magnetic
Bit Holder (Short) 1

4800 00 8110 **10 'Lu Bits Takım**
Bits Set 10 (Pcs) 25 mm 10

4320 **Opak Seri Yıldız Uçlu Tornavida**
Screwdriver, Opak, Philips
4.5x80-6x100 2

4300 **Opak Seri Düz Uçlu Tornavida**
Screwdriver, Opak, Flat
3x80-4x100-5x125-6x150 4

4550 17 0135 **135mm Kontrol Kalem**
Voltage Tester 1

2400 11 0240 **240mm Ünsersal Fort Pense**
Water Pump Pliers Universal 1

1113 **1/2" Lokma Anahtar**
Socket Wrench
10-11-12-13-14-15-17
19-22-24-27-30-32 13

1513 06 4250 **1/2" Uzun Ara Kol**
Extension Bar Long 250 mm 1

1513 06 4070 **1/2" Mafsal**
Universal Joint 70 mm 1

1513 06 0032 **1/2" Cırcır Kol 32 Dişli**
Ratchet Handle 250 mm 1

4900 00 3112 **12 'Li Allen Anahtar Takım 6 Köşe**
Hex Key Wrench Set
2-2.5-3-3.5-4-5-6-7-8-9-10-12 12

0320 **Kısa Kombine Anahtar**
Combination Wrench
Short Pattern
8-9-10-11-12-13
14-17-19-22 10

3700 16 2160 **160mm Yan Keski Opak Seri**
Side Cutting Nippers,
Opak insulated 1

3020 12 2180 **180mm Kombine Pense Opak Seri**
Combination Pliers,
Opak Insulated 1

3220 13 2160 **160mm Düz Kargaburun Opak Seri**
Nose Pliers,
Flat, Opak Insulated 1

8420 00 5046
Elektrikçi Takım Çantası (5 Gözlü)
Tool Box for Electrician (5 Trays)

| KOD CODE | ÖLÇÜ SIZE mm |  | TL/Ad. |
|----------|--------------|---|--------|
|----------|--------------|---|--------|

8420 00 5046 195x420x210
DOLU / FULL 45

| KOD CODE | İÇERİK CONTENTS |  |
|----------|-----------------|--|
|----------|-----------------|--|

05881 50 005 **5m Plastik Şerit Metre**
Plastic Measuring Tape 1

4783 19 6120 **1000V İzoleli Manyetik Bits Tutucu Tornavida**
Screwdriver, Magnetic
Bit Holder Insulated
6.3x120 1

4800 00 8106 **6 'Lı Bits Takım**
Bits Set (6 Pcs) 6

0600 01 1010 **10" Kurbağacık Anahtar**
Adjustable Jaw Wrench 1

4140-4145 **1000V İzoleli Elektrikçi Düz, Yıldız Tornavida**
Insulated Electrician type Flat
Screwdriver, Phillips 1000V
4x100-5.5x125 - 4.5x80-6x100 4

4550 17 0135 **135mm Kontrol Kalem**
Voltage Tester 1

4550 17 0190 **190mm Kontrol Kalem**
Voltage Tester 1

4773 **1000V Süngüsü İzoleli Lokma Uçlu Tornavida**
Nut Spinner, Electrician Blade
Insulated 1000V
6-7-8-10-13 5

0340 **Cırcır Kombine Anahtar**
Combination Wrench
With Ratchet
8-10-12-13-17-19 6

4900 00 3110 **10 'Lu Allen Anahtar Takımı (mm)**
Hex Key Wrench Set 10 pcs
2-2.5-3-4-5-6-7-8-9-10 10

4500-4520 **Klemens Tornavida**
Screwdriver, Electronic
3x80-3x100-3x125-3x60-4x80 5

3700 16 6160 **1000V İzoleli Elektrikçi 160mm Yan Keski**
Insulated Electrician Type Side
Cutter 1000V 1

3020 12 6180 **1000V İzoleli Elektrikçi 180mm Kombine Pense**
Insulated Electrician Type
Combination Plier 1000V 1

3220 13 6160 **1000V İzoleli Elektrikçi 160mm Kargaburun Düz**
Insulated Electrician Type Nose
Plier 1000V 1

8420 00 5028
Tesisatçı Takım Çantası (5 Gözlü)
Tool Box for Plumbers (5 Trays)

| KOD CODE | ÖLÇÜ SIZE mm |  | TL/Ad. |
|----------|--------------|---|--------|
|----------|--------------|---|--------|

8420 00 5028 195x420x210
DOLU / FULL 28

| KOD CODE | İÇERİK CONTENTS |  |
|----------|-----------------|---|
|----------|-----------------|---|

0600 01 1010 **10" Kurbağacık Anahtar**
10" Adjustable Jaw Wrench, 1

0600 01 1012 **12" Kurbağacık Anahtar**
12" Adjustable Jaw Wrench, 1

2400 11 0240 **240 Ünsersal Fort Pense**
240 Waterpump Pliers,
Universal 1

2100 10 0012 **12" Stilson Boru Anahtarı**
12" Pipe Wrench, Stilson 1

4901 22 1270 **1/2" Sae Allen Anahtar**
1/2" Hex Key Wrench SAE 1

4300 17 6150 **Opak Seri Düz Uçlu Tornavida**
Screwdriver,
Opak, Slotted 6x150 1

4320 18 6100 **Opak Seri Yıldız Uçlu Tornavida**
Screwdriver, Opak, Phillips
6x100 1

5800 25 0500 **500gr Çekiç**
Machinist Hammer 1

5500 23 0200 **200mm Düz Keski**
Flat Cold Chisel 1

3830 15 0250 **250mm Betoncu Kerpeten**
Tower Pincers 1

4900 00 3112 **12 'Li Allen Anahtar Takımı (mm)**
Hex Key Wrench Set 12 pcs
2-2.5-3-3.5-4-5-6-7-8-9-10-12 12

0588 15 0015 **5m Krom Şerit Metre**
Chrom Case Steel Measuring
Tape 1

2201 10 0010 **1" Maşalı Boru Anahtarı**
1" Pipe Wrench 1

3700 16 2160 **160mm Yan Keski Opak Seri**
Side Cutting Nippers, Opak
insulated 1

3020 12 2180 **180mm Kombine Pense Opak Seri**
Combination Pliers, Opak
Insulated 1

3220 13 2160 **160mm Düz Kargaburun Opak Seri**
Nose Pliers, Flat, Opak Insulated 1

Plastik Takım Çantaları
Plastic Tool Boxes

| KOD CODE | inch | ÖLÇÜ SIZE mm | g | TL/ Ad. |
|--------------|------|--------------------|------|------------|
| 8440 33 1016 | 16" | 413x212x186 | 1207 | 4 |
| 8440 33 1019 | 19" | 480x267x242 | 1922 | 4 |
| 8440 33 1022 | 22" | 564x310x310 | 2870 | 4 |

Tekerlekli Plastik Takım Çantası
Plastic Mobile Tool Chest

| KOD CODE | inch | ÖLÇÜ SIZE mm | g | TL/ Ad. |
|--------------|------|--------------------|------|------------|
| 8445 33 1028 | 28" | 380x595x420 | 5900 | 1 |

Hobby Set Oto Tipi (13 Parça)
Hobby Set Auto Type (13 pcs)

| KOD CODE | İÇERİK CONTENTS | TL/ Ad. |
|----------|--|------------|
| 0100 | İki Ağız Anahtar (Kısa Boy) Duble Ended Open Jaw Wrench Short Pattern 8x9-10x11-12x13-14x15-16x17-18x19 | 6 |
| 1841 | 21 mm Kovan Anahtar Bir Ağız ve Mil Single Ended Tubular Socket Wench | 1 |
| 2400 | 240 mm Ünlversal Fort Pense Waterpump Pliers Universal | 1 |
| 3020 | 160 mm Kombine Pense Opak Seri Combination Pliers | 1 |
| 4240 | Değişken Uçlu Tornavida Takımı Screwdriver Set Reversible 4.5x80 - 6x80 | 2 |
| 5800 | 200 gr Tesviyeci Çekiç / Machinist Hammer | 1 |
| 6350 | 300 mm Levye Oluklu / Tyre Lever Straight | 1 |

Bakım Onarım Seti (5 Parça)
Maintenance Set (5 Pcs)

| KOD CODE | İÇERİK CONTENTS | TL/ Ad. |
|--------------|---|------------|
| 3020 12 3160 | 160 mm Kombine Pense Kraft Seri Combination Pliers | 1 |
| 3220 13 3160 | 160 mm Kargaburun Düz Uçlu Kraft Seri Nose Pliers Flat | 1 |
| 3700 16 3140 | 140 mm Yan Keski Kraft Seri Side Cutting Pliers | 1 |
| 4100 17 5100 | 5x100 Kraft Seri Düz Uçlu Tornavida Screwdriver Kraft, Flat | 1 |
| 4120 18 4580 | 4.5x80 Kraft Seri Yıldız Uçlu Tornavida Screwdriver Kraft, Phillips | 1 |

(★) İşaretili olan ürünler stoklarla sınırlıdır.
Limited with stocks.

★8793 00 1014
Bakım Seti (14 Parça)
Maintenance Set (14 Pcs)

| KOD CODE | İÇERİK CONTENTS | ☐ | TL/Ad. |
|----------|---|---|--------|
| 0130 | İki Ağız Anahtar (Uzun Boy) Duble Ended Open Jaw Wrench Long Pattern 6x7-8x9-10x11-12x13-14x15-16x17-18x19-20x22 | 8 | |
| ★3220 | 160 mm Kargaburun Düz Uçlu Ergonomik Seri Nose Pliers Flat | 1 | |
| ★3700 | 140 mm Yan Keski Ergonomik Seri Side Cutting Pliers | 1 | |
| ★4350 | Ergonomik Seri Düz Uçlu Tornavida 4x100-6x100 Screwdriver Ergonomic, Flat | 2 | |
| ★4370 | Ergonomik Seri Yıldız Uçlu Tornavida 4.5x80-6x100 Screwdriver Ergonomic, Phillips | 2 | |

8786 00 1003
Doğada Set (3 Parça)
Outdoor Set (3 Pcs)

 İZELTAS USTA İŞİ
SOHBETLER

| KOD CODE | İÇERİK CONTENTS | ☐ | TL/Ad. |
|--------------|------------------------------------|---|--------|
| 6710 27 0230 | Bağ Makası Lüks / Pruning Shears | 1 | |
| 6735 27 0300 | Dal Budama Testeresi / Pruning Saw | 1 | |
| 6410 25 0800 | Nacak / Hatchet | 1 | |

8779 00 8741
Motosiklet Bakım Seti
Biker Set (42 Pcs)

| KOD CODE | İÇERİK CONTENTS | ☐ | TL/Ad. |
|--------------|--|----|--------|
| 0100 01 0809 | İki Ağız Anahtar Kısa Boy 08x09 Duble Ended Open Jaw Wrench Short Pattern mm | 1 | |
| 0100 01 1011 | İki Ağız Anahtar Kısa Boy 10x11 Duble Ended Open Jaw Wrench Short Pattern mm | 1 | |
| 0100 01 1213 | İki Ağız Anahtar Kısa Boy 12x13 Duble Ended Open Jaw Wrench Short Pattern mm | 1 | |
| 0100 01 1415 | İki Ağız Anahtar Kısa Boy 14x15 Duble Ended Open Jaw Wrench Short Pattern mm | 1 | |
| 0100 01 1617 | İki Ağız Anahtar Kısa Boy 16x17 Duble Ended Open Jaw Wrench Short Pattern mm | 1 | |
| 0600 01 1008 | Kurbağacık Anahtar 8" Adjustable Wrench 8" | 1 | |
| 1107 06 0006 | 1/4" Altı Köşe 6 mm Lokma Anahtar Socket Wrench 6 Point (6mm) | 1 | |
| 1107 06 0008 | 1/4" Altı Köşe 8 mm Lokma Anahtar Socket Wrench 6 Point (8mm) | 1 | |
| 1107 06 0010 | 1/4" Altı Köşe 10 mm Lokma Anahtar Socket Wrench 6 Point (10mm) | 1 | |
| 1107 06 0011 | 1/4" Altı Köşe 11 mm Lokma Anahtar Socket Wrench 6 Point (11mm) | 1 | |
| 1107 06 0012 | 1/4" Altı Köşe 12 mm Lokma Anahtar Socket Wrench 6 Point (12mm) | 1 | |
| 1107 06 0013 | 1/4" Altı Köşe 13 mm Lokma Anahtar Socket Wrench 6 Point (13mm) | 1 | |
| 1107 06 5010 | 1/4" Bits Tutucu Lokma Mıknatıslı Bit Holder Socket | 1 | |
| 4240 00 7102 | Değişken Uçlu Tornavida Takımı Screwdriver Set Reversible | 2 | |
| 4800 00 8106 | 6'lı Bits Set (25 mm) Bit Set 6 Pcs | 6 | |
| 4900 00 3110 | Allen Anahtar Takımı 10 Parça Hex Set Wrench Set (10 Pcs) | 10 | |
| 4910 00 7108 | Torx Allen Anahtar Takımı 8 Parça Torx Key Wrench Set (8 Pcs) | 8 | |
| 1507 06 0050 | 1/4" Ara Kol 50 mm Extension Bar 50 mm | 1 | |
| 1507 06 2140 | 1/4" Cırcır Kolu 140 mm Ratchet Wrench 140 mm | 1 | |
| 1507 06 4080 | 1/4" Derin Tornavida Adaptörü Spindle Handle | 1 | |

**ŞABLON
BILLET****FİNAL ÜRÜN
FINAL PRODUCT**

ANAHTARLAR

WRENCHES

İki Ağız Anahtarlar
Open Jaw Wrenches

Kombine Anahtarlar
Combination Wrenches

Yıldız Anahtarlar
Ring Wrenches

Çakma Anahtarlar
Slugging Wrenches

Kurbağacık Anahtarlar
Adjustable Wrenches

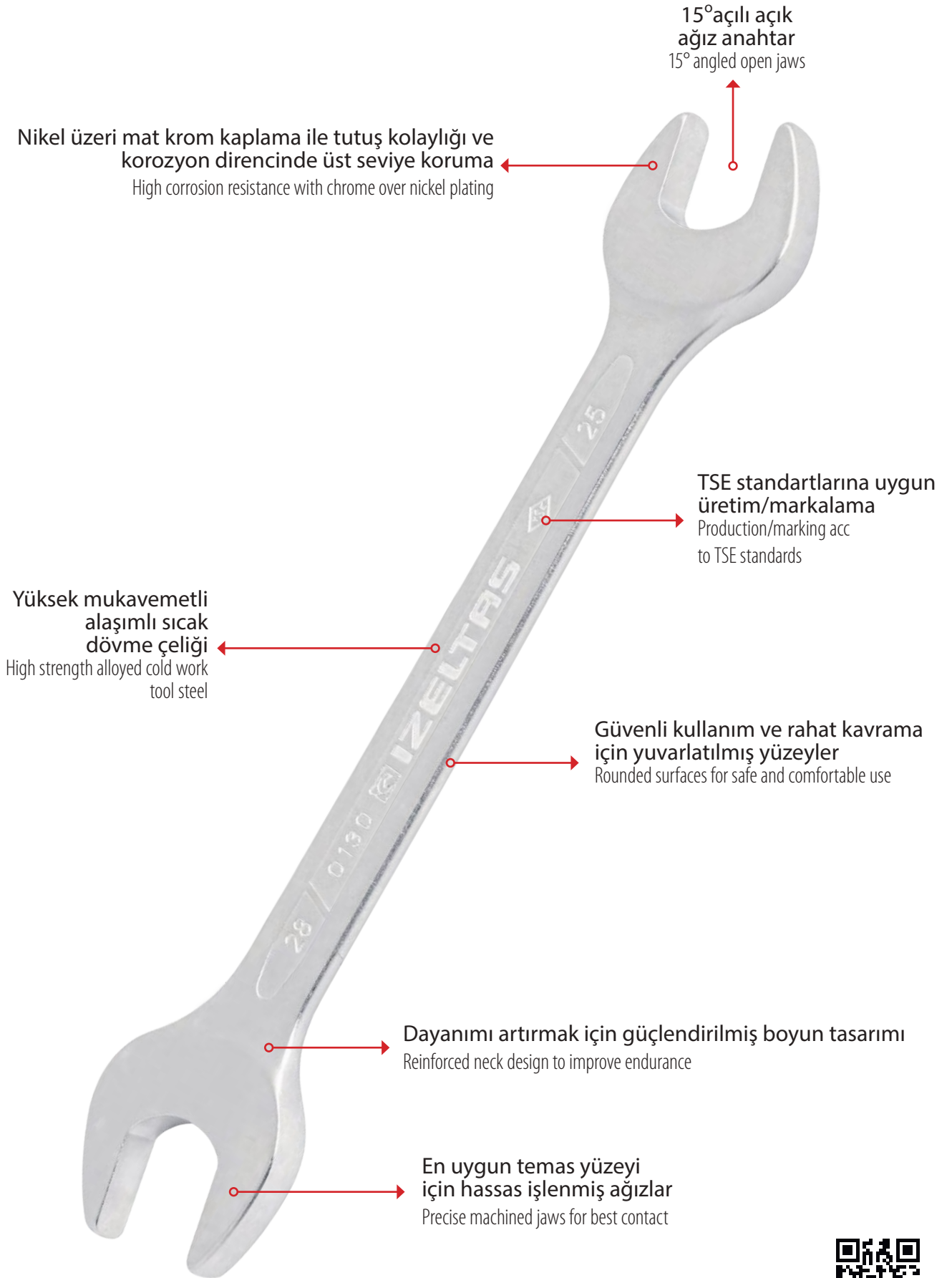

İKİ AĞIZ ANAHTAR / DOUBLE ENDED OPEN JAW WRENCH

İZELTAS YOUTUBE

(★) İşaretili olan ürünler stoklarla sınırlıdır.
Limited with stocks.

İki Ağız Anahtar Kısa Boy (mm)
Double Ended Open Jaw Wrench Short Pattern (mm)

 TS 81-6
 DIN 895

IZELTAS YOUTUBE

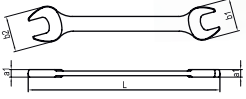
 Krom vanadyum, Krom kaplı
 Chrom vanadium, Chrom plated

| KOD CODE | mm | L mm | a1 mm | b1 mm | b2 mm | g | TL/Ad. |
|--------------|-------|------|-------|-------|-------|-----|--------|
| 0100 01 0405 | 4x5 | 97 | 3.5 | 11 | 12.5 | 15 | 10 |
| 0100 01 0607 | 6x7 | 97 | 3.5 | 14 | 16 | 18 | 10 |
| 0100 01 0809 | 8x9 | 108 | 4 | 18 | 20 | 30 | 10 |
| 0100 01 0810 | 8x10 | 117 | 4.5 | 18 | 22 | 33 | 10 |
| 0100 01 1011 | 10x11 | 120 | 4.6 | 22 | 24 | 41 | 10 |
| 0100 01 1012 | 10x12 | 120 | 4.6 | 22 | 26 | 35 | 10 |
| 0100 01 1013 | 10x13 | 120 | 4.6 | 22 | 28 | 38 | 10 |
| 0100 01 1213 | 12x13 | 133 | 5.2 | 26 | 28 | 57 | 10 |
| 0100 01 1214 | 12x14 | 147 | 5.2 | 26 | 30 | 59 | 10 |
| 0100 01 1314 | 13x14 | 147 | 5.2 | 28 | 30 | 66 | 10 |
| 0100 01 1415 | 14x15 | 147 | 5.8 | 30 | 32 | 78 | 10 |
| 0100 01 1317 | 13x17 | 162 | 6.2 | 28 | 36 | 80 | 10 |
| 0100 01 1417 | 14x17 | 162 | 6.2 | 30 | 36 | 90 | 10 |
| 0100 01 1617 | 16x17 | 162 | 6.2 | 34 | 36 | 109 | 10 |
| 0100 01 1719 | 17x19 | 178 | 7 | 36 | 40 | 143 | 10 |
| 0100 01 1819 | 18x19 | 178 | 7 | 38 | 40 | 144 | 10 |
| 0100 01 1922 | 19x22 | 195 | 7.4 | 40 | 46 | 175 | 10 |
| 0100 01 2022 | 20x22 | 195 | 7.4 | 42 | 46 | 196 | 10 |
| 0100 01 2123 | 21x23 | 213 | 7.7 | 44 | 48 | 230 | 10 |
| 0100 01 2224 | 22x24 | 213 | 8 | 46 | 50 | 239 | 10 |
| 0100 01 2426 | 24x26 | 232 | 8.2 | 50 | 54 | 297 | 10 |
| 0100 01 2427 | 24x27 | 232 | 8.2 | 50 | 56 | 296 | 10 |
| 0100 01 2528 | 25x28 | 248 | 8.6 | 52 | 57.5 | 366 | 10 |
| 0100 01 2732 | 27x32 | 265 | 9 | 56 | 66 | 415 | 10 |
| 0100 01 3032 | 30x32 | 265 | 9 | 62 | 66 | 465 | 10 |

ÖZEL SERİLER (adet ve termin süresi isteyiniz)
SPECIAL SERIES (ask for quantity and delivery terms)

| | | | | | | | |
|--------------|-------|-----|-----|----|----|-----|----|
| 0100 01 0608 | 6x8 | 97 | 3.5 | 14 | 18 | 20 | 10 |
| 0100 01 0708 | 7x8 | 108 | 3.5 | 16 | 18 | 20 | 10 |
| 0100 01 0709 | 7x9 | 108 | 4 | 16 | 20 | 25 | 10 |
| 0100 01 0910 | 9x10 | 117 | 4.6 | 20 | 22 | 30 | 10 |
| 0100 01 0911 | 9x11 | 120 | 4.6 | 20 | 24 | 30 | 10 |
| 0100 01 1014 | 10x14 | 120 | 5.2 | 22 | 30 | 50 | 10 |
| 0100 01 1113 | 11x13 | 133 | 5.2 | 26 | 28 | 50 | 10 |
| 0100 01 1114 | 11x14 | 133 | 5.2 | 26 | 28 | 50 | 10 |
| 0100 01 1315 | 13x15 | 147 | 5.2 | 28 | 30 | 65 | 10 |
| 0100 01 1722 | 17x22 | 195 | 7.4 | 36 | 46 | 160 | 10 |
| 0100 01 1820 | 18x20 | 178 | 7 | 38 | 40 | 125 | 10 |
| 0100 01 1822 | 18x22 | 195 | 7.4 | 40 | 46 | 160 | 10 |
| 0100 01 1924 | 19x24 | 213 | 7.7 | 40 | 50 | 200 | 10 |
| 0100 01 2226 | 22x26 | 232 | 8 | 46 | 54 | 250 | 10 |
| 0100 01 2227 | 22x27 | 232 | 8.2 | 46 | 56 | 260 | 10 |
| 0100 01 2430 | 24x30 | 265 | 9 | 50 | 62 | 370 | 10 |
| 0100 01 2730 | 27x30 | 265 | 9 | 56 | 62 | 380 | 10 |

0100
İki Ağız Anahtar Takımı Kısa Boy (mm)
*Double Ended Open Jaw Wrench
 Short Pattern Set (mm)*

| KOD CODE | İÇERİK CONTENTS | g | TL/Ad. |
|--------------|--|------|--------|
| 0100 00 2108 | 6x7 - 8x9 - 10x11 12x13 - 14x15 - 16x17 18x19 - 20x22 | 736 | 8 |
| 0100 00 2112 | 6x7 - 8x9 - 10x11 12x13 - 14x15 - 16x17 18x19 - 20x22 - 21x23 24x26 - 25x28 - 30x32 | 2110 | 12 |

İki Ağız Anahtar Uzun Boy (mm)

Double Ended Open Jaw Wrench Long Pattern (mm)

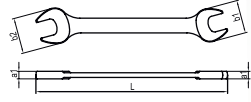

TS ISO 10102
DIN 3110

Krom vanadyum, Krom kaplı
Chrom vanadium, Chrom plated

| KOD CODE | mm | L mm | a1 mm | b1 mm | b2 mm | g | TL/ Ad. |
|--------------|-------|------|-------|-------|-------|------|---------|
| 0130 01 0607 | 6x7 | 125 | 3.5 | 14 | 16 | 24 | 10 |
| 0130 01 0608 | 6x8 | 125 | 3.5 | 14 | 18 | 20 | 10 |
| 0130 01 0809 | 8x9 | 140 | 4 | 18 | 20 | 35 | 10 |
| 0130 01 0810 | 8x10 | 140 | 4 | 18 | 22 | 36 | 10 |
| 0130 01 1011 | 10x11 | 155 | 4.5 | 22 | 24 | 47 | 10 |
| 0130 01 1012 | 10x12 | 162 | 4.7 | 22 | 26 | 57 | 10 |
| 0130 01 1013 | 10x13 | 162 | 4.7 | 22 | 28 | 61 | 10 |
| 0130 01 1014 | 10x14 | 162 | 4.7 | 22 | 28 | 65 | 10 |
| 0130 01 1113 | 11x13 | 172 | 5 | 26 | 28 | 70 | 10 |
| 0130 01 1114 | 11x14 | 172 | 5 | 26 | 30 | 65 | 10 |
| 0130 01 1213 | 12x13 | 172 | 5 | 26 | 28 | 67 | 10 |
| 0130 01 1214 | 12x14 | 172 | 5 | 26 | 30 | 65 | 10 |
| 0130 01 1314 | 13x14 | 188 | 5.5 | 28 | 30 | 85 | 10 |
| 0130 01 1315 | 13x15 | 188 | 5.5 | 30 | 32 | 93 | 10 |
| 0130 01 1415 | 14x15 | 188 | 5.5 | 30 | 32 | 91 | 10 |
| 0130 01 1317 | 13x17 | 205 | 6.2 | 28 | 36 | 111 | 10 |
| 0130 01 1417 | 14x17 | 205 | 6.2 | 30 | 36 | 106 | 10 |
| 0130 01 1617 | 16x17 | 205 | 6.2 | 34 | 36 | 120 | 10 |
| 0130 01 1618 | 16x18 | 220 | 7 | 36 | 40 | 165 | 10 |
| 0130 01 1719 | 17x19 | 220 | 7 | 36 | 40 | 160 | 10 |
| 0130 01 1819 | 18x19 | 220 | 7 | 38 | 40 | 161 | 10 |
| 0130 01 1921 | 19x21 | 235 | 7.5 | 40 | 46 | 195 | 5 |
| 0130 01 1922 | 19x22 | 235 | 7.5 | 40 | 46 | 195 | 5 |
| 0130 01 2022 | 20x22 | 235 | 7.5 | 42 | 46 | 195 | 5 |
| 0130 01 1924 | 19x24 | 248 | 8.3 | 40 | 50 | 235 | 5 |
| 0130 01 2123 | 21x23 | 248 | 8.3 | 44 | 48 | 235 | 5 |
| 0130 01 2224 | 22x24 | 248 | 8.3 | 46 | 50 | 235 | 5 |
| 0130 01 2426 | 24x26 | 265 | 8.8 | 50 | 54 | 300 | 5 |
| 0130 01 2427 | 24x27 | 265 | 8.8 | 50 | 56 | 300 | 5 |
| 0130 01 2430 | 24x30 | 282 | 9.3 | 50 | 61.5 | 380 | 5 |
| 0130 01 2528 | 25x28 | 282 | 9.3 | 52 | 57.5 | 390 | 5 |
| 0130 01 2729 | 27x29 | 300 | 9.8 | 56 | 59 | 400 | 5 |
| 0130 01 2730 | 27x30 | 300 | 9.8 | 56 | 59 | 440 | 5 |
| 0130 01 2732 | 27x32 | 300 | 9.8 | 56 | 65.5 | 460 | 5 |
| 0130 01 3032 | 30x32 | 300 | 9.8 | 61.5 | 65.5 | 480 | 5 |
| 0130 01 3036 | 30x36 | 325 | 10.4 | 61.5 | 76 | 645 | 5 |
| 0130 01 3236 | 32x36 | 325 | 10.4 | 65.5 | 76 | 680 | 5 |
| 0130 01 3436 | 34x36 | 330 | 10.4 | 71 | 76 | 690 | 5 |
| 0130 01 3641 | 36x41 | 360 | 12 | 76 | 87 | 955 | 5 |
| 0130 01 4146 | 41x46 | 400 | 12.5 | 87 | 98 | 1300 | 5 |
| 0130 01 4650 | 46x50 | 450 | 13 | 98 | 107 | 1635 | 5 |

ÖZEL SERİLER (adet ve termin süresi isteyiniz)

SPECIAL SERIES (ask for quantity and delivery terms)

| | | | | | | | |
|--------------|-------|-----|-----|----|----|-----|----|
| 0130 01 0555 | 5x5.5 | 125 | 3.5 | 14 | 16 | 15 | 10 |
| 0130 01 0708 | 7x8 | 135 | 3.5 | 16 | 18 | 20 | 10 |
| 0130 01 0709 | 7x9 | 140 | 4 | 16 | 20 | 30 | 10 |
| 0130 01 0910 | 9x10 | 140 | 4 | 18 | 22 | 45 | 10 |
| 0130 01 0911 | 9x11 | 155 | 4.5 | 22 | 24 | 45 | 10 |
| 0130 01 1722 | 17x22 | 235 | 7.5 | 36 | 46 | 190 | 5 |
| 0130 01 1724 | 17x24 | 248 | 8.3 | 36 | 50 | 240 | 5 |
| 0130 01 2227 | 22x27 | 265 | 8.8 | 46 | 56 | 300 | 5 |

0130

İki Ağız Anahtar Takımı Uzun Boy (mm)

Double Ended Open Jaw Wrench
Long Pattern Set (mm)

TS ISO 10102
DIN 3110



| KOD CODE | İÇERİK CONTENTS | g | TL/Ad. |
|--------------|--|------|--------|
| 0130 00 2108 | 6x7 - 8x9 - 10x11 - 12x13 14x15 - 16x17 - 18x19 20x22 | 815 | 8 |
| 0130 00 2112 | 6x7 - 8x9 - 10x11 12x13 - 14x15 - 16x17 18x19 - 20x22 - 21x23 24x26 - 25x28 - 27x32 | 2315 | 12 |

(★) İşletmeli olan ürünler stoklarla sınırlıdır.
Limited with stocks.

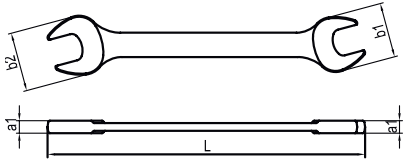
0161
İki Ağız Anahtar Uzun Boy (SAE)
Double Ended Open Jaw Wrench Long Pattern (SAE)
TSEK

Krom vanadyum, Krom kaplı
Chrom vanadium, Chrom plated

| KOD CODE | inch | L mm | a1 mm | b1 mm | b2 mm | g | TL/Ad. |
|--------------|----------------|------|-------|-------|-------|-----|--------|
| 0161 01 0608 | 1/4"x5/16" | 125 | 3.5 | 18 | 16 | 18 | 10 |
| 0161 01 0809 | 5/16"x3/8" | 140 | 4 | 18 | 20 | 30 | 10 |
| 0161 01 0810 | 5/16"x11/32" | 140 | 4 | 18 | 20 | 30 | 10 |
| 0161 01 0811 | 5/16"x7/16" | 140 | 4 | 18 | 22 | 30 | 10 |
| 0161 01 0911 | 3/8"x7/16" | 155 | 4.5 | 22 | 24 | 35 | 10 |
| 0161 01 1112 | 7/16"x1/2" | 172 | 5 | 26 | 28 | 40 | 10 |
| 0161 01 1214 | 1/2"x9/16" | 172 | 5 | 26 | 30 | 65 | 10 |
| 0161 01 1416 | 9/16"x5/8" | 188 | 5.5 | 30 | 32 | 85 | 10 |
| 0161 01 1417 | 9/16"x11/16" | 205 | 6.2 | 30 | 36 | 110 | 10 |
| 0161 01 1517 | 19/32"x11/16" | 205 | 6.2 | 34 | 36 | 115 | 10 |
| 0161 01 1619 | 5/8"x3/4" | 220 | 7 | 36 | 40 | 150 | 10 |
| 0161 01 1920 | 3/4"x25/32" | 220 | 7 | 38 | 40 | 160 | 10 |
| 0161 01 2021 | 25/32"x13/16" | 235 | 7.5 | 40 | 46 | 195 | 10 |
| 0161 01 1922 | 3/4"x7/8" | 235 | 7.5 | 40 | 46 | 195 | 10 |
| 0161 01 2122 | 13/16"x7/8" | 248 | 8.3 | 44 | 48 | 235 | 10 |
| 0161 01 2325 | 15/16"x1" | 265 | 8.8 | 50 | 54 | 300 | 10 |
| 0161 01 2328 | 15/16"x1 1/8" | 265 | 8.8 | 50 | 56 | 300 | 10 |
| 0161 01 2628 | 1 1/16"x1 1/8" | 300 | 9.8 | 56 | 59.5 | 460 | 10 |
| 0161 01 2631 | 1 1/16"x1 1/4" | 300 | 9.8 | 56 | 65.5 | 460 | 10 |
| 0161 01 2833 | 1 1/8"x1 5/16" | 300 | 9.8 | 56 | 65.5 | 460 | 10 |

0161
İki Ağız Anahtar Takımı Uzun Boy (SAE)
Double Ended Open Jaw Wrench Long Pattern Set (SAE)
TSEK

| KOD CODE | İÇERİK CONTENTS | g | TL/Ad. |
|--------------|---|------|--------|
| 0161 00 2108 | 1/4"x5/16" - 5/16"x3/8" 7/16"x1/2" - 9/16"x5/8" - 19/32"x11/16" 3/4"x25/32" - 13/16"x7/8" - 15/16"x1" | 1090 | 8 |
| 0161 00 2112 | 1/4"x5/16" - 5/16"x3/8" - 3/8"x7/16" 7/16"x1/2" - 1/2"x9/16" - 9/16"x5/8" 19/32"x11/16" - 3/4"x25/32" - 13/16"x7/8" 15/16"x1" - 1 1/16"x1 1/4" 1 1/8"x1 5/16" | 2165 | 12 |

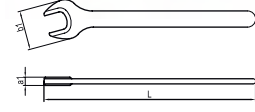
Bir Ağız Taçlı Anahtar (mm)
Single Ended Open Jaw Wrench (mm)

Krom vanadyum
Chrom vanadium

| KOD CODE | mm | L mm | a1 mm | b1 mm | g | TL/Ad. |
|--------------|----|------|-------|-------|------|--------|
| 0250 01 0030 | 30 | 260 | 10.5 | 60 | 250 | 1 |
| 0250 01 0036 | 36 | 300 | 10.5 | 74.5 | 370 | 1 |
| 0250 01 0041 | 41 | 345 | 12.2 | 85.5 | 550 | 1 |
| 0250 01 0046 | 46 | 390 | 14 | 96.5 | 750 | 1 |
| 0250 01 0050 | 50 | 423 | 15.2 | 105 | 1000 | 1 |
| 0250 01 0055 | 55 | 455 | 16.5 | 113.5 | 1300 | 1 |
| 0250 01 0060 | 60 | 490 | 17.6 | 121 | 1600 | 1 |
| 0250 01 0065 | 65 | 524 | 19 | 130 | 1980 | 1 |

ÖZEL SERİLER (adet ve termin süresi isteyiniz)
SPECIAL SERIES (ask for quantity and delivery terms)

| | | | | | | |
|--------------|----|-----|------|------|------|---|
| 0250 01 0021 | 21 | 185 | 8 | 42.4 | 95 | 1 |
| 0250 01 0022 | 22 | 195 | 8 | 44.4 | 110 | 1 |
| 0250 01 0023 | 23 | 195 | 8 | 46.3 | 115 | 1 |
| 0250 01 0024 | 24 | 215 | 9 | 48.3 | 150 | 1 |
| 0250 01 0025 | 25 | 215 | 9 | 50.3 | 155 | 1 |
| 0250 01 0027 | 27 | 240 | 9.5 | 54.3 | 200 | 1 |
| 0250 01 0032 | 32 | 274 | 11 | 63 | 300 | 1 |
| 0250 01 0034 | 34 | 274 | 11 | 68 | 320 | 1 |
| 0250 01 0038 | 38 | 300 | 10.5 | 76.8 | 400 | 1 |
| 0250 01 0070 | 70 | 564 | 20.8 | 140 | 2480 | 1 |
| 0250 01 0075 | 75 | 608 | 21.8 | 151 | 3100 | 1 |

Süper İzole Çatal Bir Ağız Anahtar (mm)
Single Ended Open Jaw Wrench Super Insulated (mm)

 IEC 60900
 ⚡ 1000 V

Krom vanadyum, Krom kaplı, Kalın PVC izoleli
Chrom vanadium, Chrom plated, Triple PVC insulated

| KOD CODE | mm | L mm | g | TL/Ad. |
|--------------|----|------|-----|--------|
| 0255 01 0010 | 10 | 110 | 40 | 10 |
| 0255 01 0011 | 11 | 120 | 45 | 10 |
| 0255 01 0012 | 12 | 130 | 50 | 10 |
| 0255 01 0013 | 13 | 140 | 60 | 10 |
| 0255 01 0014 | 14 | 155 | 75 | 10 |
| 0255 01 0017 | 17 | 170 | 100 | 10 |
| 0255 01 0019 | 19 | 185 | 150 | 10 |
| 0255 01 0022 | 22 | 200 | 200 | 10 |
| 0255 01 0024 | 24 | 220 | 280 | 10 |

Montaj Anahtar (mm)
Speed Wrench (mm)

İZELTAS YOUTUBE

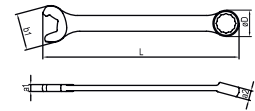
Krom vanadyum, Krom kaplı
Chrom vanadium, Chrom plated

| KOD CODE | mm | L mm | a1 mm | a2 mm | b1 mm | ØD mm | g | TL/Ad. |
|--------------|----|------|-------|-------|-------|-------|-----|--------|
| 0325 02 0010 | 10 | 135 | 4.3 | 6.9 | 22 | 15.5 | 35 | 10 |
| 0325 02 0013 | 13 | 165 | 5.2 | 7.9 | 28 | 19.5 | 45 | 10 |
| 0325 02 0017 | 17 | 205 | 6.4 | 9.8 | 36 | 25.5 | 110 | 10 |
| 0325 02 0019 | 19 | 225 | 7 | 11 | 40 | 28.5 | 155 | 10 |
| 0325 02 0020 | 20 | 230 | 7.2 | 11.4 | 42 | 30 | 180 | 10 |
| 0325 02 0021 | 21 | 242 | 7.4 | 12 | 44 | 31.5 | 180 | 10 |
| 0325 02 0022 | 22 | 250 | 8.2 | 12.6 | 46 | 33 | 245 | 10 |

%100 Daha Hızlı

Yeni tasarlanan montaj anahtarları, 2 kat hızını cırcır mekanizması mantığına dayanan çalışma prensibinden alır. Kullanım sırasında, montaj anahtarını civatadan ayırmadan döndürme kolaylığı kullanım hızını arttırırken, civata köşelerine sağlam tutunan anahtar profili güvenli ve kaydırmaz kullanım sağlar.

Uzun Ömür

Bu yeni montaj anahtarları profili, civata ve somunlar ile köşelerinden değil düz yüzeyleri üzerinden temas ederek düzenli tork iletimini sağlarken, gerilimin artmasını da engelleyerek anahtar ömrünün uzamasını sağlar.

• Anahtarları civatadan ayırmadan hızlı kullanılır.

• Güvenli tork iletimi ve uzun ömür.

100% Faster

The 100% new design speed wrench takes the 2-fold speed from the operating principle based on the ratchet mechanism logic. While in use, the ease of rotation without detaching the mounting wrench from the bolt increases the speed of use and the profile that firmly secured to the corners ensures safe and non-slip use

Long Life

This new mounting wrench profile by contacting bolts and nuts, not on corners, but on their flat surfaces, allows regular torx transmission, prevents the increase in surface tension and provides longer life.

• Quick use without detaching the wrench from the bolt.

• Safe torx transmission and long life.

Kombine Anahtar Kısa Boy (mm)
Combination Wrench Short Pattern (mm)

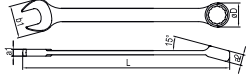
 TS 3794
 TS ISO 7738 Form A
 DIN 3113

 Krom vanadyum, Krom kaplı
 Chrom vanadium, Chrom plated

| KOD CODE | mm | L mm | a1 mm | a2 mm | b1 mm | øD mm | g | TL/Ad. |
|--------------|-----|------|-------|-------|-------|-------|-----|--------|
| 0320 02 0005 | 5 | 90 | 3.4 | 5.1 | 14 | 10 | 15 | 10 |
| 0320 02 0055 | 5.5 | 90 | 3.4 | 5.1 | 14 | 10 | 15 | 10 |
| 0320 02 0006 | 6 | 100 | 3.4 | 5.1 | 14 | 10 | 15 | 10 |
| 0320 02 0007 | 7 | 110 | 3.6 | 5.5 | 16 | 11 | 20 | 10 |
| 0320 02 0008 | 8 | 120 | 3.8 | 5.9 | 18 | 13 | 25 | 10 |
| 0320 02 0009 | 9 | 130 | 4 | 6.3 | 20 | 14 | 30 | 10 |
| 0320 02 0010 | 10 | 140 | 4.3 | 6.9 | 22 | 15.5 | 40 | 10 |
| 0320 02 0011 | 11 | 150 | 4.5 | 7.3 | 24 | 17 | 45 | 10 |
| 0320 02 0012 | 12 | 160 | 4.9 | 7.7 | 26 | 18.5 | 55 | 10 |
| 0320 02 0013 | 13 | 170 | 5.2 | 7.9 | 28 | 19.5 | 60 | 10 |
| 0320 02 0014 | 14 | 180 | 5.5 | 8.7 | 30 | 21.5 | 75 | 10 |
| 0320 02 0015 | 15 | 190 | 5.8 | 9.1 | 32 | 22.5 | 90 | 10 |
| 0320 02 0016 | 16 | 200 | 6.1 | 9.6 | 34 | 24 | 105 | 10 |
| 0320 02 0017 | 17 | 210 | 6.4 | 9.8 | 36 | 25.5 | 120 | 10 |
| 0320 02 0018 | 18 | 220 | 6.8 | 10.4 | 38 | 27 | 145 | 10 |
| 0320 02 0019 | 19 | 232 | 7 | 11 | 40 | 28.5 | 170 | 10 |
| 0320 02 0020 | 20 | 240 | 7.2 | 11.4 | 42 | 30 | 195 | 10 |
| 0320 02 0021 | 21 | 250 | 7.4 | 12 | 44 | 31.5 | 190 | 10 |
| 0320 02 0022 | 22 | 260 | 8.2 | 12.6 | 46 | 33 | 275 | 10 |
| 0320 02 0023 | 23 | 270 | 8.3 | 13 | 48 | 35 | 255 | 5 |
| 0320 02 0024 | 24 | 280 | 8.5 | 13.6 | 50 | 36.5 | 320 | 5 |
| 0320 02 0025 | 25 | 290 | 8.8 | 14 | 52 | 39 | 320 | 5 |
| 0320 02 0026 | 26 | 300 | 9 | 14.8 | 54 | 41 | 400 | 5 |
| 0320 02 0027 | 27 | 310 | 9.3 | 15 | 56 | 41.5 | 400 | 5 |
| 0320 02 0028 | 28 | 320 | 9.4 | 15.4 | 57.5 | 42.5 | 380 | 5 |
| 0320 02 0029 | 29 | 330 | 10 | 15.6 | 59 | 43.5 | 510 | 5 |
| 0320 02 0030 | 30 | 340 | 10.3 | 16 | 61.5 | 44 | 505 | 5 |
| 0320 02 0032 | 32 | 370 | 10.5 | 16.2 | 65.5 | 47 | 560 | 5 |
| 0320 02 0034 | 34 | 400 | 10.7 | 16.8 | 71 | 50 | 675 | 5 |

0320
Kombine Anahtar Takımı Kısa Boy (mm)
Combination Wrench Short Pattern Set (mm)

| KOD CODE | İÇERİK CONTENTS | g | TL/Ad. |
|--------------|--|------|--------|
| 0320 00 2108 | 6 - 7 - 8 - 9 - 10 - 13 - 17 - 19 | 475 | 8 |
| 0320 00 2112 | 8 - 9 - 10 - 11 - 12 - 13 - 14 15 - 16 - 17 - 19 - 22 | 1190 | 12 |
| 0320 00 2117 | 6 - 7 - 8 - 9 - 10 - 11 - 12 - 13 - 14 15 - 16 - 17 - 18 - 19 - 20 - 21 - 22 | 1760 | 17 |
| 0320 00 2121 | 6 - 7 - 8 - 9 - 10 - 11 - 12 - 13 - 14 15 - 16 - 17 - 18 - 19 - 20 - 21 - 22 24 - 27 - 30 - 32 | 3650 | 21 |

 (★) İşaretili olan ürünler stoklarla sınırlıdır.
 Limited with stocks.

Kombine Anahtar Uzun Boy (mm)
Combination Wrench, Long Pattern (mm)

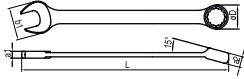
 TS 3794
 TS ISO 7738 Form A
 DIN 3113

 Krom vanadyum, Krom kaplı
Chrom vanadium, Chrom plated

| KOD CODE | mm | L mm | a1 mm | a2 mm | b1 mm | øD mm | g | TL/Ad. |
|--------------|-----|------|-------|-------|-------|-------|------|--------|
| 0330 02 0005 | 5 | 95 | 3.2 | 5.2 | 12.5 | 9 | 20 | 10 |
| 0330 02 0055 | 5.5 | 95 | 3.2 | 5.2 | 12.5 | 9 | 20 | 10 |
| 0330 02 0006 | 6 | 105 | 3.8 | 5.6 | 14 | 10.5 | 20 | 10 |
| 0330 02 0007 | 7 | 117 | 4 | 6.1 | 16 | 12 | 20 | 10 |
| 0330 02 0008 | 8 | 130 | 4.2 | 6.6 | 18 | 13.5 | 30 | 10 |
| 0330 02 0009 | 9 | 141 | 4.5 | 7 | 20 | 15 | 40 | 10 |
| 0330 02 0010 | 10 | 154 | 4.7 | 7.6 | 22 | 16 | 50 | 10 |
| 0330 02 0011 | 11 | 166 | 5 | 8.2 | 24 | 17.5 | 60 | 10 |
| 0330 02 0012 | 12 | 178 | 5.2 | 8.7 | 26 | 19 | 70 | 10 |
| 0330 02 0013 | 13 | 190 | 5.6 | 9.2 | 28 | 20.5 | 80 | 10 |
| 0330 02 0014 | 14 | 203 | 5.8 | 9.7 | 30 | 22 | 100 | 10 |
| 0330 02 0015 | 15 | 215 | 6.4 | 10.1 | 32 | 23.5 | 115 | 10 |
| 0330 02 0016 | 16 | 227 | 6.4 | 10.8 | 34 | 25 | 135 | 10 |
| 0330 02 0017 | 17 | 239 | 6.6 | 11.4 | 36 | 26.5 | 160 | 10 |
| 0330 02 0018 | 18 | 250 | 7 | 12 | 38 | 28 | 186 | 10 |
| 0330 02 0019 | 19 | 263 | 7.3 | 12.7 | 40 | 29.5 | 205 | 10 |
| 0330 02 0020 | 20 | 275 | 7.7 | 13.2 | 42 | 31 | 235 | 10 |
| 0330 02 0021 | 21 | 288 | 8.1 | 13.3 | 44 | 31.5 | 260 | 10 |
| 0330 02 0022 | 22 | 300 | 8.5 | 13.7 | 46 | 34 | 300 | 10 |
| 0330 02 0023 | 23 | 315 | 8.8 | 14.2 | 48 | 35.5 | 300 | 5 |
| 0330 02 0024 | 24 | 330 | 9 | 14.2 | 50 | 37 | 390 | 5 |
| 0330 02 0025 | 25 | 340 | 9.3 | 14.7 | 52 | 38.5 | 380 | 5 |
| 0330 02 0026 | 26 | 350 | 9.7 | 14.7 | 54 | 40 | 475 | 5 |
| 0330 02 0027 | 27 | 360 | 10 | 15.2 | 56 | 41 | 475 | 5 |
| 0330 02 0028 | 28 | 370 | 10.4 | 15.7 | 57.5 | 43 | 475 | 5 |
| 0330 02 0029 | 29 | 390 | 10.8 | 16.2 | 59 | 44 | 610 | 5 |
| 0330 02 0030 | 30 | 410 | 11.2 | 16.6 | 61.5 | 45 | 610 | 5 |
| 0330 02 0032 | 32 | 420 | 11.5 | 17.1 | 65.5 | 48 | 755 | 5 |
| 0330 02 0034 | 34 | 430 | 11.8 | 17.4 | 71 | 50.5 | 735 | 5 |
| 0330 02 0036 | 36 | 440 | 12.2 | 17.7 | 76 | 53 | 1000 | 5 |
| 0330 02 0038 | 38 | 450 | 12.5 | 18.7 | 80 | 56 | 1000 | 5 |
| 0330 02 0041 | 41 | 480 | 13.5 | 19.7 | 87 | 61 | 1240 | 5 |
| 0330 02 0046 | 46 | 505 | 14.7 | 20.7 | 95 | 67.5 | 1635 | 1 |
| 0330 02 0050 | 50 | 540 | 15.9 | 22.7 | 104 | 73.5 | 2100 | 1 |

0330
Kombine Anahtar Takımı Uzun Boy (mm)
Combination Wrench Long Pattern Set (mm)

| KOD CODE | İÇERİK CONTENTS | g | TL/Ad. |
|--------------|---|------|--------|
| 0330 00 2108 | 6 - 7 - 8 - 9 - 10 - 13 17 - 19 | 665 | 8 |
| 0330 00 2112 | 8 - 9 - 10 - 11 - 12 13 - 14 - 15 - 16 17 - 19 - 22 | 1780 | 12 |
| 0330 00 2117 | 6 - 7 - 8 - 9 - 10 11 - 12 - 13 - 14 - 15 16 - 17 - 18 - 19 20 - 21 - 22 | 2170 | 17 |
| 0330 00 2121 | 6 - 7 - 8 - 9 - 10 - 11 12 - 13 - 14 - 15 - 16 17 - 18 - 19 - 20 - 21 22 - 24 - 27 - 30 - 32 | 4465 | 21 |

Kombine Anahtar Uzun Boy (SAE)
Combination Wrench Long Pattern (SAE)
TSEK

WRENCHES

ANAHTARLAR

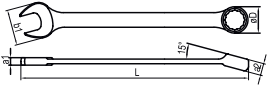
 Krom vanadyum, Krom kaplı
 Chrom vanadium, Chrom plated

| KOD CODE | inch | L mm | a1 mm | a2 mm | b1 mm | øD mm | g | TL/Ad. |
|--------------|---------|------|-------|-------|-------|-------|------|--------|
| 0331 02 0005 | 3/16" | 95 | 3.2 | 5.2 | 12.5 | 9 | 15 | 10 |
| 0331 02 0006 | 1/4" | 105 | 3.8 | 5.6 | 14 | 10.5 | 20 | 10 |
| 0331 02 0008 | 5/16" | 130 | 4.2 | 6.6 | 18 | 13.5 | 30 | 10 |
| 0331 02 0010 | 3/8" | 154 | 4.7 | 7.6 | 22 | 16 | 50 | 10 |
| 0331 02 0011 | 7/16" | 166 | 5 | 8.2 | 24 | 17.5 | 60 | 10 |
| 0331 02 0013 | 1/2" | 190 | 5.6 | 9.2 | 28 | 20.5 | 80 | 10 |
| 0331 02 0014 | 9/16" | 203 | 5.8 | 9.7 | 30 | 22 | 100 | 10 |
| 0331 02 0015 | 19/32" | 215 | 6.4 | 10.1 | 32 | 23.5 | 115 | 10 |
| 0331 02 0016 | 5/8" | 227 | 6.4 | 10.8 | 34 | 25 | 135 | 10 |
| 0331 02 0017 | 11/16" | 239 | 6.6 | 11.4 | 36 | 26.5 | 155 | 10 |
| 0331 02 0019 | 3/4" | 263 | 7.3 | 12.7 | 40 | 29.5 | 205 | 10 |
| 0331 02 0020 | 25/32" | 275 | 7.7 | 13.2 | 42 | 31 | 230 | 10 |
| 0331 02 0021 | 13/16" | 288 | 8.1 | 13.3 | 44 | 31.5 | 260 | 5 |
| 0331 02 0022 | 7/8" | 300 | 8.5 | 13.7 | 46 | 34 | 310 | 5 |
| 0331 02 0024 | 15/16" | 330 | 9 | 14.2 | 50 | 37 | 380 | 5 |
| 0331 02 0025 | 1" | 340 | 9.3 | 14.7 | 52 | 38.5 | 380 | 5 |
| 0331 02 0027 | 1 1/16" | 360 | 10 | 15.2 | 56 | 41 | 470 | 5 |
| 0331 02 0028 | 1 1/8" | 370 | 10.4 | 15.7 | 57.5 | 43 | 470 | 5 |
| 0331 02 0030 | 1 3/16" | 410 | 11.2 | 16.6 | 61.5 | 45 | 635 | 5 |
| 0331 02 0032 | 1 1/4" | 420 | 11.5 | 17.1 | 65.5 | 48 | 775 | 5 |
| 0331 02 0033 | 1 5/16" | 430 | 11.8 | 17.4 | 71 | 50.5 | 775 | 5 |
| 0331 02 0038 | 1 1/2" | 450 | 12.5 | 18.7 | 80 | 56 | 1015 | 5 |

ÖZEL SERİLER (adet ve termin süresi isteyiniz)
SPECIAL SERIES (ask for quantity and delivery terms)

| | | | | | | | | |
|--------------|----------|-----|------|------|-----|------|------|---|
| 0331 02 0035 | 1 3/8" | 440 | 12.2 | 17.7 | 76 | 53 | 1015 | 5 |
| 0331 02 0036 | 1 7/16" | 440 | 12.2 | 17.7 | 76 | 53 | 1015 | 5 |
| 0331 02 0041 | 1 5/8" | 480 | 13.5 | 19.7 | 87 | 61 | 1325 | 5 |
| 0331 02 0046 | 1 13/16" | 505 | 14.7 | 20.7 | 95 | 67.5 | 1750 | 5 |
| 0331 02 0050 | 2" | 540 | 15.9 | 22.7 | 104 | 73.5 | 2200 | 5 |

0331
Kombine Anahtar Takımı Uzun Boy (SAE)
Combination Wrench Long Pattern Set (SAE)

| KOD CODE | İÇERİK CONTENTS | g | TL/Ad. |
|--------------|---|------|--------|
| 0331 00 2108 | 5/16" - 3/8" - 7/16" - 1/2" - 9/16" - 5/8" - 11/16" - 3/4" | 925 | 8 |
| 0331 00 2112 | 5/16" - 3/8" - 7/16" - 1/2" - 9/16" - 5/8" - 11/16" - 3/4" - 13/16" - 7/8" - 15/16" - 1" | 2320 | 12 |
| 0331 00 2117 | 1/4" - 5/16" - 3/8" - 7/16" - 1/2" - 9/16" - 19/32" - 5/8" - 11/16" - 3/4" - 25/32" - 13/16" - 7/8" - 15/16" - 1" - 1 1/16" - 1 3/16" | 3875 | 17 |
| 0331 00 2120 | 1/4" - 5/16" - 3/8" - 7/16" - 1/2" - 9/16" - 19/32" - 5/8" - 11/16" - 3/4" - 25/32" - 13/16" - 7/8" - 15/16" - 1" - 1 1/16" - 1 1/8" - 1 3/16" - 1 1/4" - 1 5/16" | 5880 | 20 |

 (★) İşaretili olan ürünler stoklarla sınırlıdır.
 Limited with stocks.

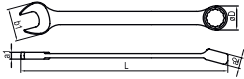
Çırcır Kombine Anahtar (mm)
Combination Wrench With Ratchet (mm)

Krom vanadyum, Krom kaplı
Chrom vanadium, Chrom plated

| KOD CODE | mm | L mm | a1 mm | a2 mm | b1 mm | øD mm | g | TL/Ad. |
|--------------|----|------|-------|-------|-------|-------|-----|--------|
| 0340 02 0008 | 8 | 140 | 4.9 | 6.4 | 16.9 | 17.1 | 35 | 10 |
| 0340 02 0009 | 9 | 149 | 5 | 6.7 | 19.7 | 19.1 | 40 | 10 |
| 0340 02 0010 | 10 | 159 | 5 | 7 | 21.1 | 20.3 | 55 | 10 |
| 0340 02 0011 | 11 | 165 | 5.3 | 7.3 | 24 | 22.5 | 70 | 10 |
| 0340 02 0012 | 12 | 171 | 5.6 | 7.6 | 26.5 | 23.5 | 80 | 10 |
| 0340 02 0013 | 13 | 178 | 5.9 | 8.1 | 27.7 | 25.3 | 90 | 10 |
| 0340 02 0014 | 14 | 190 | 6.3 | 8.5 | 30.7 | 27.5 | 120 | 10 |
| 0340 02 0015 | 15 | 199 | 6.7 | 9 | 32 | 28.8 | 135 | 10 |
| 0340 02 0016 | 16 | 208 | 6.7 | 9.5 | 34 | 30.3 | 155 | 10 |
| 0340 02 0017 | 17 | 225 | 7 | 10 | 36.2 | 32.2 | 190 | 10 |
| 0340 02 0018 | 18 | 236 | 7.7 | 10.5 | 38.2 | 33.3 | 200 | 10 |
| 0340 02 0019 | 19 | 248 | 8.3 | 11 | 40.4 | 35 | 240 | 10 |
| 0340 02 0021 | 21 | 288 | 9.4 | 13 | 45.7 | 40.7 | 350 | 10 |
| 0340 02 0022 | 22 | 288 | 9.4 | 13 | 45.7 | 40.7 | 340 | 10 |
| 0340 02 0024 | 24 | 321 | 10.5 | 14.5 | 52 | 46.2 | 470 | 5 |

0340
Çırcır Kombine Anahtar Takımı (mm)
Combination Wrench With Ratchet, Set (mm)

0335
Çoklu Yıldız Çırcır Anahtar (mm)
Multi-Ring Wrench (mm)

Krom vanadyum, Krom kaplı
Chrom vanadium, Chrom plated

| KOD CODE | ÖLÇÜ SIZE | L mm | g | TL/Ad. |
|--------------|-------------|------|-----|--------|
| 0335 02 0010 | 10x13x17x19 | 230 | 215 | 5 |

| KOD CODE | İÇERİK CONTENTS | g | TL/Ad. |
|--------------|--|------|--------|
| 0340 00 2110 | 8 - 9 - 10 - 11 12 - 13 - 14 - 15 17 - 19 | 1315 | 10 |
| 0340 00 2115 | 8 - 9 - 10 - 11 - 12 - 13 14 - 15 - 16 - 17 - 18 19 - 21 - 22 - 24 | 2445 | 15 |

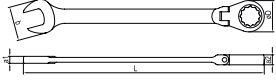
0345
Mafsallı Cırcır Kombine Anahtar (mm)
Flexible Head Combination Wrench With Ratchet (mm)

Krom vanadyum, Krom kaplı
Chrom vanadium, Chrom plated

| KOD CODE | mm | L mm | a1 mm | a2 mm | b mm | øD mm | g | | TL/Ad. |
|--------------|----|---------|----------|----------|---------|----------|-----|----|--------|
| 0345 02 0008 | 8 | 136 | 5.5 | 7 | 17 | 17.5 | 40 | 10 | |
| 0345 02 0009 | 9 | 140 | 6.1 | 7.7 | 21.5 | 21 | 50 | 10 | |
| 0345 02 0010 | 10 | 140 | 6.1 | 7.7 | 21.5 | 21 | 60 | 10 | |
| 0345 02 0011 | 11 | 142 | 6.4 | 8.3 | 23.5 | 22.5 | 80 | 10 | |
| 0345 02 0012 | 12 | 143 | 6.7 | 8.7 | 26 | 24 | 90 | 10 | |
| 0345 02 0013 | 13 | 156 | 7 | 9.3 | 27 | 26 | 105 | 10 | |
| 0345 02 0014 | 14 | 164 | 7.3 | 9.4 | 30.5 | 27.5 | 125 | 10 | |
| 0345 02 0015 | 15 | 174 | 7.7 | 10 | 32 | 29 | 145 | 10 | |
| 0345 02 0016 | 16 | 176 | 8 | 10.6 | 34 | 30.5 | 185 | 10 | |
| 0345 02 0017 | 17 | 195 | 8.3 | 10.9 | 37 | 32.5 | 210 | 10 | |
| 0345 02 0018 | 18 | 213 | 8.6 | 11.2 | 38.5 | 33.5 | 235 | 10 | |
| 0345 02 0019 | 19 | 214 | 9 | 11.5 | 40 | 35 | 260 | 10 | |

0345
Mafsallı Cırcır Kombine Anahtar Takımı (mm)
Flexible Head Combination Wrench With Ratchet, Set (mm)



| KOD CODE | İÇERİK CONTENTS | g | | TL/Ad. |
|--------------|--|------|----|--------|
| 0345 00 2112 | 8 - 9 - 10 - 11 - 12 - 13 14 - 15 - 16 - 17 - 18 - 19 | 1365 | 12 | |

(*) İşaretili olan ürünler stoklarla sınırlıdır.
Limited with stocks.

Boyunlu Kombine Anahtar (mm)
Offset Combination Wrench (mm)

 TS 3794
 TS ISO 7738 Form B
 DIN 3113

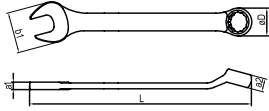
 Krom vanadyum, Krom kaplı
 Chrom vanadium, Chrom plated

0370
Boyunlu Kombine Anahtar Takımı (mm)
Offset Combination Wrench, Set (mm)

| KOD CODE | mm | L mm | a1 mm | a2 mm | b1 mm | øD mm | g | TL/Ad. |
|--------------|----|------|-------|-------|-------|-------|------|--------|
| 0370 02 0006 | 6 | 110 | 3.8 | 5.6 | 16 | 10.5 | 20 | 10 |
| 0370 02 0007 | 7 | 120 | 4 | 6.2 | 18 | 12 | 25 | 10 |
| 0370 02 0008 | 8 | 130 | 4.2 | 6.7 | 20 | 13 | 30 | 10 |
| 0370 02 0009 | 9 | 140 | 4.4 | 7.3 | 22 | 14.5 | 35 | 10 |
| 0370 02 0010 | 10 | 150 | 4.6 | 7.8 | 24 | 16 | 40 | 10 |
| 0370 02 0011 | 11 | 160 | 4.8 | 8.4 | 26 | 17 | 50 | 10 |
| 0370 02 0012 | 12 | 167 | 5 | 9 | 28 | 18.5 | 65 | 10 |
| 0370 02 0013 | 13 | 175 | 5.4 | 9.6 | 30 | 20 | 75 | 10 |
| 0370 02 0014 | 14 | 185 | 5.8 | 10.2 | 32 | 21.5 | 90 | 10 |
| 0370 02 0015 | 15 | 195 | 6.2 | 10.8 | 34 | 23 | 105 | 10 |
| 0370 02 0016 | 16 | 210 | 6.6 | 11.4 | 36 | 24.5 | 120 | 10 |
| 0370 02 0017 | 17 | 225 | 7 | 12 | 38 | 26 | 160 | 10 |
| 0370 02 0018 | 18 | 237 | 7.4 | 12.4 | 40 | 27.5 | 170 | 10 |
| 0370 02 0019 | 19 | 250 | 7.8 | 13 | 42 | 29 | 200 | 10 |
| 0370 02 0020 | 20 | 267 | 8.2 | 13.2 | 44 | 30.5 | 230 | 10 |
| 0370 02 0021 | 21 | 283 | 8.6 | 13.8 | 46 | 32 | 265 | 10 |
| 0370 02 0022 | 22 | 295 | 9.1 | 14.6 | 48 | 34.5 | 300 | 10 |
| 0370 02 0023 | 23 | 295 | 9.1 | 14.6 | 48 | 34.5 | 300 | 5 |
| 0370 02 0024 | 24 | 329 | 9.4 | 15.4 | 52 | 37 | 380 | 5 |
| 0370 02 0025 | 25 | 329 | 9.4 | 15.4 | 52 | 37 | 380 | 5 |
| 0370 02 0026 | 26 | 360 | 10.2 | 16.8 | 58 | 41 | 485 | 5 |
| 0370 02 0027 | 27 | 360 | 10.2 | 16.8 | 58 | 41 | 475 | 5 |
| 0370 02 0028 | 28 | 360 | 10.2 | 16.8 | 58 | 41 | 470 | 5 |
| 0370 02 0029 | 29 | 394 | 11 | 18.2 | 64 | 44.5 | 610 | 5 |
| 0370 02 0030 | 30 | 394 | 11 | 18.2 | 64 | 44.5 | 620 | 5 |
| 0370 02 0032 | 32 | 435 | 11.8 | 19.7 | 66 | 47.5 | 765 | 5 |
| 0370 02 0036 | 36 | 468 | 12.6 | 21.2 | 76 | 53 | 1020 | 5 |



| KOD CODE | İÇERİK CONTENTS | g | TL/Ad. |
|--------------|--|------|--------|
| 0370 00 2108 | 6 - 7 - 8 - 9 - 10 - 13 - 17 - 19 | 665 | 8 |
| 0370 00 2112 | 8 - 9 - 10 - 11 - 12 - 13 - 14 15 - 16 - 17 - 19 - 22 | 1375 | 12 |
| 0370 00 2117 | 6 - 7 - 8 - 9 - 10 - 11 - 12 - 13 - 14 15 - 16 - 17 - 18 - 19 - 20 - 21 - 22 | 2100 | 17 |
| 0370 00 2121 | 6 - 7 - 8 - 9 - 10 - 11 - 12 - 13 - 14 - 15 16 - 17 - 18 - 19 - 20 - 21 - 22 - 24 - 27 30 - 32 | 4425 | 21 |

0380

Torx® - mm Kombine Anahtar
Torx® - mm Combination Wrench



WRENCHES

ANAHTARLAR

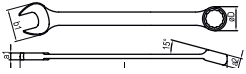

Krom vanadyum, Krom kaplı
Chrom vanadium, Chrom plated

| KOD CODE | mm | * | L mm | a1 mm | a2 mm | b1 mm | ØD mm | g | TL/ Ad. |
|--------------|----|-----|------|-------|-------|-------|-------|-----|---------|
| 0380 02 0008 | 8 | E10 | 170 | 4.5 | 7.5 | 20.5 | 13 | 45 | 10 |
| 0380 02 0009 | 9 | E12 | 180 | 4.5 | 8 | 22.5 | 14.5 | 45 | 10 |
| 0380 02 0010 | 10 | E14 | 190 | 5 | 8.5 | 24.5 | 16 | 60 | 10 |
| 0380 02 0011 | 11 | E14 | 200 | 5.5 | 9 | 26.5 | 17 | 75 | 10 |
| 0380 02 0012 | 12 | E16 | 210 | 6 | 9.5 | 28.5 | 19 | 90 | 10 |
| 0380 02 0013 | 13 | E18 | 225 | 6.5 | 10 | 30.5 | 20 | 110 | 10 |
| 0380 02 0014 | 14 | E18 | 235 | 7 | 11 | 32.5 | 22 | 120 | 10 |
| 0380 02 0015 | 15 | E20 | 250 | 7.5 | 12 | 34.5 | 23 | 150 | 10 |
| 0380 02 0017 | 17 | E22 | 280 | 8.5 | 14 | 38.5 | 26.5 | 210 | 10 |
| 0380 02 0018 | 18 | E24 | 295 | 9 | 15 | 40.5 | 28 | 240 | 10 |
| 0380 02 0019 | 19 | E24 | 310 | 9.5 | 16 | 42.5 | 29.5 | 280 | 10 |
| 0380 02 0022 | 22 | E26 | 350 | 11 | 18 | 48.5 | 34.5 | 410 | 10 |

0380

Torx® - mm Kombine Anahtar Takımı
Torx® - mm Combination Wrench Set



Torx® - mm Kombine Anahtar: Bir çatal ağız ve bir yıldız ağızdan oluşan anahtarlarımız 8-22 mm arasında boyları bulunmaktadır. Çatal ağız kısmı mevcut çatal anahtarlardan farklı olarak 6 köşe avatanın yanısıra farklı geometri lere sahip avataları açabilmekte ve sıkabilmektedir.

TORX-mm combination wrench: Our wrenches consisting of an open end and a ring end are available in sizes from 8 to 22 mm. Unlike the existing open end wrenches, its open end can unbolt and tighten bolts with different geometries as well as the

| KOD CODE | İÇERİK CONTENTS | g | TL/ Ad. |
|--------------|--|------|---------|
| | 8 - 9 - 10 - 11 - 12 - 13 - 17 - 19 | | |
| 0380 00 2108 | E10 - E12 - E14 - E14 E16 - E18 - E22 - E24 | 790 | 8 |
| | 8 - 9 - 10 - 11 - 12 - 13 14 - 15 - 17 - 18 - 19 - 22 | | |
| 0380 00 2112 | E10 - E12 - E14 - E14 - E16 - E18 E18 - E20 - E22 - E24 - E24 - E26 | 1590 | 12 |

(★) İşaretili olan ürünler stoklarla sınırlıdır.
Limited with stocks.

Yıldız İki Ağız Anahtar (mm)
Double Ended Ring Wrench (mm)

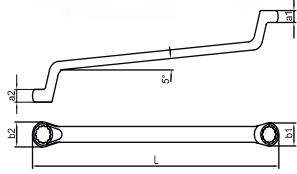
 TS 3794
 TS ISO 10104 Form B
 DIN 838

Krom vanadyum, Krom kaplı
Chrom vanadium, Chrom plated

| KOD CODE | mm | L mm | a1 mm | a2 mm | b1 mm | b2 mm | g | TL/Ad. |
|--------------|-------|------|-------|-------|-------|-------|------|--------|
| 0430 03 0607 | 6x7 | 176 | 5.6 | 6 | 10 | 11.5 | 55 | 10 |
| 0430 03 0809 | 8x9 | 190 | 6.4 | 6.8 | 13 | 14.5 | 75 | 10 |
| 0430 03 0810 | 8x10 | 190 | 6.4 | 7.3 | 13 | 15.5 | 70 | 10 |
| 0430 03 1011 | 10x11 | 206 | 7.3 | 7.6 | 15.5 | 17 | 105 | 10 |
| 0430 03 1012 | 10x12 | 206 | 7.3 | 8.5 | 15.5 | 18.5 | 105 | 10 |
| 0430 03 1013 | 10x13 | 220 | 7.3 | 9 | 15.5 | 20 | 120 | 10 |
| 0430 03 1113 | 11x13 | 220 | 8.5 | 9 | 18.5 | 20 | 130 | 10 |
| 0430 03 1213 | 12x13 | 220 | 8.5 | 9 | 18.5 | 20 | 135 | 10 |
| 0430 03 1214 | 12x14 | 220 | 8.5 | 9.5 | 18.5 | 23 | 145 | 10 |
| 0430 03 1415 | 14x15 | 236 | 9.5 | 10 | 21.5 | 23 | 180 | 10 |
| 0430 03 1317 | 13x17 | 250 | 9 | 11.5 | 20 | 26.5 | 215 | 10 |
| 0430 03 1417 | 14x17 | 250 | 9.5 | 11.5 | 21.5 | 26.5 | 210 | 10 |
| 0430 03 1617 | 16x17 | 250 | 10.8 | 11.5 | 25 | 26.5 | 220 | 10 |
| 0430 03 1618 | 16x18 | 260 | 10.8 | 12 | 25 | 27.5 | 210 | 10 |
| 0430 03 1719 | 17x19 | 271 | 11.5 | 12.5 | 26.5 | 29 | 270 | 10 |
| 0430 03 1819 | 18x19 | 271 | 12 | 12.5 | 27.5 | 29 | 270 | 10 |
| 0430 03 1922 | 19x22 | 291 | 12.5 | 13.5 | 29 | 33 | 330 | 5 |
| 0430 03 1924 | 19x24 | 311 | 12.5 | 14.2 | 29 | 36.5 | 345 | 5 |
| 0430 03 2022 | 20x22 | 291 | 12.9 | 13.5 | 30.5 | 33 | 330 | 5 |
| 0430 03 2123 | 21x23 | 311 | 13.1 | 14 | 32 | 35 | 410 | 5 |
| 0430 03 2224 | 22x24 | 321 | 13.5 | 14.2 | 33 | 36.5 | 410 | 5 |
| 0430 03 2426 | 24x26 | 331 | 14.2 | 14.6 | 36.5 | 39.5 | 495 | 5 |
| 0430 03 2427 | 24x27 | 331 | 14.2 | 15 | 36.5 | 40.5 | 495 | 5 |
| 0430 03 2430 | 24x30 | 352 | 14.2 | 16.7 | 36.5 | 45 | 530 | 5 |
| 0430 03 2528 | 25x28 | 352 | 14.5 | 15.5 | 38 | 42.5 | 550 | 5 |
| 0430 03 2729 | 27x29 | 371 | 15 | 16.7 | 40.5 | 45 | 660 | 5 |
| 0430 03 2730 | 27x30 | 371 | 15 | 16.7 | 40.5 | 45 | 660 | 5 |
| 0430 03 2732 | 27x32 | 371 | 15 | 16.7 | 40.5 | 47.5 | 660 | 5 |
| 0430 03 3032 | 30x32 | 371 | 16.4 | 16.7 | 45 | 47.5 | 660 | 5 |
| 0430 03 3036 | 30x36 | 402 | 16.4 | 17.5 | 45 | 53 | 880 | 5 |
| 0430 03 3236 | 32x36 | 402 | 16.7 | 17.5 | 47.5 | 53 | 890 | 5 |
| 0430 03 3436 | 34x36 | 420 | 17.1 | 17.5 | 50 | 53 | 1000 | 5 |
| 0430 03 3641 | 36x41 | 438 | 17.5 | 19.5 | 53 | 61 | 1150 | 5 |
| 0430 03 4146 | 41x46 | 485 | 19.5 | 20.5 | 61 | 67.5 | 1430 | 5 |
| 0430 03 4650 | 46x50 | 535 | 20.5 | 22.4 | 67.5 | 73.5 | 1960 | 5 |

ÖZEL SERİLER (adet ve termin süresi isteyiniz)
SPECIAL SERIES (ask for quantity and delivery terms)

| | | | | | | | | |
|--------------|-------|-----|------|------|------|------|-----|----|
| 0430 03 1014 | 10x14 | 220 | 7.3 | 9 | 15.5 | 21.5 | 120 | 10 |
| 0430 03 1315 | 13x15 | 236 | 9 | 10 | 20 | 23 | 170 | 10 |
| 0430 03 2227 | 22x27 | 331 | 14.2 | 15 | 36.5 | 40.5 | 500 | 5 |
| 0430 03 3034 | 30x34 | 379 | 16.4 | 16.9 | 45 | 50 | 690 | 5 |

0430
Yıldız İki Ağız Anahtar Takımı (mm)
Double Ended Ring Wrench Set (mm)

| KOD CODE | İÇERİK CONTENTS | g | TL/Ad. |
|--------------|---|------|--------|
| 0430 00 2108 | 6x7 - 8x9 - 10x11 - 12x13 - 14x15 16x17 - 18x19 - 20x22 | 1450 | 8 |
| 0430 00 2112 | 6x7 - 8x9 - 10x11 - 12x13 - 14x15 16x17 - 18x19 - 20x22 - 21x23 24x26 - 25x28 - 27x32 | 3610 | 12 |

 (★) İşaretili olan ürünler stoklarla sınırlıdır.
Limited with stocks.

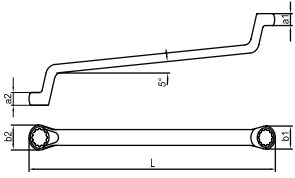
0431
Yıldız İki Ağız Anahtar (SAE)
Double Ended Ring Wrench (SAE)
TSEK

Krom vanadyum, Krom kaplı
Chrom vanadium, Chrom plated

| KOD CODE | inch | L mm | a1 mm | a2 mm | b1 mm | b2 mm | g | TL/ Ad. |
|--------------|-----------------|---------|----------|----------|----------|----------|-----|------------|
| 0431 03 0608 | 1/4"x5/16" | 176 | 5.6 | 6 | 10 | 11.5 | 55 | 10 |
| 0431 03 0809 | 5/16"x3/8" | 190 | 6.4 | 6.8 | 13 | 14.5 | 75 | 10 |
| 0431 03 0811 | 5/16"x7/16" | 190 | 6.4 | 7.3 | 13 | 15.5 | 115 | 10 |
| 0431 03 0911 | 3/8"x7/16" | 206 | 7.3 | 7.6 | 15.5 | 17 | 115 | 10 |
| 0431 03 1112 | 7/16"x1/2" | 220 | 8.5 | 9 | 18.5 | 20 | 135 | 10 |
| 0431 03 1214 | 1/2"x9/16" | 236 | 9 | 10 | 20 | 23 | 145 | 10 |
| 0431 03 1415 | 9/16"x19/32" | 236 | 9.5 | 10 | 21.5 | 23 | 165 | 10 |
| 0431 03 1416 | 9/16"x5/8" | 236 | 9.5 | 10 | 21.5 | 24 | 165 | 10 |
| 0431 03 1517 | 19/32"x11/16" | 250 | 10.8 | 11.5 | 25 | 26.5 | 210 | 10 |
| 0431 03 1920 | 3/4"x25/32" | 271 | 12 | 12.5 | 27.5 | 29 | 270 | 10 |
| 0431 03 2122 | 13/16"x7/8" | 311 | 13.1 | 14 | 32 | 35 | 400 | 5 |
| 0431 03 2325 | 15/16"x1" | 331 | 14.2 | 14.6 | 36.5 | 39.5 | 495 | 5 |
| 0431 03 2631 | 1 1/16"x1 1/4" | 371 | 15 | 16.7 | 40.5 | 48 | 640 | 5 |
| 0431 03 2833 | 1 1/8"x1 5/16" | 371 | 15 | 16.7 | 40.5 | 48 | 660 | 5 |
| 0431 03 3033 | 1 3/16"x1 5/16" | 371 | 16.4 | 16.7 | 45 | 48 | 670 | 5 |

ÖZEL SERİLER (adet ve termin süresi isteyiniz)
SPECIAL SERIES (ask for quantity and delivery terms)

| | | | | | | | | |
|--------------|-----------------|-----|------|------|------|------|------|----|
| 0431 03 1217 | 1/2"x11/16" | 250 | 9 | 10 | 20 | 26.5 | 185 | 10 |
| 0431 03 1417 | 9/16"x11/16" | 250 | 9.5 | 11.5 | 21.5 | 26.5 | 185 | 10 |
| 0431 03 1617 | 5/8"x11/16" | 250 | 10.8 | 11.5 | 25 | 26.5 | 210 | 10 |
| 0431 03 1619 | 5/8"x3/4" | 271 | 11.5 | 12.5 | 26.5 | 29 | 270 | 10 |
| 0431 03 2021 | 25/32"x13/16" | 291 | 12.9 | 13.5 | 30.5 | 33 | 270 | 5 |
| 0431 03 1922 | 3/4"x7/8" | 291 | 12.9 | 13.5 | 30.5 | 33 | 400 | 5 |
| 0431 03 2223 | 7/8"x15/16" | 321 | 13.5 | 14.2 | 33 | 36.5 | 400 | 5 |
| 0431 03 2328 | 15/16"x1 1/8" | 331 | 14.2 | 15 | 36.5 | 40.5 | 500 | 5 |
| 0431 03 2528 | 1"x1 1/8" | 352 | 14.5 | 15.5 | 38 | 42.5 | 570 | 5 |
| 0431 03 3036 | 1 3/16"x1 3/8" | 402 | 16.4 | 17.5 | 45 | 53 | 880 | 5 |
| 0431 03 3236 | 1 1/4"x1 7/16" | 402 | 16.7 | 17.5 | 48 | 53 | 890 | 5 |
| 0431 03 3641 | 1 7/16"x1 5/8" | 438 | 17.5 | 19.5 | 53 | 61 | 1100 | 5 |
| 0431 03 4146 | 1 11/16"x1 7/8" | 485 | 19.5 | 20.5 | 61 | 67.5 | 1390 | 5 |
| 0431 03 4650 | 1 13/16"x2" | 535 | 20.5 | 22.5 | 67.5 | 73.5 | 1955 | 5 |

0431
Yıldız İki Ağız Anahtar Takımı (SAE)
Double Ended Ring Wrench, Set (SAE)
TSEK

| KOD CODE | İÇERİK CONTENTS | g | TL/ Ad. |
|--------------|--|------|------------|
| 0431 00 2108 | 1/4"x5/16" - 5/16"x3/8" 7/16"x1/2" - 9/16"x5/8" 19/32"x11/16" 3/4"x25/32" - 13/16"x7/8" 15/16"x1" | 1915 | 8 |
| 0431 00 2112 | 1/4"x5/16" - 5/16"x3/8" 3/8"x7/16" - 7/16"x1/2" 9/16"x5/8" - 19/32"x11/16" 3/4"x25/32" - 13/16"x7/8" 15/16"x1" - 1 1/16"x1 1/4" 1 1/8"x1 5/16" 1 3/16"x1 5/16" | 3985 | 12 |

(★) İşaretili olan ürünler stoklarla sınırlıdır.
Limited with stocks.

Düz Yıldız Anahtar (mm)
Flat Ring Wrench (mm)

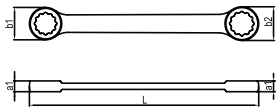
 TS 3794
 TS ISO 10103
 DIN 837 - B

 Krom vanadyum, Krom kaplı
 Chrom vanadium, Chrom plated

| KOD CODE | mm | L mm | a1 mm | b1 mm | b2 mm | g | TL/Ad. |
|--------------|-------|------|-------|-------|-------|-----|--------|
| 0440 03 0607 | 6x7 | 99 | 4.4 | 9.5 | 11 | 10 | 10 |
| 0440 03 0809 | 8x9 | 113 | 5.2 | 12.5 | 14 | 25 | 10 |
| 0440 03 1011 | 10x11 | 125 | 6 | 15.5 | 16.5 | 30 | 10 |
| 0440 03 1213 | 12x13 | 140 | 6.8 | 18.5 | 20 | 45 | 10 |
| 0440 03 1415 | 14x15 | 156 | 7.2 | 21 | 22.5 | 60 | 10 |
| 0440 03 1617 | 16x17 | 170 | 8 | 24 | 25 | 80 | 10 |
| 0440 03 1819 | 18x19 | 188 | 8.8 | 26.5 | 27.5 | 105 | 10 |
| 0440 03 2022 | 20x22 | 208 | 9.6 | 29 | 32 | 135 | 10 |
| 0440 03 2123 | 21x23 | 230 | 10.6 | 30 | 33 | 170 | 10 |
| 0440 03 2426 | 24x26 | 256 | 10.8 | 35 | 37.5 | 225 | 10 |
| 0440 03 2528 | 25x28 | 280 | 11.8 | 36 | 40.5 | 270 | 10 |
| 0440 03 2732 | 27x32 | 310 | 12.8 | 38.5 | 45.5 | 355 | 10 |

ÖZEL SERİLER (adet ve termin süresi isteyiniz)
SPECIAL SERIES (ask for quantity and delivery terms)

| | | | | | | | |
|--------------|-------|-----|------|------|------|-----|----|
| 0440 03 0810 | 8x10 | 120 | 5.6 | 12.5 | 15.5 | 30 | 10 |
| 0440 03 1013 | 10x13 | 140 | 6.8 | 18.5 | 20 | 45 | 10 |
| 0440 03 1315 | 13x15 | 156 | 7.2 | 20 | 22.5 | 55 | 10 |
| 0440 03 1317 | 13x17 | 165 | 7.8 | 20.2 | 25.2 | 85 | 10 |
| 0440 03 1618 | 16x18 | 188 | 8.8 | 26.5 | 27.5 | 90 | 10 |
| 0440 03 1719 | 17x19 | 188 | 8.8 | 26.5 | 27.5 | 105 | 10 |
| 0440 03 2224 | 22x24 | 230 | 10.8 | 32 | 35 | 170 | 10 |
| 0440 03 2427 | 24x27 | 256 | 10.8 | 35 | 38.5 | 225 | 10 |
| 0440 03 2729 | 27x29 | 290 | 12.8 | 38.5 | 42.5 | 285 | 10 |
| 0440 03 3032 | 30x32 | 310 | 12.8 | 43 | 45.5 | 360 | 10 |

0440
Düz Yıldız Anahtar Takımı (mm)
Flat Ring Wrench, Set (mm)

| KOD CODE | İÇERİK CONTENTS | g | TL/Ad. |
|--------------|---|------|--------|
| 0440 00 2108 | 6x7 - 8x9 - 10x11 - 12x13 - 14x15 16x17 - 18x19 - 20x22 | 560 | 8 |
| 0440 00 2112 | 6x7 - 8x9 - 10x11 - 12x13 - 14x15 16x17 - 18x19 - 20x22 - 21x23 24x26 - 25x28 - 27x32 | 1540 | 12 |

 (★) İşletli olan ürünler stoklarla sınırlıdır.
 Limited with stocks.

0435
Süper İzoleli Bir Ağız Yıldız Anahtar (mm)
Single Ended Ring Wrench Super Insulated (mm)

 △ 1000 V
 IEC 60900

Krom vanadyum, Krom kaplı, Kalın PVC izoleli
Chrom vanadium, Chrom plated, Triple PVC insulated

| KOD CODE | mm | L mm | g | TL/Ad. |
|--------------|----|------|-----|--------|
| 0435 03 0010 | 10 | 170 | 100 | 10 |
| 0435 03 0011 | 11 | 175 | 110 | 10 |
| 0435 03 0012 | 12 | 180 | 130 | 10 |
| 0435 03 0013 | 13 | 185 | 150 | 10 |
| 0435 03 0014 | 14 | 190 | 180 | 10 |
| 0435 03 0017 | 17 | 205 | 220 | 10 |
| 0435 03 0019 | 19 | 220 | 270 | 10 |
| 0435 03 0022 | 22 | 245 | 310 | 10 |
| 0435 03 0024 | 24 | 270 | 420 | 10 |

0530
Yarım Ay Anahtar Yıldız İki Ağız (mm)
Double - Hex Starter and Block Wrench (mm)

TSEK

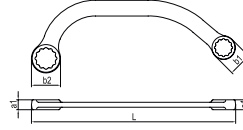
Krom vanadyum, Krom kaplı
Chrom vanadium, Chrom plated

| KOD CODE | mm | L mm | a1 mm | b1 mm | b2 mm | g | TL/Ad. |
|--------------|-------|------|-------|-------|-------|-----|--------|
| 0530 04 0810 | 8x10 | 120 | 6 | 12.5 | 15.5 | 30 | 10 |
| 0530 04 1011 | 10x11 | 150 | 7 | 17 | 20 | 55 | 10 |
| 0530 04 1012 | 10x12 | 150 | 7 | 17 | 20 | 55 | 10 |
| 0530 04 1113 | 11x13 | 150 | 7 | 17 | 20 | 55 | 10 |
| 0530 04 1315 | 13x15 | 185 | 9 | 21.5 | 26 | 110 | 10 |
| 0530 04 1317 | 13x17 | 185 | 9 | 21.5 | 26 | 105 | 10 |
| 0530 04 1417 | 14x17 | 185 | 9 | 21.5 | 26 | 110 | 10 |
| 0530 04 1517 | 15x17 | 185 | 9 | 21.5 | 26 | 100 | 10 |
| 0530 04 1922 | 19x22 | 230 | 11 | 29 | 33 | 195 | 10 |

0540
Rakor Anahtar (mm)
Flare Nut Wrench (mm)

DIN 3118

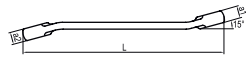
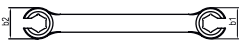
Krom vanadyum, Krom kaplı
Chrom vanadium, Chrom plated

| KOD CODE | mm | L mm | a1 mm | a2 mm | b1 mm | b2 mm | g | TL/Ad. |
|--------------|-------|------|-------|-------|-------|-------|-----|--------|
| 0540 01 0810 | 8x10 | 130 | 7 | 8.5 | 18 | 20 | 60 | 10 |
| 0540 01 1011 | 10x11 | 150 | 8.5 | 9.3 | 20 | 22 | 75 | 10 |
| 0540 01 1012 | 10x12 | 150 | 8.5 | 9.3 | 20 | 22 | 75 | 10 |
| 0540 01 1113 | 11x13 | 170 | 9.3 | 10.8 | 22 | 25.5 | 105 | 10 |
| 0540 01 1214 | 12x14 | 170 | 9.3 | 10.8 | 22 | 25.5 | 105 | 10 |
| 0540 01 1719 | 17x19 | 210 | 11.8 | 13 | 30.5 | 33.5 | 185 | 10 |
| 0540 01 1922 | 19x22 | 230 | 12.8 | 14.9 | 33.5 | 39.5 | 235 | 10 |

0531
Yarım Ay Anahtar Yıldız İki Ağız (SAE)
Double - Hex Starter and Block Wrench (SAE)

TSEK

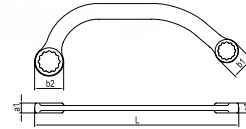

Krom vanadyum, Krom kaplı
Chrom vanadium, Chrom plated

| KOD CODE | inch | L mm | a1 mm | b1 mm | b2 mm | g | TL/Ad. |
|--------------|------------|------|-------|-------|-------|-----|--------|
| 0531 04 1112 | 7/16"x1/2" | 150 | 7 | 17 | 20 | 50 | 10 |
| 0531 04 1214 | 1/2"x9/16" | 185 | 9 | 21.5 | 26 | 110 | 10 |
| 0531 04 1416 | 9/16"x5/8" | 185 | 9 | 21.5 | 26 | 115 | 10 |
| 0531 04 1922 | 3/4"x7/8" | 230 | 11 | 29 | 33 | 195 | 10 |

ÖZEL SERİLER (adet ve termin süresi isteyiniz)
SPECIAL SERIES (ask for quantity and delivery terms)

| | | | | | | | |
|--------------|--------------|-----|---|------|------|-----|----|
| 0531 04 0809 | 5/16"x3/8" | 120 | 6 | 12.5 | 15.5 | 30 | 10 |
| 0531 04 0911 | 3/8"x7/16" | 150 | 7 | 17 | 20 | 50 | 10 |
| 0531 04 1417 | 9/16"x11/16" | 185 | 9 | 21.5 | 26 | 110 | 10 |

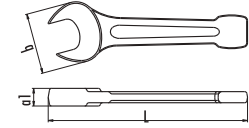
Çatal Çakma Anahtar (mm)
Slugging Open Jaw Wrench (mm)

 TS 81
 DIN 133

Krom vanadyum
Chrom vanadium

| KOD CODE | mm | L mm | a1 mm | b mm | g | TL/Ad. |
|--------------|-----|------|-------|------|-------|--------|
| 0700 05 0024 | 24 | 160 | 14 | 50 | 280 | 1 |
| 0700 05 0027 | 27 | 180 | 15 | 55 | 385 | 1 |
| 0700 05 0030 | 30 | 190 | 16 | 64 | 525 | 1 |
| 0700 05 0032 | 32 | 190 | 16 | 64 | 530 | 1 |
| 0700 05 0036 | 36 | 210 | 18 | 75 | 755 | 1 |
| 0700 05 0038 | 38 | 210 | 18 | 75 | 760 | 1 |
| 0700 05 0041 | 41 | 230 | 18 | 85 | 920 | 1 |
| 0700 05 0042 | 42 | 230 | 18 | 85 | 930 | 1 |
| 0700 05 0046 | 46 | 255 | 20 | 95 | 1305 | 1 |
| 0700 05 0047 | 47 | 255 | 20 | 95 | 1320 | 1 |
| 0700 05 0050 | 50 | 275 | 20 | 105 | 1565 | 1 |
| 0700 05 0055 | 55 | 310 | 23 | 119 | 2305 | 1 |
| 0700 05 0060 | 60 | 310 | 23 | 119 | 2310 | 1 |
| 0700 05 0065 | 65 | 340 | 28 | 135 | 3300 | 1 |
| 0700 05 0070 | 70 | 375 | 31 | 154 | 4555 | 1 |
| 0700 05 0075 | 75 | 375 | 31 | 154 | 4460 | 1 |
| 0700 05 0080 | 80 | 405 | 34 | 169 | 6115 | 1 |
| 0700 05 0085 | 85 | 405 | 34 | 169 | 5740 | 1 |
| 0700 05 0090 | 90 | 445 | 38 | 189 | 8040 | 1 |
| 0700 05 0095 | 95 | 445 | 38 | 189 | 8160 | 1 |
| 0700 05 0100 | 100 | 485 | 44 | 214 | 12355 | 1 |
| 0700 05 0105 | 105 | 485 | 44 | 214 | 11785 | 1 |
| 0700 05 0110 | 110 | 510 | 50 | 234 | 15000 | 1 |
| 0700 05 0115 | 115 | 510 | 50 | 234 | 14830 | 1 |
| 0700 05 0120 | 120 | 543 | 54 | 254 | 18865 | 1 |

ÖZEL SERİLER (adet ve termin süresi isteyiniz)
SPECIAL SERIES (ask for quantity and delivery terms)

| | | | | | | |
|--------------|-----|-----|------|-----|-------|---|
| 0700 05 0125 | 125 | 543 | 54 | 254 | 17250 | 1 |
| 0700 05 0130 | 130 | 560 | 56 | 275 | 20000 | 1 |
| 0700 05 0135 | 135 | 560 | 56 | 275 | 19700 | 1 |
| 0700 05 0140 | 140 | 630 | 58.5 | 310 | 19400 | 1 |
| 0700 05 0145 | 145 | 630 | 58.5 | 310 | 28000 | 1 |
| 0700 05 0150 | 150 | 630 | 58.5 | 310 | 27600 | 1 |

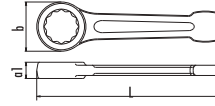
Yıldız Çakma Anahtar (mm)
Slugging Ring Wrench (mm)

 TS 3794
 DIN 7444

Krom vanadyum
Chrom vanadium

| KOD CODE | mm | L mm | a1 mm | b mm | g | TL/Ad. |
|--------------|-----|------|-------|------|-------|--------|
| 0750 05 0024 | 24 | 160 | 15 | 41.5 | 235 | 1 |
| 0750 05 0027 | 27 | 180 | 16 | 45.5 | 325 | 1 |
| 0750 05 0030 | 30 | 190 | 17 | 51 | 435 | 1 |
| 0750 05 0032 | 32 | 190 | 17 | 51 | 425 | 1 |
| 0750 05 0036 | 36 | 205 | 19 | 58 | 550 | 1 |
| 0750 05 0038 | 38 | 205 | 19 | 58 | 530 | 1 |
| 0750 05 0041 | 41 | 225 | 20 | 63 | 730 | 1 |
| 0750 05 0042 | 42 | 225 | 20 | 63 | 700 | 1 |
| 0750 05 0046 | 46 | 240 | 22 | 71 | 970 | 1 |
| 0750 05 0047 | 47 | 240 | 22 | 71 | 930 | 1 |
| 0750 05 0050 | 50 | 255 | 23 | 77 | 1160 | 1 |
| 0750 05 0055 | 55 | 272 | 25 | 88 | 1520 | 1 |
| 0750 05 0060 | 60 | 272 | 25 | 88 | 1460 | 1 |
| 0750 05 0065 | 65 | 300 | 28 | 98 | 2025 | 1 |
| 0750 05 0070 | 70 | 330 | 32 | 108 | 2890 | 1 |
| 0750 05 0075 | 75 | 330 | 32 | 108 | 2755 | 1 |
| 0750 05 0080 | 80 | 360 | 35 | 126 | 4000 | 1 |
| 0750 05 0085 | 85 | 360 | 35 | 126 | 3620 | 1 |
| 0750 05 0090 | 90 | 390 | 40 | 140 | 5465 | 1 |
| 0750 05 0095 | 95 | 390 | 40 | 140 | 5250 | 1 |
| 0750 05 0100 | 100 | 420 | 44 | 148 | 6755 | 1 |
| 0750 05 0105 | 105 | 420 | 44 | 148 | 6445 | 1 |
| 0750 05 0110 | 110 | 450 | 48 | 166 | 8500 | 1 |
| 0750 05 0115 | 115 | 450 | 48 | 166 | 8460 | 1 |
| 0750 05 0120 | 120 | 490 | 54 | 178 | 10000 | 1 |

ÖZEL SERİLER (adet ve termin süresi isteyiniz)
SPECIAL SERIES (ask for quantity and delivery terms)

| | | | | | | |
|--------------|-----|-----|------|-----|-------|---|
| 0750 05 0125 | 125 | 490 | 54 | 178 | 9900 | 1 |
| 0750 05 0130 | 130 | 518 | 59 | 196 | 16000 | 1 |
| 0750 05 0135 | 135 | 518 | 59 | 196 | 15900 | 1 |
| 0750 05 0140 | 140 | 518 | 59 | 196 | 15800 | 1 |
| 0750 05 0145 | 145 | 580 | 61.8 | 223 | 22000 | 1 |
| 0750 05 0150 | 150 | 580 | 61.8 | 223 | 21900 | 1 |
| 0750 05 0155 | 155 | 580 | 61.8 | 223 | 21800 | 1 |
| 0750 05 0160 | 160 | 580 | 61.8 | 223 | 21700 | 1 |
| 0750 05 0165 | 165 | 648 | 67 | 262 | 30000 | 1 |
| 0750 05 0170 | 170 | 648 | 67 | 262 | 29800 | 1 |
| 0750 05 0180 | 180 | 648 | 67 | 262 | 29700 | 1 |

 (★) İşaretili olan ürünler stoklarla sınırlıdır.
Limited with stocks.

0550

Boru Uzatmalı Yıldız Anahtar (mm) Offset Ring Wrench (mm)

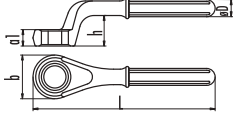

Krom vanadyum, Krom kaplı
Chrom vanadium, Chrom plated

| KOD CODE | mm | L mm | a1 mm | b mm | σD mm | h mm | g | TL/Ad. |
|--------------|----|------|-------|------|-------|------|------|--------|
| 0550 05 0024 | 24 | 180 | 17 | 37 | 18.5 | 30 | 400 | 1 |
| 0550 05 0027 | 27 | 190 | 18 | 42 | 18.5 | 33 | 450 | 1 |
| 0550 05 0030 | 30 | 200 | 20 | 46 | 18.5 | 34 | 520 | 1 |
| 0550 05 0032 | 32 | 235 | 21.5 | 49 | 21.2 | 37 | 700 | 1 |
| 0550 05 0036 | 36 | 245 | 23 | 53.5 | 21.2 | 42 | 830 | 1 |
| 0550 05 0038 | 38 | 270 | 25 | 60.5 | 21.2 | 43 | 965 | 1 |
| 0550 05 0041 | 41 | 270 | 25 | 60.5 | 21.2 | 43 | 950 | 1 |
| 0550 05 0046 | 46 | 280 | 26 | 68 | 24.2 | 45 | 1240 | 1 |
| 0550 05 0050 | 50 | 290 | 28 | 74 | 24.2 | 47 | 1410 | 1 |
| 0550 05 0055 | 55 | 300 | 30 | 79 | 24.2 | 50 | 1550 | 1 |
| 0550 05 0060 | 60 | 345 | 32 | 89 | 29 | 50.5 | 2390 | 1 |
| 0550 05 0065 | 65 | 355 | 34 | 98 | 29 | 56.5 | 2730 | 1 |

ÖZEL SERİLER (adet ve termin süresi isteyiniz) SPECIAL SERIES (ask for quantity and delivery terms)

| | | | | | | | | |
|--------------|-----|-----|------|-----|------|------|------|---|
| 0550 05 0022 | 22 | 180 | 17 | 37 | 18.5 | 30 | 400 | 1 |
| 0550 05 0034 | 34 | 235 | 21.5 | 49 | 21.2 | 37 | 750 | 1 |
| 0550 05 0070 | 70 | 365 | 37 | 104 | 29 | 55 | 2900 | 1 |
| 0550 05 0075 | 75 | 375 | 40 | 109 | 29 | 57.5 | 3100 | 1 |
| 0550 05 0080 | 80 | 385 | 43 | 124 | 29 | 59 | 3900 | 1 |
| 0550 05 0085 | 85 | 385 | 43 | 124 | 29 | 59 | 3750 | 1 |
| 0550 05 0090 | 90 | 410 | 46 | 140 | 29 | 63 | 5100 | 1 |
| 0550 05 0095 | 95 | 410 | 46 | 140 | 29 | 63 | 4950 | 1 |
| 0550 05 0100 | 100 | 420 | 46 | 150 | 29 | 65 | 4800 | 1 |

0551

Döndürme Kolu Borusu Tubular Handle



Dikişsiz Çelik Boru
Seamless Steel Pipe

| KOD CODE | mm | L mm | σ mm | g | TL/Ad. |
|--------------|----------|------|------|------|--------|
| 0551 05 0001 | 22 - 30 | 460 | 25 | 700 | 1 |
| 0551 05 0002 | 32 - 41 | 610 | 27 | 1220 | 1 |
| 0551 05 0003 | 46 - 55 | 760 | 32.2 | 1880 | 1 |
| 0551 05 0004 | 60 - 100 | 860 | 38 | 2975 | 1 |

0600

Kurbağacık Anahtar Adjustable Wrench



TS 3796
DIN 3117



İZELTAS YOUTUBE

Yedek parça sayfa 198
Spare parts page 198

Krom vanadyum, Krom kaplı, PVC izoleli
Chrom vanadium, Chrom plated, PVC insulated

| KOD CODE | L mm | L inch | a mm | g | TL/Ad. |
|--------------|------|--------|------|------|--------|
| 0600 01 1006 | 160 | 6" | 18 | 120 | 5 |
| 0600 01 1008 | 208 | 8" | 23 | 230 | 5 |
| 0600 01 1010 | 260 | 10" | 28 | 400 | 5 |
| 0600 01 1012 | 308 | 12" | 34 | 670 | 5 |
| 0600 01 1015 | 388 | 15" | 43 | 1555 | 1 |

0860

Kanca Anahtar (dörtgen uçlu) Hook Wrench

TS 3798 • DIN 1810

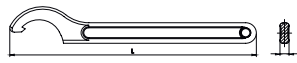

Krom vanadyum, Krom kaplı
Chrom vanadium, Chrom plated

| KOD CODE | mm | L mm | a1 mm | g | TL/Ad. |
|--------------|--------|------|-------|-----|--------|
| 0860 05 2528 | 25/28 | 136 | 4 | 50 | 10 |
| 0860 05 3032 | 30/32 | 136 | 4 | 50 | 10 |
| 0860 05 3436 | 34/36 | 171 | 5 | 95 | 10 |
| 0860 05 4042 | 40/42 | 171 | 5 | 95 | 10 |
| 0860 05 4550 | 45/50 | 210 | 6 | 160 | 10 |
| 0860 05 5255 | 52/55 | 210 | 6 | 160 | 10 |
| 0860 05 5862 | 58/62 | 242 | 7 | 270 | 5 |
| 0860 05 6875 | 68/75 | 242 | 7 | 270 | 5 |
| 0860 05 8090 | 80/90 | 281 | 8 | 400 | 5 |
| 0860 05 9510 | 95/100 | 281 | 8 | 400 | 5 |

(★) İşaretili olan ürünler stoklarla sınırlıdır.
Limited with stocks.

Ayarlı Montaj Anahtarı
Adjustable Speed Wrench

İZELTAŞ USTA İŞİ
SOHBETLER

Yedek parça sayfa 198
Spare parts page 198

Krom vanadyum, Krom kaplı
Chrom vanadium, Chrom plated

| KOD CODE | L mm | L inch | a mm | g | | TL/Ad. |
|--------------|---------|-----------|---------|-------|---|--------|
| 0615 01 0200 | 200 | 8" | 6-22 | 220 | 5 | |

6 ile 22 mm arası **Altı Köşe, Torx, XZN, Ribe, Kare** gibi farklı geometriye sahip cıvataları açabilme imkanı sağlar. Anahtarı cıvata başından tam olarak çıkarmadan açma ve sıkma hareketi olanağı sağlar. Anahtar sapına özel olarak açılmış 10-13-15 mm altı köşe cıvataları açabilme imkanı sağlar

*Allows to open bolts with different geometry such as **Hexagon, Torx, XZN, Ribe, Square** in sizes from 6 to 22 mm. Enables unbolting and tightening turn without removing the wrench completely from the bolt head. Specially opened 10-13-15 mm holes on the handle, allows to open hexagon bolts.*



MCD ÇOK NOKTADAN TEMAS PROFİLİ / MCD MULTI CONTACT DRIVE PROFILE



İzeltaş Yeni Jenerasyon Yıldız Anahtar Profili

MCD, Multi Contact Drive (çoklu temas), sıkma performansının geliştirilmesi amacıyla dizayn edilmiştir. Bilgisayar destekli titiz çalışmaların sonucunda geliştirilen MCD, klasik 12 köşe anahtardan çok daha kullanışlı, çok daha güçlüdür.

En önemli özelliği, yıldız kafadaki çoklu temas yüzeyleridir. Bu sayede civata ve somunla maksimum temas sağlanır. Böylece basınç tüm köşelere eşit olarak dağılır, temas edilen yüzeylerdeki olası hasarlar önlenir, aletin ömrü uzar.

- Yıldız kafadaki yeni profil, düzenli bir dalga şeklindedir. Güç, civatanın köşelerine değil, yan yüzeylerine etki eder (çoklu temas). Basınç daha dengeli dağıldığından temas edilen yüzeylerde ezilme meydana gelmez.
- Tolerans dışı civatalar için de uygundur.
- Civata başlarının köşelerini ezmez.
- Geniş temas alanı, anahtar ömrünü arttırır.
- Bozuk ve deforme olmuş civataları kolayca açar.

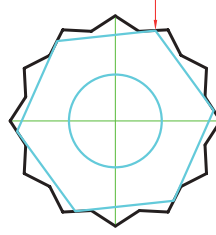

Çoklu Temas / Multi Point Contact

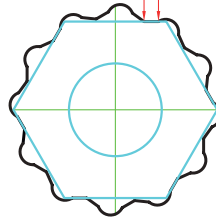

MCD Profil
MCD Profile

IZELTAS New Generation Ring Wrench Profile

MCD (Multi Contact Drive) is designed to improve the driving performance of the ring wrench. MCD, designed through computer aided drafting, transmits more torque and has longer life than conventional 12 edge ring profile.

Multi point contact is the source of effectiveness, where maximum surface area is in touch with fastener flats. Increased contact also maximizes tool's life through decreased pressure on the contact points.

- New profile of the ring wrench is formed of curves. Torque is transmitted through these curves rather than edges. As the stress is balanced between enlarged surfaces, the risk of deformation is minimized.
- It is possible to drive off-tolerance fasteners.
- Does not deform the fastener edges.
- Larger contact area increases tool's life.
- Works well with deformed fasteners.

MONTAJ ANAHTARI / SPEED WRENCH



%100 Daha Hızlı

Yeni tasarlanan montaj anahtarı, 2 kat hızını cırcır mekanizması mantığına dayanan çalışma prensibinden alır. Kullanım sırasında, montaj anahtarını civatadan ayırmadan döndürme kolaylığı kullanım hızını arttırırken, civata köşelerine sağlam tutunan anahtar profili güvenli ve kaydırmaz kullanım sağlar.

Uzun Ömür

Bu yeni montaj anahtarı profili, civata ve somunlar ile köşelerinden değil düz yüzeyleri üzerinden temas ederek düzenli tork iletimini sağlarken, gerilimin artmasını da engelleyerek anahtar ömrünün uzamasını sağlar.

- Anahtarı civatadan ayırmadan hızlı kullanım.
- Güvenli tork iletimi ve uzun ömür.

100% Faster

New designed speed wrench takes its 100% faster rotational drive from the ratchet mechanism principle. Rotating the tool without the need for removing from the fastener provides faster usage, while enabling safer and slip-free usage with fully gripping upper and lower jaws.

Longer Tool Life

This new speed wrench profile contacts the fasteners from their flats rather than edges, which provides balanced torque transmission and decreases stress accumulation on the edges increasing the tool life considerably.

- Fast drive without removing the wrench from the fastener.
- Firm torque transmission and longer life.

AYARLI MONTAJ ANAHTARI / ADJUSTABLE SPEED WRENCH



6 ile 22 mm arası altı köşe, torx, yive, ribe, kare gibi farklı geometriye sahip civataları açabilme imkanı sağlar. Anahtarı civata başından tam olarak çıkarmadan açma ve sıkma hareketi olanağı sağlar. Anahtar sapına özel olarak açılmış 10-13-15 mm altı köşe civataları açabilme imkanı sağlar

This tool is used for all different shapes of bolts between 6 and 22 mm. Contact between the tool and bolt is not removed to loosen and tighten the bolt. With the hexagonal holes in the handle, tool also can be used for 10-13-15mm bolts and nuts.

(★) İşaretili olan ürünler stoklarla sınırlıdır.
Limited with stocks.



İZELTAS®

LOKMA VE BİJON ANAHTARLARI

SOCKETS AND RIM WRENCHES

Lokma Anahtarlar
Socket Wrenches

Lokma Takımları
Socket Wrench Sets

Kovan Anahtarlar
Tubular Socket Wrenches

Bijon Anahtarlar
Rim Wrenches

Tork Anahtarları
Torque Wrenches



İZELTAS YOUTUBE

SOCKETS AND
RIM WRENCHES

LOKMA BİJON
ANAHTARLARI

Tork (Moment) ve Kuvvet / Torque (Moment) and Force

» Bilindiği üzere kuvvet bir cisme hareketini veren etkidir. Tork ise cismin bir kuvvet etkisinde döndürülmesidir. Bağlantı elemanlarını sıkma işlemlerinde genel olarak yıldız, çatal ya da lokma anahtar gibi çeşitli el aletleri kullanılır. Bu işlem fiziksel olarak işlevsel ve doğru olarak gözükse de vida, civata bağlantısının güvenilirliği açısından doğru bir çalışma şekli değildir. Bir vida-civata bağlantısının çözülmeye karşı en büyük emniyeti teorik olarak hesaplanmış olan tork değeri ile sıkılmasıdır. Bu da ancak çeşitli modern yöntemler ile sağlanabilir. Örneğin; tork anahtarı ile sıkmak, motor tahrikli sıkma işlemleri, ultrason ile sıkmak gibi. Çeşitli uygulamalar tork anahtarı kullanımının daha makul olduğunu göstermiştir.

» As you know, force is the effect which imparts movement to an object. Torque, is rotation of an object under effect of force. Various hand tools like a Philips head screwdriver, for spanner or socket wrench are used to tighten connection elements. While this process appears functional and correct, it is not an appropriate procedure for reliability of the threaded connection. The greatest safety of a threaded connection against loosening is being tightened at a certain torque level theoretically calculated beforehand. This can only be ensured with various modern methods. For example, tightening with a torque wrench, motor-driven tightening or ultrasound supported tightening. Various applications have shown that use of a torque wrench is more appropriate.

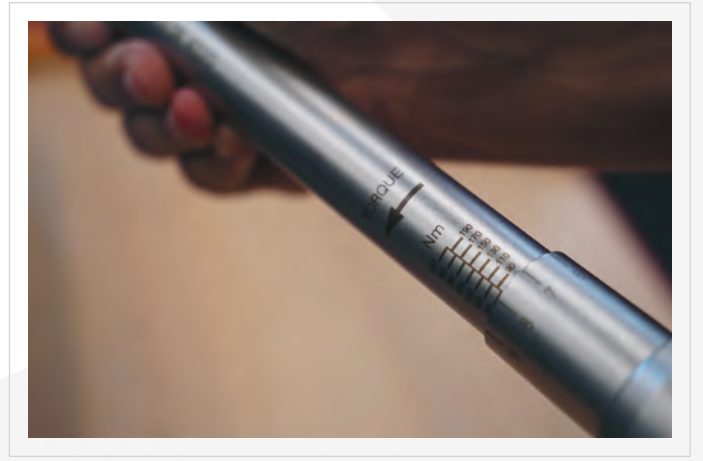

Sıkma Torku Nedir ?

» Sıkma torku, kuvvet etkisiyle döndürme kolunun uç kısmındaki anahtar ağızında oluşturulur ve birimi Nm'dir. Bu sıkma torku vida bağlantısında bir ön gerilme yaratır. Sıkma torkunun olması gerekenden düşük olması, zamanla oluşabilecek titreşimler sebebiyle vida-civata bağlantısında gevşeme/çözülmeye yol açabilir. Ön gerilme kuvveti fazlaca oluşan bağlantılarda ise parçalara zarar verebilir, aynı zamanda vida üzerindeki dişlerde meydana gelecek aşınmalar bağlantıyı çözülemez kılabilir.

What Is Tightening Torque ?

» Tightening torque is generated at the wrench tip at the terminus of the rotating lever under the effect of force, and its unit is Nm. This tightening torque creates a pre-tension on the threaded connection. Tightening torque being lower than what is necessary can cause the threaded connection to loosen/unravel due to vibrations that might occur over time. On the other hand, pre-tension force being over what is necessary can cause damage on the connection parts, as well as causing the threads on the connection piece to wear off or causing the connection become non-severable.

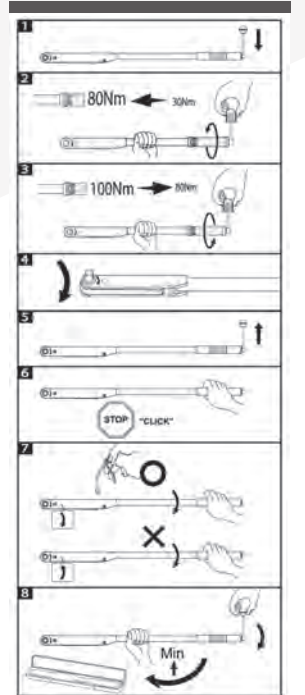

Tork Anahtarlarının Doğru Kullanımı

- » Tork anahtarı ile çalışılırken dikkat edilmesi gereken bazı hususlar bulunmaktadır. Bunlardan başlıcaları;
- Hangi tip tork anahtarı olursa olsun döndürme yönünün aksine kuvvet uygulanmaması gereklidir.
 - Cırcır anahtarlar gibi tork anahtarlarının da sökme işlemi için kullanılmaması gerekir.
 - Klik sesli modellerde klik sesi duyulduğu anda ayarlanmış tork değerine ulaşılmış demektir, daha fazla kuvvet uygulanmamalıdır.
 - Gövdesi hasar görmüş, mekanizması bozulmuş tork anahtarlarını kullanmaya devam etmeyiniz.
 - Kuvvet, tork anahtarının sap kısmından uygulanmalıdır.
 - Kullanımdan sonra nemden ve kirden korumak için her zaman kutusunda muhafaza ediniz.
 - Her kullanımdan sonra tork anahtarındaki yükü "0 Nm" konumuna getiriniz.
 - Tork anahtarlarını kendi başınıza tamir etmeye çalışmayınız.



Tork Anahtarlarının Kalibrasyonu

- » Tork anahtarlarının doğru çalışması ve bağlantıların sağlıklı sıkılabilmesi için kalibrasyon işlemi büyük önem arz etmektedir. TS EN ISO 6789-1 Standardına göre tork anahtarlarının ilk kullanımdan itibaren geçerli olmak üzere 12 aylık bir periyotta veya her 5000 kullanımlık çevrim sonunda kalibre edilmesi önerilmektedir.

Calibration Of Torque Wrenches

- » Calibration process carries great importance for torque wrenches to function correctly and be able to tighten connections in a healthy fashion. TS EN ISO 6789-1 Standard stipulates torque wrenches should be calibrated with 12 month periods or after each cycle of 5000 uses starting from the first use.

Correct Use Of Torque Wrenches

- » There are some important points that must be kept in mind when working with a torque wrench. Some of these include the following.
- No matter which type of torque wrench is used, force should not be applied at the opposite of rotating direction.
 - Torque wrenches like ratchet wrenches should not be used to loosen connections.
 - In models with click sound option, the click indicates the set torque value is achieved and further force should not be applied from then on.
 - Do not continue using torque wrenches with a damaged body or mechanism.
 - Force should be applied at the handle part of the torque wrench.
 - The tool should always be kept in its box after use to protect against moisture and dirt.
 - The load set of the torque wrench should be adjusted to "0 Nm" after each use.
 - Please do not attempt to repair torque wrenches on your own.



Nikel üzeri krom kaplama ile korozyon direncinde üst seviye koruma
Corrosion protection with nickel over chrome plating

Yüksek dayanım için üst toleranslarda tasarım
Improved durability with upper tolerance thickness

En uygun temas yüzeyi için hassas dövülmüş altı köşe ağızlar
Precise forged hex shape for best contact area



Bilya stoplama yuvalı hassas işlenmiş kare kanal
Precise machined square adapter with ball stopper Groove

Yüksek mukavemetli alaşımlı sıcak dövme çeliği
High strength alloyed forged steel

Extra sürtünme kabiliyeti için tırtıklı tasarım
Extra friction capability with knurled design



İZELTAS USTA İŞİ
SOHBETLER



İZELTAS YOUTUBE

1107

1/4" Altı Köşe Lokma Anahtar (mm) Socket Wrench 6 Points (mm)

TS ISO 2725 -1
DIN 3124

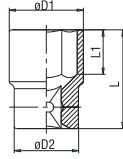

1/4"

Krom vanadyum, Krom kaplı, Polijalı
Chrom vanadium, Chrom plated, Polished

| KOD CODE | mm | ø D1 mm | ø D2 mm | L mm | L1 mm | g | TL/Ad. |
|--------------|-----|---------|---------|------|-------|----|--------|
| 1107 06 0004 | 4 | 6.8 | 11.8 | 25 | 4 | 10 | 10 |
| 1107 06 0045 | 4.5 | 7.4 | 11.8 | 25 | 5 | 10 | 10 |
| 1107 06 0005 | 5 | 8 | 11.8 | 25 | 6 | 10 | 10 |
| 1107 06 0055 | 5.5 | 8.5 | 11.8 | 25 | 6 | 10 | 10 |
| 1107 06 0006 | 6 | 9.2 | 11.8 | 25 | 7 | 10 | 10 |
| 1107 06 0007 | 7 | 10.8 | 11.8 | 25 | 7 | 10 | 10 |
| 1107 06 0008 | 8 | 11.9 | 11.8 | 25 | 8 | 10 | 10 |
| 1107 06 0009 | 9 | 12.9 | 12.8 | 25 | 8 | 15 | 10 |
| 1107 06 0010 | 10 | 14.3 | 14.3 | 25 | 9 | 20 | 10 |
| 1107 06 0011 | 11 | 15.8 | 15.8 | 25 | 9 | 20 | 10 |
| 1107 06 0012 | 12 | 16.8 | 16.8 | 25 | 9 | 25 | 10 |
| 1107 06 0013 | 13 | 17.8 | 17.8 | 25 | 9 | 30 | 10 |

1107

1/4" Altı Köşe Derin Lokma Anahtar (mm) Deep Socket Wrench 6 Points (mm)

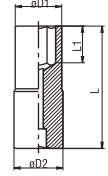

1/4"

Krom vanadyum, Krom kaplı, Polijalı
Chrom vanadium, Chrom Plated, Polished

| KOD CODE | mm | ø D1 mm | ø D2 mm | L mm | L1 mm | g | TL/Ad. |
|--------------|-----|---------|---------|------|-------|----|--------|
| 1107 06 4004 | 4 | 6.8 | 11.8 | 50 | 6 | 10 | 10 |
| 1107 06 4005 | 5 | 8 | 11.8 | 50 | 7 | 20 | 10 |
| 1107 06 4055 | 5.5 | 8.7 | 11.8 | 50 | 9 | 20 | 10 |
| 1107 06 4006 | 6 | 9.2 | 11.8 | 50 | 9 | 25 | 10 |
| 1107 06 4007 | 7 | 10.8 | 11.8 | 50 | 15 | 25 | 10 |
| 1107 06 4008 | 8 | 11.8 | 11.8 | 50 | 15 | 25 | 10 |
| 1107 06 4009 | 9 | 13 | 13 | 50 | 15 | 30 | 10 |
| 1107 06 4010 | 10 | 14.5 | 14.5 | 50 | 15 | 40 | 10 |
| 1107 06 4011 | 11 | 15.8 | 15.8 | 50 | 21 | 45 | 10 |
| 1107 06 4012 | 12 | 16.8 | 16.8 | 50 | 21 | 50 | 10 |
| 1107 06 4013 | 13 | 17.8 | 17.8 | 50 | 21 | 55 | 10 |

1107

1/4" Derin Lokma Anahtar Set (14 parça, mm) Deep Socket Wrench Set Type (14 pcs, mm)



1/4"

| KOD CODE | LOKMLAR Sockets | AVADANLIKLAR Accessories | g | TL/Ad. |
|--------------|---|--|------|--------|
| 1107 00 6014 | 4-5-5.5-6 7-8-9-10 11-12-13 Altı Köşe Derin Lokma Deep Socket Wrench 6 Points | 1/4" Cırcır Kol Ratchet Handle 1/4" Ara Kol Extension Bar 50 mm 1/4" Ara Kol Extension Bar 100 mm | 1005 | 14 |

Havallı aletler ile kullanmayınız / Do not use with power-tools

1107

1/4" Lokmalı Allen Uç
Hexagonal Bit Socket Wrench



1/4"

Krom vanadyum, Krom Kaplı
Chrom vanadium, Chrom Plated

| KOD CODE | mm | L mm | g | | TL/Ad. |
|--------------|-----|------|----|----|--------|
| 1107 06 1125 | 2.5 | 37 | 13 | 10 | |
| 1107 06 1103 | 3 | 37 | 13 | 10 | |
| 1107 06 1104 | 4 | 37 | 15 | 10 | |
| 1107 06 1105 | 5 | 37 | 15 | 10 | |
| 1107 06 1106 | 6 | 37 | 15 | 10 | |
| 1107 06 1107 | 7 | 37 | 16 | 10 | |
| 1107 06 1108 | 8 | 37 | 17 | 10 | |
| 1107 06 1110 | 10 | 37 | 19 | 10 | |

1107

1/4" Lokmalı Star (Torx®) Uç
Torx Bit Socket Wrench



1/4"

Krom vanadyum, Krom Kaplı
Chrom vanadium, Chrom Plated

| KOD CODE | | L mm | g | | TL/Ad. |
|--------------|-----|------|----|----|--------|
| 1107 06 1208 | T8 | 37 | 12 | 10 | |
| 1107 06 1209 | T9 | 37 | 12 | 10 | |
| 1107 06 1210 | T10 | 37 | 13 | 10 | |
| 1107 06 1215 | T15 | 37 | 14 | 10 | |
| 1107 06 1220 | T20 | 37 | 14 | 10 | |
| 1107 06 1225 | T25 | 37 | 14 | 10 | |
| 1107 06 1227 | T27 | 37 | 14 | 10 | |
| 1107 06 1230 | T30 | 37 | 15 | 10 | |
| 1107 06 1240 | T40 | 37 | 16 | 10 | |

Havali aletler ile kullanmayınız / Do not use with power-tools

1107

1/4" Lokmalı Star Delikli (Torx®) Uç
Tamper Resistant Torx Bit Socket Wrench



1/4"

Krom vanadyum, Krom Kaplı
Chrom vanadium, Chrom Plated

| KOD CODE | | L mm | g | | TL/Ad. |
|--------------|------|------|----|----|--------|
| 1107 06 1308 | TR8 | 37 | 13 | 10 | |
| 1107 06 1309 | TR9 | 37 | 13 | 10 | |
| 1107 06 1310 | TR10 | 37 | 13 | 10 | |
| 1107 06 1315 | TR15 | 37 | 14 | 10 | |
| 1107 06 1320 | TR20 | 37 | 14 | 10 | |
| 1107 06 1325 | TR25 | 37 | 14 | 10 | |
| 1107 06 1327 | TR27 | 37 | 14 | 10 | |
| 1107 06 1330 | TR30 | 37 | 15 | 10 | |
| 1107 06 1340 | TR40 | 37 | 16 | 10 | |

1107

1/4" Lokmalı Düz Uç
Slotted Bit Socket Wrench



1/4"

Krom vanadyum, Krom Kaplı
Chrom vanadium, Chrom Plated

| KOD CODE | | L mm | g | | TL/Ad. |
|--------------|-----|------|----|----|--------|
| 1107 06 1403 | 3 | 37 | 13 | 10 | |
| 1107 06 1435 | 3.5 | 37 | 14 | 10 | |
| 1107 06 1404 | 4 | 37 | 14 | 10 | |
| 1107 06 1445 | 4.5 | 37 | 14 | 10 | |
| 1107 06 1455 | 5.5 | 37 | 15 | 10 | |
| 1107 06 1465 | 6.5 | 37 | 15 | 10 | |
| 1107 06 1407 | 7 | 37 | 16 | 10 | |
| 1107 06 1408 | 8 | 37 | 16 | 10 | |
| 1107 06 1410 | 10 | 37 | 17 | 10 | |

(*) İşaretili olan ürünler stoklarla sınırlıdır.
Limited with stocks.

1107

1/4" Lokmalı Yıldız Uç Phillips Bit Socket Wrench



1/4"

Krom vanadyum, Krom Kaplı
Chrom vanadium, Chrom Plated

| KOD CODE | + | L mm | g | □ | TL/Ad. |
|--------------|------|------|----|----|--------|
| 1107 06 1501 | Ph 1 | 37 | 14 | 10 | |
| 1107 06 1502 | Ph 2 | 37 | 14 | 10 | |
| 1107 06 1503 | Ph 3 | 37 | 15 | 10 | |
| 1107 06 1504 | Ph 4 | 37 | 16 | 10 | |

1107

1/4" Bits Uçlu Lokma Set (42 Parça) Bit Socket Wrench Set (42 Pcs)



1/4"

| KOD CODE | İÇERİK CONTENTS | □ | TL/Ad. |
|--------------|---|----|--------|
| 1107 00 1042 | 1/4" Lokmalı Star Torx® Uçlar Torx® Bit Socket T8-T9-T10-T15-T20-T25-T27-T30-T40 | 42 | |
| | 1/4" Lokmalı Star Delikli Torx® Uçlar Tamper Resistant Torx® Bit Socket Wrench TR8-TR9-TR10-TR15-TR20-TR25-TR27 TR30-TR40 | | |
| | 1/4" Lokmalı Allen Uçlar Hexagonal Bit Socket Wrench 2.5-3-4-5-6-7-8-10 | | |
| | 1/4" Lokmalı Düz Uç Slotted Bit Socket Wrench 3-3.5-4-4.5-5.5 6.5-7-8-10 | | |
| | 1/4" Lokmalı Yıldız Uç Phillips Bit Socket Wrench Ph1-Ph2-Ph3-Ph4 | | |
| | 1/4" Cırcır kolu Ratchet Handle | | |
| | 1/4" Ara Kol Extension Bar 100 mm | | |
| | 1/4" Lokma Tornavida Adaptörü Spindle Handle | | |

1507

1/4" Ara Kol Extension Bar

TS ISO 3316
DIN 3123



1/4"

Krom vanadyum, Krom kaplı, Polisajlı
Chrom vanadium, Chrom plated, Polished

| KOD CODE | L mm | g | □ | TL/Ad. |
|--------------|------|----|---|--------|
| 1507 06 0050 | 50 | 25 | 5 | |
| 1507 06 0100 | 100 | 45 | 5 | |

1507

1/4" Ara Kol Flexible Flexible Extension



1/4"

Krom vanadyum, Krom kaplı
Chrom vanadium, Chrom plated

| KOD CODE | L mm | g | □ | TL/Ad. |
|--------------|------|----|---|--------|
| 1507 06 3150 | 150 | 70 | 5 | |

1507

1/4" Mafsal Universal Joint

TS ISO 1174
DIN 3123



1/4"

Krom vanadyum, Krom kaplı, Polisajlı
Chrom vanadium, Chrom plated, Polished

| KOD CODE | L mm | g | □ | TL/Ad. |
|--------------|------|----|---|--------|
| 1507 06 0038 | 38 | 25 | 5 | |

1507

1/4" T Kol Sliding T - Handle

TS ISO 3315
DIN 3122



1/4"

Krom vanadyum, Krom kaplı, Polisajlı
Chrom vanadium, Chrom plated, Polished

| KOD CODE | L mm | g | □ | TL/Ad. |
|--------------|------|----|---|--------|
| 1507 06 4115 | 115 | 45 | 5 | |

(★) İşaretili olan ürünler stoklarla sınırlıdır.
Limited with stocks.

1507**1/4" Cırcır Kolu**
Ratchet Handle

TS ISO 3315

**1/4"****Krom vanadyum, Krom kaplı, Polisajlı**
Chrom vanadium, Chrom plated, Polished

| KOD CODE | L mm | g | TL/Ad. |
|--------------|------|-----|--------|
| 1507 06 2140 | 140 | 140 | 5 |

1507**1/4" Mandallı Cırcır Kolu**
Ratchet With Latch

TS ISO 3315

**YENİ NEW****1/4"****Krom vanadyum, Krom kaplı, Polisajlı**
Chrom vanadium, Chrom plated, Polished

| KOD CODE | L mm | g | TL/Ad. |
|--------------|------|-----|--------|
| 1507 06 6140 | 140 | 140 | 5 |

1507**1/4" Mafsallı Cırcır Kolu (72 Diş)**
*Swivel Head Ratchet (72 Teeth)***YENİ NEW****1/4"****Krom vanadyum, Krom kaplı, Polisajlı**
Chrom vanadium, Chrom plated, Polished

| KOD CODE | L mm | g | TL/Ad. |
|--------------|------|-----|--------|
| 1507 06 2150 | 150 | 130 | 5 |

1507**1/4" Lokma/Bits Tutuculu Cırcır Kolu (72 Diş)**
*Socket/Bit Holder mini Ratchet (72 Teeth)***YENİ NEW****1/4"****Krom vanadyum, Krom kaplı, Polisajlı**
Chrom vanadium, Chrom plated, Polished

| KOD CODE | L mm | g | TL/Ad. |
|--------------|------|-----|--------|
| 1507 06 2110 | 110 | 100 | 5 |

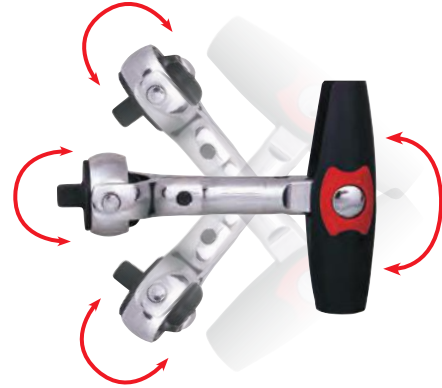
1507**1/4" Mafsallı T Kol Cırcır (72 Diş)**
*Swivel Head, T Handle Ratchet (72 Teeth)***YENİ NEW****1/4"****Krom vanadyum, Krom kaplı, Polisajlı**
Chrom vanadium, Chrom plated, Polished

| KOD CODE | L mm | g | TL/Ad. |
|--------------|------|-----|--------|
| 1507 06 7115 | 115 | 110 | 5 |

1507

1/4" Lokma Adaptörü
Adapter

TS ISO 3316
DIN 3123



1/4"

Krom vanadyum, Krom kaplı, Polişajlı
Chrom vanadium, Chrom plated, Polished

| KOD CODE | inch | g | | TL/Ad. |
|--------------|-------------|----|---|--------|
| 1507 06 0004 | 1/4"Fx3/8"M | 20 | 5 | |

1507

1/4" Derin Lokma Tornavida Adaptörü
Spindle Handle

TS ISO 3315
DIN 3122

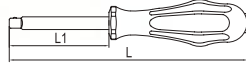

1/4"

Krom vanadyum, Krom kaplı, Polişajlı, Selüloz Asetat Saplı
Chrom vanadium, Chrom plated, Polished, Cellulose Acetate Handle

| KOD CODE | L mm | L1 mm | g | | TL/Ad. |
|--------------|------|-------|-----|----|--------|
| 1507 06 4080 | 150 | 65 | 100 | 10 | |

1107

1/4" Bits Tutucu Lokma (Mıknatıslı)
Bit Holder Socket



1/4"

Krom vanadyum
Chrom vanadium

| KOD CODE | Inch | g | | TL/Ad. |
|--------------|-----------------|----|---|--------|
| 1107 06 5010 | 1/4" F - 1/4" F | 15 | 5 | |

1107

1/4" Altı Köşe Lokma Anahtar Takımı (15 parça, mm)
Socket Wrench Set 6 Points (15 pcs, mm)



1/4"

| KOD CODE | LOKMA LAR Sockets | AVADANLIKLAR Accessories | g | | TL/ Ad. |
|--------------|--|---|-----|----|------------|
| 1107 00 6015 | 4 - 5 - 6 7 - 8 - 9 - 10 11 - 12 - 13 Altı Köşe Six Points | 1/4" Cırcır kolu Ratchet Handle 1/4" Mafsal Universal Joint 1/4" T Kol Sliding T Handle 1/4" Ara Kol Extension Bar 50 mm 1/4" Ara Kol Extension Bar 100 mm | 960 | 15 | |



(★) İşaretili olan ürünler stoklarla sınırlıdır.
Limited with stocks.

Havai aletler ile kullanmayınız / Do not use with power-tools

1110

3/8" Altı Köşe Lokma Anahtar (mm)
Socket Wrench 6 Points (mm)

TS ISO 2725 - 1
DIN 3124

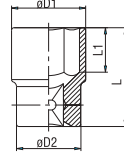

3/8"

Krom vanadyum, Krom kaplı, Polisajlı
Chrom vanadium, Chrom plated, Polished

| KOD CODE | mm | ø D1 mm | ø D2 mm | L mm | L1 mm | g | TL/Ad. |
|--------------|----|---------|---------|------|-------|----|--------|
| 1110 06 0006 | 6 | 9.8 | 17.8 | 27 | 9 | 25 | 10 |
| 1110 06 0007 | 7 | 10.8 | 17.8 | 27 | 9 | 25 | 10 |
| 1110 06 0008 | 8 | 12 | 17.8 | 27 | 9 | 25 | 10 |
| 1110 06 0009 | 9 | 13.2 | 17.8 | 27 | 9 | 25 | 10 |
| 1110 06 0010 | 10 | 14.5 | 17.8 | 27 | 9 | 25 | 10 |
| 1110 06 0011 | 11 | 15.8 | 17.8 | 27 | 9 | 30 | 10 |
| 1110 06 0012 | 12 | 16.8 | 17.8 | 27 | 9 | 30 | 10 |
| 1110 06 0013 | 13 | 17.8 | 16.8 | 27 | 9 | 30 | 10 |
| 1110 06 0014 | 14 | 19.6 | 17.5 | 29 | 11 | 35 | 10 |
| 1110 06 0015 | 15 | 20.8 | 18 | 29 | 11 | 45 | 10 |
| 1110 06 0016 | 16 | 21.8 | 19 | 29 | 11 | 45 | 10 |
| 1110 06 0017 | 17 | 23.4 | 20 | 29 | 11 | 55 | 10 |
| 1110 06 0018 | 18 | 24.7 | 21 | 29 | 13 | 60 | 10 |
| 1110 06 0019 | 19 | 25.8 | 22 | 29 | 13 | 65 | 10 |
| 1110 06 0021 | 21 | 27.8 | 24 | 32 | 13 | 80 | 10 |
| 1110 06 0022 | 22 | 29.7 | 26 | 32 | 15 | 85 | 10 |
| 1110 06 0023 | 23 | 29.7 | 26 | 32 | 15 | 90 | 10 |

1110

3/8" Buji Lokma Anahtar (Lastikli)
Spark Plug Socket with Rubber

TS ISO 2725 - 1



3/8"

Krom vanadyum, Krom kaplı, Polisajlı
Chrom vanadium, Chrom plated, Polished

| KOD CODE | mm | L mm | g | TL/Ad. |
|--------------|----|------|-----|--------|
| 1110 06 9208 | 21 | 70 | 145 | 10 |

1510

3/8" Cırcır Kolu
Ratchet Handle

TS ISO 3315
DIN 3122



3/8"

Krom vanadyum, Krom kaplı, Polisajlı
Chrom vanadium, Chrom plated, Polished

| KOD CODE | L mm | g | TL/Ad. |
|--------------|------|-----|--------|
| 1510 06 0200 | 200 | 295 | 5 |

1510

3/8" Ara Kol
Extension Bar

TS ISO 3316
DIN 3123



3/8"

Krom vanadyum, Krom kaplı, Polisajlı
Chrom vanadium, Chrom plated, Polished

| KOD CODE | L mm | g | TL/Ad. |
|--------------|------|-----|--------|
| 1510 06 0075 | 75 | 75 | 5 |
| 1510 06 0150 | 150 | 145 | 5 |

1510

3/8" Mafsal
Universal Joint

TS ISO 3316
DIN 3123



3/8"

Krom vanadyum, Krom kaplı, Polisajlı
Chrom vanadium, Chrom plated, Polished

| KOD CODE | L mm | g | TL/Ad. |
|--------------|------|----|--------|
| 1510 06 0056 | 56.5 | 60 | 5 |

1510

3/8" T Kol
Sliding T - Handle

TS ISO 3315
DIN 3122



1110

3/8" Altı Köşe Lokma Anahtar Takımı (19 parça, mm)
6 Points Socket Wrench Set (19 Pcs, mm)



3/8"

Krom vanadyum, Krom kaplı, Polisajlı
Chrom vanadium, Chrom plated, Polished

| KOD CODE | L mm | g | TL/Ad. |
|--------------|---------|-----|--------|
| 1510 06 1200 | 200 | 180 | 5 |



3/8"

1510

3/8" Lokma Adaptörü
Adapter

TS ISO 3316
DIN 3123



3/8"

Krom vanadyum, Krom kaplı, Polisajlı
Chrom vanadium, Chrom plated, Polished

| KOD CODE | inch | g | TL/Ad. |
|--------------|-------------|----|--------|
| 1510 06 0007 | 3/8"Fx1/2"M | 45 | 5 |

| KOD CODE | LOKMALAR Sockets | AVADANLIKLAR Accessories | g | TL/Ad. |
|--------------|--|--|------|--------|
| | | 3/8" Cırcır Kolu Ratchet Handle | | |
| | | 3/8" Mafsal Universal Joint | | |
| | 6 - 7 - 8 - 9 10 - 11 - 12 13 - 14 - 17 19 - 21 - 23 | | | |
| | Altı Köşe Six Points | | | |
| 1110 00 6019 | 20,8 | 3/8" T Kol Sliding T Handle | 1089 | 19 |
| | Buji Lokma Lastikli Altı Köşe Spark Plug Socket With Rubber | | | |
| | | 3/8" Ara Kol Extension Bar 75 mm | | |
| | | 3/8" Ara Kol Extension Bar 150 mm | | |

Havali aletler ile kullanmayınız / Do not use with power-tools

1/2" Lokma Anahtar Sehpası (145 Parça) Display Frame for Sockets (145 Pcs)



1/2"

| KOD CODE | İÇERİK CONTENTS | g | TL/Ad. |
|--------------|--|--------|--------|
| | Dolu/Full | | |
| | 10-11-12 13-14-15 16-17-18-19 10 adet /10 Pcs | | |
| 1113 00 6145 | | 18.236 | 1 |
| | 21-22-23 24-26-27 28-30-32 5 Adet / 5 Pcs | | |

1/2" Altı Köşe Lokma Anahtar (mm) Socket Wrench 6 Points (mm)

TS ISO 2725 -1
DIN 3124



1/2"

Krom vanadyum, Krom kaplı
Chrom vanadium, Chrom plated

| KOD CODE | mm | ø D1 mm | ø D2 mm | L mm | L1 mm | g | TL/Ad. |
|--------------|----|---------|---------|------|-------|-----|--------|
| 1113 06 1008 | 8 | 14 | 22 | 38 | 7 | 55 | 10 |
| 1113 06 1009 | 9 | 14.1 | 22 | 38 | 7 | 55 | 10 |
| 1113 06 1010 | 10 | 15.4 | 22 | 38 | 8 | 55 | 10 |
| 1113 06 1011 | 11 | 16.6 | 22 | 38 | 8 | 60 | 10 |
| 1113 06 1012 | 12 | 17.8 | 22 | 38 | 9 | 60 | 10 |
| 1113 06 1013 | 13 | 19 | 22 | 38 | 10 | 65 | 10 |
| 1113 06 1014 | 14 | 20.4 | 22 | 38 | 11 | 65 | 10 |
| 1113 06 1015 | 15 | 21.6 | 22 | 38 | 11 | 65 | 10 |
| 1113 06 1016 | 16 | 22.9 | 22 | 38 | 11 | 70 | 10 |
| 1113 06 1017 | 17 | 24 | 22 | 38 | 12 | 70 | 10 |
| 1113 06 1018 | 18 | 25.4 | 23 | 38 | 13 | 75 | 10 |
| 1113 06 1019 | 19 | 26.6 | 23 | 38 | 13 | 75 | 10 |
| 1113 06 1020 | 20 | 28 | 24 | 38 | 13 | 80 | 10 |
| 1113 06 1021 | 21 | 29.2 | 24 | 38 | 13 | 85 | 5 |
| 1113 06 1022 | 22 | 30.4 | 26 | 38 | 15 | 95 | 5 |
| 1113 06 1023 | 23 | 31.2 | 28 | 38 | 15 | 100 | 5 |
| 1113 06 1024 | 24 | 32.9 | 28 | 38 | 17 | 115 | 5 |
| 1113 06 1025 | 25 | 33.2 | 29 | 42 | 17 | 125 | 5 |
| 1113 06 1026 | 26 | 34 | 30 | 42 | 17 | 135 | 5 |
| 1113 06 1027 | 27 | 36.6 | 30 | 42 | 19 | 140 | 5 |
| 1113 06 1028 | 28 | 37.5 | 30 | 42 | 20 | 160 | 5 |
| 1113 06 1029 | 29 | 39.5 | 32 | 42 | 21 | 170 | 5 |
| 1113 06 1030 | 30 | 40 | 32 | 44 | 21 | 180 | 5 |
| 1113 06 1032 | 32 | 43 | 34 | 44 | 23 | 190 | 5 |



1114

1/2" On İki Köşe Lokma Anahtar (mm) Socket Wrench 12 Points (mm)

TS ISO 2725 - 1
DIN 3124



1/2"

Krom vanadyum, Krom kaplı
Chrom vanadium, Chrom plated

| KOD CODE | Ø mm | Ø D1 mm | Ø D2 mm | L mm | L1 mm | g | TL/Ad. |
|--------------|------|---------|---------|------|-------|-----|--------|
| 1114 06 1010 | 10 | 15 | 23.3 | 38 | 8 | 60 | 10 |
| 1114 06 1011 | 11 | 16.4 | 23.3 | 38 | 8 | 60 | 10 |
| 1114 06 1012 | 12 | 17.8 | 23.3 | 38 | 9 | 60 | 10 |
| 1114 06 1013 | 13 | 19 | 23.3 | 38 | 10 | 60 | 10 |
| 1114 06 1014 | 14 | 20.4 | 23.3 | 38 | 11 | 60 | 10 |
| 1114 06 1015 | 15 | 21.6 | 23.3 | 38 | 11 | 65 | 10 |
| 1114 06 1016 | 16 | 22.9 | 24 | 38 | 11 | 70 | 10 |
| 1114 06 1017 | 17 | 24 | 22.5 | 38 | 12 | 70 | 10 |
| 1114 06 1018 | 18 | 25.2 | 23 | 38 | 13 | 70 | 10 |
| 1114 06 1019 | 19 | 26.8 | 23 | 38 | 13 | 75 | 10 |
| 1114 06 1020 | 20 | 28 | 23 | 38 | 13 | 80 | 10 |
| 1114 06 1021 | 21 | 29.2 | 23 | 38 | 13 | 80 | 5 |
| 1114 06 1022 | 22 | 30.2 | 24 | 40 | 15 | 95 | 5 |
| 1114 06 1023 | 23 | 31.4 | 25 | 40 | 15 | 100 | 5 |
| 1114 06 1024 | 24 | 32.6 | 26 | 42 | 17 | 105 | 5 |
| 1114 06 1026 | 26 | 35.3 | 28 | 42 | 17 | 135 | 5 |
| 1114 06 1027 | 27 | 36.6 | 28 | 42 | 19 | 135 | 5 |
| 1114 06 1028 | 28 | 37.8 | 30 | 42 | 20 | 155 | 5 |
| 1114 06 1030 | 30 | 40 | 30 | 44 | 21 | 165 | 5 |
| 1114 06 1032 | 32 | 42.5 | 30 | 44 | 23 | 180 | 5 |



Havali aletler ile kullanmayınız / Do not use with power-tools

1413

1/2" On İki Köşe Lokma Anahtar (SAE) Socket Wrench 12 Points (SAE)



1/2"

Krom vanadyum, Krom kaplı
Chrom vanadium, Chrom plated

| KOD CODE | Ø inch | Ø D1 mm | Ø D2 mm | L mm | L1 mm | g | TL/Ad. |
|--------------|---------|---------|---------|------|-------|-----|--------|
| 1413 06 1008 | 5/16" | 13.2 | 21.8 | 37 | 6 | 45 | 10 |
| 1413 06 1095 | 3/8" | 15 | 21.8 | 37 | 8 | 50 | 10 |
| 1413 06 1010 | 7/16" | 16.4 | 23.3 | 37 | 9 | 60 | 10 |
| 1413 06 1011 | 15/32" | 18 | 23.3 | 37 | 9 | 60 | 10 |
| 1413 06 1012 | 1/2" | 19 | 23.3 | 37 | 9 | 60 | 10 |
| 1413 06 1013 | 9/16" | 20.4 | 23.3 | 37 | 11 | 60 | 10 |
| 1413 06 1014 | 19/32" | 21.6 | 23.3 | 37 | 11 | 65 | 10 |
| 1413 06 1015 | 5/8" | 23.1 | 22 | 38 | 11 | 70 | 10 |
| 1413 06 1016 | 11/16" | 24.5 | 22.5 | 38 | 11 | 70 | 10 |
| 1413 06 1017 | 3/4" | 26.8 | 23 | 38 | 13 | 75 | 10 |
| 1413 06 1020 | 25/32" | 28 | 23 | 38 | 13 | 75 | 10 |
| 1413 06 1021 | 13/16" | 28.6 | 23 | 38 | 13 | 80 | 10 |
| 1413 06 1022 | 7/8" | 30.2 | 24 | 40 | 15 | 90 | 5 |
| 1413 06 1024 | 15/16" | 32.6 | 26 | 42 | 17 | 115 | 5 |
| 1413 06 1025 | 1" | 35 | 28 | 42 | 17 | 130 | 5 |
| 1413 06 1027 | 1 1/16" | 36.6 | 28 | 42 | 19 | 135 | 5 |
| 1413 06 1029 | 1 1/8" | 38.8 | 30 | 42 | 19 | 170 | 5 |
| 1413 06 1030 | 1 3/16" | 40 | 29.5 | 44 | 20 | 170 | 5 |
| 1413 06 1032 | 1 1/4" | 42.5 | 30 | 44 | 22 | 185 | 5 |

1113

1/2" Buji Lokma Anahtar (Lastikli) Spark Plug Socket with Rubber



1/2"

Krom vanadyum, Krom kaplı, Polished
Chrom vanadium, Chrom plated, Polished

| KOD CODE | Ø mm | L mm | g | TL/Ad. |
|--------------|------|------|-----|--------|
| 1113 06 9160 | 16 | 70 | 80 | 10 |
| 1113 06 9208 | 21 | 70 | 155 | 10 |

(★) İşaretili olan ürünler stoklarla sınırlıdır.
Limited with stocks.

1108

1/2" Altı Köşe Derin Lokma Anahtar (mm)
Deep Socket Wrench 6 Points (mm)

TS ISO 2725 - 1
DIN 3124



1/2"

Krom vanadyum, Krom kaplı
Chrom vanadium, Chrom plated

| KOD CODE | mm | ØD1 mm | ØD2 mm | L mm | L1 mm | g | TL/Ad. |
|--------------|----|--------|--------|------|-------|-----|--------|
| 1108 06 0010 | 10 | 15,2 | 22 | 75 | 6 | 110 | 10 |
| 1108 06 0011 | 11 | 16,7 | 24 | 75 | 7 | 110 | 10 |
| 1108 06 0012 | 12 | 18 | 24 | 75 | 8 | 110 | 10 |
| 1108 06 0013 | 13 | 19 | 24 | 75 | 8 | 120 | 10 |
| 1108 06 0014 | 14 | 20,5 | 24 | 75 | 10 | 120 | 10 |
| 1108 06 0015 | 15 | 21,7 | 24 | 75 | 10 | 140 | 10 |
| 1108 06 0016 | 16 | 22 | 25,5 | 75 | 10 | 140 | 10 |
| 1108 06 0017 | 17 | 24 | 25,5 | 75 | 10 | 140 | 10 |
| 1108 06 0018 | 18 | 25,5 | 25,5 | 75 | 12 | 150 | 10 |
| 1108 06 0019 | 19 | 26 | 26,7 | 75 | 12 | 150 | 10 |

1108

1/2" Altı Köşe Derin Lokma Anahtar Takımı (10 parça mm)
Deep Socket Set (10 pcs. mm)



1/2"

| KOD CODE | İÇERİK CONTENTS | g | TL/Ad. |
|--------------|----------------------------------|------|--------|
| 1108 00 6010 | 10-11-12-13-14-15 16-17-18-19 | 1290 | 10 |

1113

1/2" Star (Torx®) Lokma Anahtar
Star Torx® Socket Wrench



1/2"

Krom vanadyum, Krom kaplı
Chrom vanadium, Chrom plated

| KOD CODE | mm | Ø D1 mm | Ø D2 mm | L mm | L1 mm | g | TL/Ad. |
|--------------|-----|---------|---------|------|-------|----|--------|
| 1113 06 0210 | E10 | 13.2 | 23.8 | 37 | 7.5 | 60 | 10 |
| 1113 06 0212 | E12 | 15 | 23.8 | 37 | 9 | 65 | 10 |
| 1113 06 0214 | E14 | 16.4 | 23.8 | 37 | 10 | 65 | 10 |
| 1113 06 0216 | E16 | 18.8 | 23.8 | 37 | 11 | 70 | 10 |
| 1113 06 0218 | E18 | 20.5 | 23.8 | 39 | 12.5 | 75 | 10 |
| 1113 06 0220 | E20 | 23 | 23.8 | 39 | 14 | 75 | 10 |

1113

1/2" Star (Torx®) Lokma Anahtar Takımı (7 Parça)
Star Torx® Socket Wrench Set (7 Pcs)



1/2"

| KOD CODE | İÇERİK CONTENTS | g | TL/Ad. |
|--------------|---|------|--------|
| 1113 00 6007 | Star Lokma / Star Socket E10 - E12 - E14 - E16 - E18 - E20 125 mm Ara Kol / Extension Bar | 1075 | 7 |

1113

1/2" Lokmalı Allen Uç Hexagonal Bit Socket Wrench



1/2"

Krom vanadyum, Krom kaplı
Chrom vanadium, Chrom plated

| KOD CODE | mm | L mm | g | TL/Ad. |
|--------------|----|------|-----|--------|
| 1113 06 1105 | 5 | 60 | 70 | 10 |
| 1113 06 1106 | 6 | 60 | 70 | 10 |
| 1113 06 1107 | 7 | 60 | 75 | 10 |
| 1113 06 1108 | 8 | 60 | 75 | 10 |
| 1113 06 1110 | 10 | 60 | 85 | 10 |
| 1113 06 1112 | 12 | 60 | 100 | 10 |
| 1113 06 1114 | 14 | 60 | 115 | 10 |
| 1113 06 4105 | 5 | 100 | 90 | 10 |
| 1113 06 4106 | 6 | 100 | 90 | 10 |
| 1113 06 4107 | 7 | 100 | 90 | 10 |
| 1113 06 4108 | 8 | 100 | 95 | 10 |
| 1113 06 4110 | 10 | 100 | 105 | 10 |
| 1113 06 4112 | 12 | 100 | 145 | 10 |
| 1113 06 4114 | 14 | 100 | 155 | 10 |
| 1113 06 4117 | 17 | 100 | 200 | 10 |

1113

1/2" Lokmalı Star (Torx®) Uç Star (Torx) Bit Socket Wrench



1/2"

Krom vanadyum, Krom kaplı
Chrom vanadium, Chrom plated

| KOD CODE | ☆ | L mm | g | TL/Ad. |
|--------------|-----|------|-----|--------|
| 1113 06 1220 | T20 | 60 | 70 | 10 |
| 1113 06 1225 | T25 | 60 | 70 | 10 |
| 1113 06 1227 | T27 | 60 | 70 | 10 |
| 1113 06 1230 | T30 | 60 | 70 | 10 |
| 1113 06 1240 | T40 | 60 | 70 | 10 |
| 1113 06 1245 | T45 | 60 | 70 | 10 |
| 1113 06 1250 | T50 | 60 | 75 | 10 |
| 1113 06 1255 | T55 | 60 | 80 | 10 |
| 1113 06 1260 | T60 | 60 | 100 | 10 |
| 1113 06 4220 | T20 | 100 | 78 | 10 |
| 1113 06 4225 | T25 | 100 | 79 | 10 |
| 1113 06 4227 | T27 | 100 | 80 | 10 |
| 1113 06 4230 | T30 | 100 | 80 | 10 |
| 1113 06 4240 | T40 | 100 | 80 | 10 |
| 1113 06 4245 | T45 | 100 | 82 | 10 |
| 1113 06 4250 | T50 | 100 | 82 | 10 |
| 1113 06 4255 | T55 | 100 | 100 | 10 |
| 1113 06 4260 | T60 | 100 | 134 | 10 |

1113

1/2" Lokmalı Allen Uç Takımı (60 mm, 7 Parça) Hexagonal Bits Socket Wrench Set (60 mm, 7 Pcs)



1/2"

| KOD CODE | İÇERİK CONTENTS | g | TL/Ad. |
|--------------|---|------|--------|
| 1113 00 1107 | Allen Uçlar 60mm Hex Bit Socket 5-6-7-8-10-12-14 | 1040 | 7 |

1113

1/2" Lokmalı Torx® Uç Takımı (60 mm, 9 parça) Torx® Bits Socket Wrench Set (60 mm, 9 Pcs)



1/2"

| KOD CODE | İÇERİK CONTENTS | g | TL/Ad. |
|--------------|---|------|--------|
| 1113 00 6009 | Torx® Uçlar 60mm Star Socket T20 - T25 - T27 - T30 - T40 - T45 T50 - T55 - T60 | 1125 | 9 |

Havali aletler ile kullanmayınız / Do not use with power-tools

1/2" Lokmalı Allen Uç ve Star (Torx)® Uç Takımı (17 Parça)
Hex Bit Sockets - Torx Bit Sockets Set (17 Pcs)



1/2"

| KOD CODE | İÇERİK CONTENTS | g | TL/Ad. |
|--------------|---|----|--------|
| 1113 00 6017 | <p>T Kol (1/2") Sliding T Handle</p> <p>5 - 6 - 7 - 8 - 10 - 12 - 14</p> <p>Lokmalı Allen Uç 60mm Hex Bit Socket</p> <p>T20 - T25 - T27 T30 - T40</p> <p>Lokmalı Star (Torx) Uç 60mm Torx Bit Socket</p> | 17 | |



Havali aletler ile kullanmayınız / Do not use with power-tools

1/2" On İki Köşe Lokmalı Bits Uç Yivli (XZN)
Hex Bit Socket 12 Points (XZN)



1/2"

Krom vanadyum, Krom kaplı
Chrom vanadium, Chrom plated

| KOD CODE | | L mm | g | TL/Ad. |
|--------------|-----|------|-----|--------|
| 1114 06 4005 | M5 | 60 | 60 | 10 |
| 1114 06 4006 | M6 | 60 | 62 | 10 |
| 1114 06 4008 | M8 | 60 | 62 | 10 |
| 1114 06 4010 | M10 | 60 | 78 | 10 |
| 1114 06 4012 | M12 | 60 | 84 | 10 |
| 1114 06 4106 | M6 | 80 | 69 | 10 |
| 1114 06 4108 | M8 | 80 | 70 | 10 |
| 1114 06 4110 | M10 | 80 | 84 | 10 |
| 1114 06 4112 | M12 | 80 | 103 | 10 |
| 1114 06 4114 | M14 | 80 | 133 | 10 |
| 1114 06 4208 | M8 | 140 | 96 | 10 |
| 1114 06 4210 | M10 | 140 | 125 | 10 |
| 1114 06 4212 | M12 | 140 | 161 | 10 |
| 1114 06 4214 | M14 | 140 | 210 | 10 |
| 1114 06 4216 | M16 | 140 | 281 | 10 |

1/2" Lokmalı (Ribe) Bits Uç
Socket Wrench 6 Points



1/2"

Krom vanadyum, Krom kaplı
Chrom vanadium, Chrom plated

| KOD CODE | | L mm | g | TL/Ad. |
|--------------|------|------|-----|--------|
| 1114 06 5004 | 4 | 100 | 75 | 10 |
| 1114 06 5005 | 5 | 100 | 76 | 10 |
| 1114 06 5006 | 6 | 100 | 76 | 10 |
| 1114 06 5007 | 7 | 100 | 77 | 10 |
| 1114 06 5008 | 8 | 100 | 78 | 10 |
| 1114 06 5009 | 9 | 100 | 85 | 10 |
| 1114 06 5010 | 10 | 100 | 96 | 10 |
| 1114 06 5011 | 10.5 | 100 | 96 | 10 |
| 1114 06 5012 | 12 | 100 | 121 | 10 |
| 1114 06 5013 | 13 | 100 | 148 | 10 |
| 1114 06 5014 | 14 | 100 | 150 | 10 |
| 1114 06 5016 | 16 | 100 | 198 | 10 |

(★) İşaretili olan ürünler stoklarla sınırlıdır.
Limited with stocks.

1513

1/2" Cırcır Kolu (32 Diş)
Ratchet Handle

TS ISO 3315
DIN3122



1/2"

Krom vanadyum, Krom kaplı
Chrom vanadium, Chrom plated

| KOD CODE | L mm | g | | TL/Ad. |
|--------------|------|-----|---|--------|
| 1513 06 0032 | 250 | 580 | 5 | |

1513

1/2" Ara Kol
Extension Bar

TS ISO 3316
DIN 3123



1/2"

Krom vanadyum, Krom kaplı
Chrom vanadium, Chrom plated

| KOD CODE | L mm | g | | TL/Ad. |
|--------------|------|-----|---|--------|
| 1513 06 4075 | 75 | 140 | 5 | |
| 1513 06 4125 | 125 | 215 | 5 | |
| 1513 06 4250 | 250 | 420 | 5 | |

1513

1/2" T Kol Adaptörü
Adapter



1/2"

Krom vanadyum, Krom kaplı
Chrom vanadium, Chrom plated

| KOD CODE | inch | g | | TL/Ad. |
|--------------|-------------|----|---|--------|
| 1513 06 5250 | 3/8"Fx1/2"M | 90 | 5 | |

1513

1/2" T Kol
Sliding T - Handle

TS ISO 3315
DIN 3122



1/2"

Krom vanadyum, Krom kaplı
Chrom vanadium, Chrom plated

| KOD CODE | L mm | g | | TL/Ad. |
|--------------|------|-----|---|--------|
| 1513 06 2250 | 250 | 355 | 5 | |

1513

1/2" Mafsal
Universal Joint

TS ISO 3316
DIN 3123



1/2"

Krom vanadyum, Krom kaplı
Chrom vanadium, Chrom plated

| KOD CODE | L mm | g | | TL/Ad. |
|--------------|------|-----|---|--------|
| 1513 06 4070 | 70 | 140 | 5 | |

1513

1/2" Lokma Adaptörü
Adapter

TS ISO 3316
DIN 3123



1/2"

Krom vanadyum, Krom kaplı
Chrom vanadium, Chrom plated

| KOD CODE | inch | g | | TL/Ad. |
|--------------|-------------|-----|---|--------|
| 1513 06 0002 | 1/2"Fx3/8"M | 55 | 5 | |
| 1513 06 0003 | 1/2"Fx3/4"M | 115 | 5 | |

1113

1/2" Bits Tutucu Lokma
Bit Holder Scket



1/2"

Krom vanadyum, Krom kaplı
Chrom vanadium, Chrom plated

| KOD CODE | Inch | g | | TL/Ad. |
|--------------|-----------------|----|---|--------|
| 1113 06 5010 | 1/2" F - 1/4" F | 50 | 5 | |

Havali aletler ile kullanmayınız / Do not use with power-tools

1/4" - 1/2" Altı Köşe Lokma Anahtar Takımı (35 Parça)
Socket Wrench Set 6 Point 1/4" - 1/2" (35 Pcs)



| KOD CODE | LOKMALAR Sockets | AVADANLIKLAR Accessories | g | | TL/Ad. |
|--------------|---|---|------|----|--------|
| 1113 00 1038 | 4 - 5 - 6 7 - 8 - 9 - 10 11 - 12 - 13 Altı Köşe Six Points | 1/4" Cırcır kolu Ratchet Handle 1/4" Mafsal Universal Joint 1/4" T Kol Sliding T Handle 1/4" Ara Kol Extension Bar 50 mm 1/4" Ara Kol Extension Bar 100 mm 1/2" Cırcır Kolu Ratchet Handle 1/2" T Kol Adaptör Sliding T Handle Adapter 1/2" Ara Kol Extension Bar 75 mm 1/2" Ara Kol Extension Bar 250 mm | 4000 | 35 | |

1113

1/2" Altı Köşe Lokma Anahtar Takımı (17 Parça, mm)
Socket Wrench Set 6 Points (17 pcs, mm)



1/2"

| KOD CODE | LOKMLAR Sockets | AVADANLIKLAR Accessories | g | TL/Ad. |
|--------------|--|--|------|--------|
| 1113 00 2017 | 10 - 11 - 12 13 - 14 - 15 17 - 19 - 22 24 - 27 - 30 32 | 1/2" Cırcır Kolu Ratchet Handle 1/2" T Kol Adaptör Sliding T Handle Adapter 1/2" Mafsal Universal Joint 1/2" Ara Kol Extension Bar 250 mm | 2880 | 17 |

1113

1/2" Altı Köşe Lokma Anahtar Takımı (24 Parça, mm)
Socket Wrench Set 6 Points (24 pcs, mm)



1/2"

| KOD CODE | LOKMLAR Sockets | AVADANLIKLAR Accessories | g | TL/Ad. |
|--------------|--|--|------|--------|
| 1113 00 2024 | 10 - 11 - 12 13 - 14 - 15 16 - 17 - 18 19 - 21 - 22 23 - 24 - 26 27 - 28 - 30 32 | 1/2" Cırcır Kolu Ratchet Handle 1/2" Mafsal Universal Joint 1/2" T Kol Adaptör Sliding T Handle Adapter 1/2" Ara Kol Extension Bar 125 mm 1/2" Ara Kol Extension Bar 250 mm | 3650 | 24 |

1114

1/2" On İki Köşe Lokma Anahtar Takımı (24 Parça, mm)
Socket Wrench Set 12 Points (24 pcs, mm)



1/2"

| KOD CODE | LOKMLAR Sockets | AVADANLIKLAR Accessories | g | TL/Ad. |
|--------------|--|--|------|--------|
| 1114 00 6024 | 10 - 11 - 12 13 - 14 - 15 16 - 17 - 18 19 - 21 - 22 23 - 24 - 26 27 - 28 - 30 32 | 1/2" Cırcır Kolu Ratchet Handle 1/2" Mafsal Universal Joint 1/2" T Kol Adaptör Sliding T Handle Adapter 1/2" Ara Kol Extension Bar 125 mm 1/2" Ara Kol Extension Bar 250 mm | 4150 | 24 |

1413

1/2" On İki Köşe Lokma Anahtar Takımı (24 parça, SAE)
Socket Wrench Set 12 Points (24 pcs, SAE)



1/2"

| KOD CODE | LOKMLAR Sockets | AVADANLIKLAR Accessories | g | TL/Ad. |
|--------------|---|--|------|--------|
| 1413 00 6024 | 5/16" - 3/8" 7/16" - 15/32" 1/2" - 9/16" 19/32" - 5/8" 11/16" - 3/4" 25/32" - 13/16" 7/8" - 15/16" 1" - 1 1/16" 1 1/8" - 1 3/16" 1 1/4" | 1/2" Cırcır Kolu Ratchet Handle 1/2" Mafsal Universal Joint 1/2" T Kol Adaptör Sliding T Handle Adapter 1/2" Ara Kol Extension Bar 125 mm 1/2" Ara Kol Extension Bar 250 mm | 4150 | 24 |



1119

3/4" Altı Köşe Lokma Anahtar (mm) Socket Wrench 6 Points (mm)

TS ISO 2725 - 1
DIN 3124

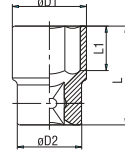

3/4"

Krom vanadyum, Krom kaplı
Chrom vanadium, Chrom plated

| KOD CODE | mm | Ø D1 mm | Ø D2 mm | L mm | L1 mm | g | TL/Ad. |
|--------------|----|---------|---------|------|-------|------|--------|
| 1119 06 1022 | 22 | 33 | 36 | 52 | 16 | 225 | 5 |
| 1119 06 1024 | 24 | 35 | 36 | 52 | 16 | 230 | 5 |
| 1119 06 1027 | 27 | 38 | 36 | 52 | 19 | 235 | 5 |
| 1119 06 1030 | 30 | 42 | 38 | 54 | 21 | 300 | 5 |
| 1119 06 1032 | 32 | 44 | 38 | 56 | 23 | 320 | 5 |
| 1119 06 1034 | 34 | 47 | 42 | 58 | 24 | 400 | 5 |
| 1119 06 1036 | 36 | 50 | 42 | 58 | 25 | 440 | 5 |
| 1119 06 1038 | 38 | 52 | 45 | 60 | 27 | 500 | 5 |
| 1119 06 1041 | 41 | 56 | 45 | 64 | 29 | 580 | 1 |
| 1119 06 1046 | 46 | 62 | 48 | 68 | 33 | 730 | 1 |
| 1119 06 1050 | 50 | 68 | 48 | 72 | 34 | 885 | 1 |
| 1119 06 1055 | 55 | 74 | 48 | 76 | 37 | 1070 | 1 |
| 1119 06 1060 | 60 | 80 | 48 | 78 | 38 | 1170 | 1 |

1120

3/4" On İki Köşe Lokma Anahtar (mm) Socket Wrench 12 Points (mm)

TS ISO 2725 - 1
DIN 3124

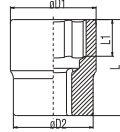

3/4"

Krom vanadyum, Krom kaplı
Chrom vanadium, Chrom plated

| KOD CODE | mm | Ø D1 mm | Ø D2 mm | L mm | L1 mm | g | TL/Ad. |
|--------------|----|---------|---------|------|-------|-----|--------|
| 1120 06 1022 | 22 | 33 | 36 | 52 | 16 | 220 | 5 |
| 1120 06 1024 | 24 | 35 | 36 | 52 | 17 | 225 | 5 |
| 1120 06 1027 | 27 | 38 | 36 | 52 | 19 | 225 | 5 |
| 1120 06 1030 | 30 | 42 | 38 | 54 | 21 | 285 | 5 |
| 1120 06 1032 | 32 | 44 | 38 | 56 | 23 | 310 | 5 |
| 1120 06 1034 | 34 | 47 | 42 | 57 | 24 | 385 | 5 |
| 1120 06 1036 | 36 | 50 | 42 | 58 | 25 | 435 | 5 |
| 1120 06 1041 | 41 | 56 | 45 | 64 | 29 | 560 | 1 |
| 1120 06 1046 | 46 | 62 | 47 | 68 | 34 | 685 | 1 |
| 1120 06 1050 | 50 | 68 | 48 | 72 | 34 | 840 | 1 |

Havali aletler ile kullanmayınız / Do not use with power-tools

1419

3/4" On İki Köşe Lokma Anahtar (SAE) Socket Wrench 12 Points (SAE)

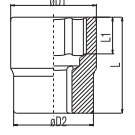

3/4"

Krom vanadyum, Krom kaplı
Chrom vanadium, Chrom plated

| KOD CODE | inch | Ø D1 mm | Ø D2 mm | L mm | L1 mm | g | TL/Ad. |
|--------------|----------|---------|---------|------|-------|-----|--------|
| 1419 06 1022 | 7/8" | 33 | 36 | 52 | 16 | 220 | 5 |
| 1419 06 1024 | 15/16" | 35 | 36 | 52 | 16 | 220 | 5 |
| 1419 06 1025 | 1" | 35 | 36 | 52 | 17 | 220 | 5 |
| 1419 06 1027 | 1 1/16" | 38 | 36 | 52 | 19 | 225 | 5 |
| 1419 06 1028 | 1 1/8" | 40 | 38 | 52 | 19 | 225 | 5 |
| 1419 06 1032 | 1 1/4" | 44 | 38 | 56 | 23 | 315 | 5 |
| 1419 06 1033 | 1 5/16" | 46 | 38 | 56 | 23 | 355 | 5 |
| 1419 06 1035 | 1 3/8" | 48 | 42 | 58 | 25 | 400 | 5 |
| 1419 06 1036 | 1 7/16" | 50 | 42 | 58 | 25 | 425 | 5 |
| 1419 06 1038 | 1 1/2" | 52 | 45 | 60 | 27 | 475 | 5 |
| 1419 06 1041 | 1 5/8" | 56 | 45 | 64 | 29 | 555 | 1 |
| 1419 06 1044 | 1 3/4" | 60 | 47 | 66 | 31 | 660 | 1 |
| 1419 06 1046 | 1 13/16" | 62 | 47 | 68 | 34 | 685 | 1 |
| 1419 06 1047 | 1 7/8" | 64 | 48 | 70 | 34 | 730 | 1 |
| 1419 06 1050 | 2" | 68 | 48 | 72 | 34 | 805 | 1 |

1519

3/4" Cırcır Kolu Ratchet Handle

TS ISO 3315
DIN 3122



3/4"

Krom vanadyum, Krom kaplı
Chrom vanadium, Chrom plated

| KOD CODE | L mm | g | TL/Ad. |
|--------------|------|------|--------|
| 1519 06 4510 | 510 | 2230 | 5 |

1519

3/4" Ara Kol Extension Bar

TS ISO 3316
DIN 3123



3/4"

Krom vanadyum, Krom kaplı
Chrom vanadium, Chrom plated

| KOD CODE | L mm | g | TL/Ad. |
|--------------|------|------|--------|
| 1519 06 4200 | 200 | 730 | 5 |
| 1519 06 4400 | 400 | 1370 | 5 |

(*) İşaretili olan ürünler stoklarla sınırlıdır.
Limited with stocks.

1519

3/4" T Kol
Sliding T - Handle

TS ISO 3315
DIN 3122



3/4"

Krom vanadyum, Krom kaplı
Chrom vanadium, Chrom plated

| KOD CODE | L mm | g | | TL/Ad. |
|--------------|------|------|---|--------|
| 1519 06 4500 | 500 | 1485 | 5 | |

1519

3/4" Lokma Adaptörü
Adapter

TS ISO 3316
DIN 3123



3/4"

Krom vanadyum, Krom kaplı
Chrom vanadium, Chrom plated

| KOD CODE | inch | g | | TL/Ad. |
|--------------|-------------|-----|---|--------|
| 1519 06 0008 | 3/4"Fx1/2"M | 140 | 5 | |
| 1519 06 0001 | 3/4"Fx1"M | 300 | 5 | |

1119

3/4" Altı Köşe Lokma Anahtar Takımı (14 parça, mm)
Socket Wrench Set 6 Points (14 pcs, mm)



3/4"

| KOD CODE | LOKMALAR Sockets | AVADANLIKLAR Accessories | g | | TL/Ad. |
|--------------|--|---|-------|----|--------|
| 1119 00 6114 | | 3/4" Cırcır Kolu Ratchet Handle | 10180 | 14 | |
| | | 3/4" T Kol Sliding T Handle | | | |
| | 22 - 24 - 27 30 - 32 - 34 36 - 41 - 46 50 | 3/4" Ara Kol Extension Bar 200 mm | | | |
| | | 3/4" Ara Kol Extension Bar 400 mm | | | |

1120

3/4" On İki Köşe Lokma Anahtar Takımı (14 parça, mm)
Socket Wrench Set 12 Points (14 pcs, mm)



3/4"

| KOD CODE | LOKMALAR Sockets | AVADANLIKLAR Accessories | g | | TL/Ad. |
|--------------|--|---|-------|----|--------|
| 1120 00 6014 | | 3/4" Cırcır Kolu Ratchet Handle | 13700 | 14 | |
| | | 3/4" T Kol Sliding T Handle | | | |
| | 22 - 24 - 27 30 - 32 - 34 36 - 41 - 46 50 | 3/4" Ara Kol Extension Bar 200 mm | | | |
| | | 3/4" Ara Kol Extension Bar 400 mm | | | |

1419

3/4" On İki Köşe Lokma Anahtar Takımı (14 parça, SAE)
Socket Wrench Set 12 Points (14 pcs, SAE)



3/4"

| KOD CODE | LOKMALAR Sockets | AVADANLIKLAR Accessories | g | | TL/Ad. |
|--------------|--|---|-------|----|--------|
| 1419 00 6114 | | 3/4" Cırcır Kolu Ratchet Handle | 10180 | 14 | |
| | | 3/4" T Kol Sliding T Handle | | | |
| | 15/16" - 1 1/16" 1 1/8" - 1 1/4" 1 5/16" 1 3/8" 1 1/2" - 1 5/8" 1 7/8" - 2" | 3/4" Ara Kol Extension Bar 200 mm | | | |
| | | 3/4" Ara Kol Extension Bar 400 mm | | | |

1225

1" On İki Köşe Lokma Anahtar (mm)
Socket Wrench 12 Points (mm)

TS ISO 2727-1
DIN 3124

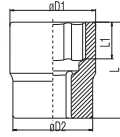

1"

Krom vanadyum, Krom kaplı
Chrom vanadium, Chrom plated

| KOD CODE | Ø mm | Ø D1 mm | Ø D2 mm | L mm | L1 mm | g | TL/Ad. |
|--------------|------|---------|---------|------|-------|------|--------|
| 1225 06 0036 | 36 | 52 | 48 | 65 | 26 | 525 | 1 |
| 1225 06 0041 | 41 | 58 | 50 | 70 | 29 | 665 | 1 |
| 1225 06 0046 | 46 | 65 | 54 | 75 | 32 | 900 | 1 |
| 1225 06 0050 | 50 | 70 | 57 | 75 | 34 | 1040 | 1 |
| 1225 06 0055 | 55 | 76 | 57 | 83 | 42 | 1250 | 1 |
| 1225 06 0060 | 60 | 82 | 60 | 87 | 46 | 1505 | 1 |

1525

1" Lokma Adaptörü
Adapter

TS ISO 3316
DIN 3123



1"

Krom vanadyum, Krom kaplı
Chrom vanadium, Chrom plated

| KOD CODE | inch | g | TL/Ad. |
|--------------|-----------|-----|--------|
| 1525 06 0005 | 1"Fx3/4"M | 330 | 5 |

1113

1/2" Alaşımli Jant Lokma Takımı (3 Parça, mm)
Combination Lug Nut Socket Set (3 Pcs, mm)



1/2"

| KOD CODE | LOKMALAR Sockets | g | TL/Ad. |
|--------------|------------------|-----|--------|
| 1113 00 9003 | 17 -19 - 21 | 800 | 3 |



(*) İşaretili olan ürünler stoklarla sınırlıdır.
Limited with stocks.

1/2" Altı Köşe Havalı Lokma Anahtar (mm)
Impact Socket Wrench 6 Points (mm)

TS ISO 2725-2



IZELTAS YOUTUBE



1/2"

Krom molibden, Fosfat kaplamalı
Chrom molybdenum, Phosphate finish

| KOD CODE | Ø mm | Ø D1 mm | Ø D2 mm | L mm | L1 mm | g | TL/Ad. |
|--------------|------|---------|---------|------|-------|-----|--------|
| 1113 06 7010 | 10 | 17 | 25 | 38 | 8 | 70 | 10 |
| 1113 06 7011 | 11 | 18 | 25 | 38 | 8 | 70 | 10 |
| 1113 06 7012 | 12 | 19 | 25 | 38 | 9 | 70 | 10 |
| 1113 06 7013 | 13 | 20 | 25 | 38 | 10 | 70 | 10 |
| 1113 06 7014 | 14 | 22 | 25 | 38 | 10 | 75 | 10 |
| 1113 06 7015 | 15 | 23 | 30 | 38 | 11 | 110 | 10 |
| 1113 06 7016 | 16 | 24 | 30 | 38 | 11 | 110 | 10 |
| 1113 06 7017 | 17 | 26 | 30 | 38 | 12 | 115 | 10 |
| 1113 06 7018 | 18 | 27 | 30 | 38 | 13 | 115 | 10 |
| 1113 06 7019 | 19 | 28 | 30 | 38 | 13 | 120 | 10 |
| 1113 06 7021 | 21 | 30 | 30 | 40 | 14 | 125 | 5 |
| 1113 06 7022 | 22 | 32 | 30 | 40 | 14 | 145 | 5 |
| 1113 06 7024 | 24 | 34 | 30 | 42 | 15 | 150 | 5 |
| 1113 06 7027 | 27 | 38 | 30 | 44 | 16 | 175 | 5 |

1513

1/2" Havalı Lokma Ara Kol
Impact Socket Extension Bar



1/2"

Krom molibden, Fosfat kaplamalı
Chrom molybdenum, Phosphate finish

| KOD CODE | L mm | g | TL/Ad. |
|--------------|------|-----|--------|
| 1513 06 7125 | 125 | 275 | 5 |

1108

1/2" Altı Köşe Havalı Derin Lokma Anahtar (mm)
6 Point Impact Socket Wrench, Long Type (mm)



1/2"



Krom molibden, Fosfat kaplamalı
Chrom molybdenum, Phosphate finish

| KOD CODE | Ø mm | L mm | g | TL/Ad. |
|--------------|------|------|-----|--------|
| 1108 06 7010 | 10 | 80 | 136 | 10 |
| 1108 06 7011 | 11 | 80 | 144 | 10 |
| 1108 06 7012 | 12 | 80 | 157 | 10 |
| 1108 06 7013 | 13 | 80 | 157 | 10 |
| 1108 06 7014 | 14 | 80 | 172 | 10 |
| 1108 06 7015 | 15 | 80 | 223 | 10 |
| 1108 06 7016 | 16 | 80 | 230 | 10 |
| 1108 06 7017 | 17 | 80 | 240 | 10 |
| 1108 06 7018 | 18 | 80 | 255 | 10 |
| 1108 06 7019 | 19 | 80 | 236 | 10 |
| 1108 06 7021 | 21 | 80 | 240 | 10 |
| 1108 06 7022 | 22 | 80 | 296 | 5 |
| 1108 06 7024 | 24 | 80 | 308 | 5 |
| 1108 06 7027 | 27 | 80 | 356 | 5 |
| 1108 06 7030 | 30 | 80 | 416 | 5 |
| 1108 06 7032 | 32 | 80 | 510 | 5 |

1513

1/2" Havalı Lokma Adaptörü
Impact Socket Adapter



1/2"

Krom molibden, Fosfat kaplamalı
Chrom molybdenum, Phosphate finish

| KOD CODE | inch | g | TL/Ad. |
|--------------|-------------|-----|--------|
| 1513 06 7002 | 1/2"Fx3/8"M | 95 | 5 |
| 1513 06 7003 | 1/2"Fx3/4"M | 175 | 5 |

1513

1/2" Havalı Lokma Mafsal
Impact Socket Universal Joint



1/2"

Krom molibden, Fosfat kaplamalı
Chrom molybdenum, Phosphate finish

| KOD CODE | L mm | g | TL/Ad. |
|--------------|------|-----|--------|
| 1513 06 7075 | 75 | 220 | 5 |

1119

3/4" Altı Köşe Havalı Lokma Anahtar (mm) Impact Socket Wrench 6 Points (mm)

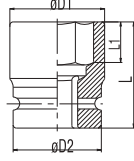

3/4"

Krom molibden, Fosfat kaplamalı
Chrom molybdenum, Phosphate finish

| KOD CODE | mm | Ø D1 mm | Ø D2 mm | L mm | L1 mm | g | TL/Ad. |
|--------------|----|---------|---------|------|-------|-----|--------|
| 1119 06 7019 | 19 | 32 | 44 | 50 | 13 | 330 | 5 |
| 1119 06 7021 | 21 | 35 | 44 | 50 | 15 | 340 | 5 |
| 1119 06 7022 | 22 | 36 | 44 | 50 | 15 | 345 | 5 |
| 1119 06 7024 | 24 | 38 | 44 | 50 | 16 | 350 | 5 |
| 1119 06 7027 | 27 | 42 | 44 | 53 | 17 | 380 | 5 |
| 1119 06 7030 | 30 | 46 | 44 | 53 | 20 | 410 | 1 |
| 1119 06 7032 | 32 | 48 | 44 | 57 | 20 | 460 | 1 |
| 1119 06 7034 | 34 | 51 | 44 | 57 | 22 | 490 | 1 |
| 1119 06 7036 | 36 | 53 | 44 | 57 | 22 | 520 | 1 |
| 1119 06 7041 | 41 | 59 | 44 | 58 | 24 | 580 | 1 |
| 1119 06 7046 | 46 | 66 | 44 | 62 | 24 | 715 | 1 |

1519

3/4" Havalı Lokma Ara Kol Impact Socket Extension Bar



3/4"

Krom molibden, Fosfat kaplamalı
Chrom molybdenum, Phosphate finish

| KOD CODE | L mm | g | TL/Ad. |
|--------------|------|------|--------|
| 1519 06 7175 | 175 | 865 | 5 |
| 1519 06 7250 | 250 | 1155 | 5 |
| 1519 06 7330 | 330 | 1425 | 5 |

1519

3/4" Havalı Lokma Mafsal Impact Socket Universal Joint



3/4"

Krom molibden, Fosfat kaplamalı
Chrom molybdenum, Phosphate finish

| KOD CODE | L mm | g | TL/Ad. |
|--------------|------|-----|--------|
| 1519 06 7108 | 108 | 735 | 5 |

1519

3/4" Havalı Lokma Adaptörü Impact Socket Adapter



3/4"

Krom molibden, Fosfat kaplamalı
Chrom molybdenum, Phosphate finish

| KOD CODE | inch | g | TL/Ad. |
|--------------|-------------|-----|--------|
| 1519 06 7011 | 3/4"Fx1/2"M | 315 | 5 |

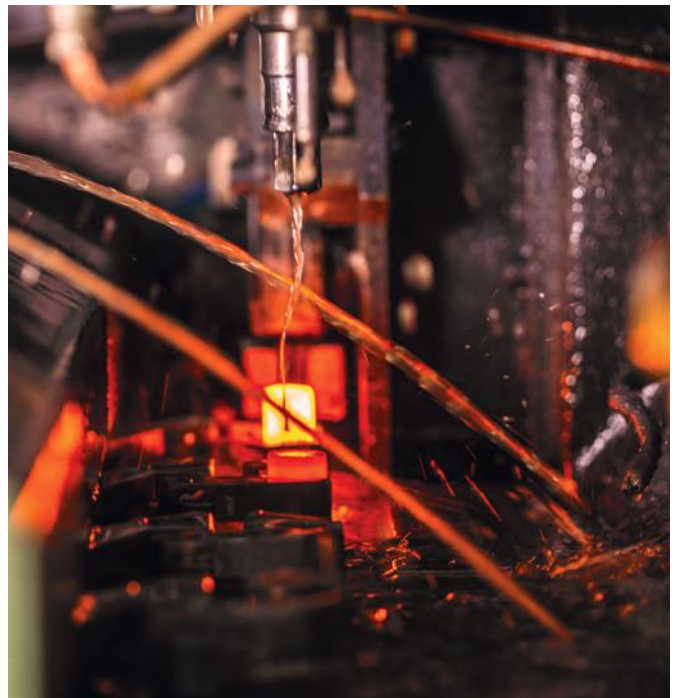

(*) İşaretili olan ürünler stoklarla sınırlıdır.
Limited with stocks.

1" Altı Köşe Havalı Lokma Anahtar (mm)
Impact Socket Wrench 6 Points (mm)

1"

Krom molibden, Fosfat kaplamalı
Chrom molybdenum, Phosphate finish

| KOD CODE | mm | Ø D1 mm | Ø D2 mm | L mm | L1 mm | g | TL/Ad. |
|--------------|----|---------|---------|------|-------|------|--------|
| 1125 06 7024 | 24 | 41 | 54 | 58 | 17 | 560 | 1 |
| 1125 06 7027 | 27 | 44 | 54 | 58 | 19 | 565 | 1 |
| 1125 06 7030 | 30 | 48 | 54 | 60 | 21 | 605 | 1 |
| 1125 06 7032 | 32 | 51 | 54 | 62 | 21 | 650 | 1 |
| 1125 06 7033 | 33 | 52 | 54 | 62 | 21 | 660 | 1 |
| 1125 06 7034 | 34 | 53 | 54 | 62 | 24 | 765 | 1 |
| 1125 06 7036 | 36 | 56 | 54 | 65 | 24 | 720 | 1 |
| 1125 06 7038 | 38 | 58 | 54 | 65 | 26 | 735 | 1 |
| 1125 06 7041 | 41 | 61 | 54 | 70 | 28 | 845 | 1 |
| 1125 06 7046 | 46 | 68 | 54 | 75 | 30 | 1075 | 1 |
| 1125 06 7050 | 50 | 73 | 54 | 75 | 32 | 1170 | 1 |
| 1125 06 7055 | 55 | 79 | 54 | 83 | 37 | 1435 | 1 |
| 1125 06 7060 | 60 | 86 | 54 | 87 | 37 | 1760 | 1 |

1" Havalı Lokma Ara Kol
Impact Socket Extension Bar

1"
Krom molibden, Fosfat kaplamalı
Chrom molybdenum, Phosphate finish

| KOD CODE | L mm | g | TL/Ad. |
|--------------|------|------|--------|
| 1525 06 7175 | 175 | 1395 | 5 |
| 1525 06 7250 | 250 | 1890 | 5 |
| 1525 06 7330 | 330 | 2455 | 5 |

1" Havalı Lokma Mafsal
Impact Socket Universal Joint

1"
Krom molibden, Fosfat kaplamalı
Chrom molybdenum, Phosphate finish

| KOD CODE | L mm | g | TL/Ad. |
|--------------|------|------|--------|
| 1525 06 7128 | 128 | 1530 | 1 |

1" Havalı Lokma Adaptörü
Impact Socket Adapter

1"
Krom molibden, Fosfat kaplamalı
Chrom molybdenum, Phosphate finish

| KOD CODE | inch | g | TL/Ad. |
|--------------|-----------|-----|--------|
| 1525 06 7015 | 1"Fx3/4"M | 560 | 5 |



1800

Kovan Anahtar İki Ağız (mm) Double Ended Tubular Socket Wrench (mm)

TS ISO 3793
DIN 896

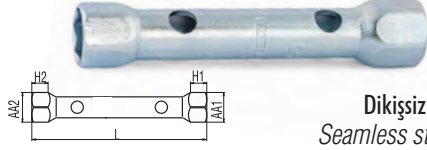

Dikişsiz çelik boru, Çinko kaplı
Seamless steel tube, Zinc plated

| KOD CODE | mm | L mm | AA1 mm | AA2 mm | H1 mm | H2 mm | g | TL/Ad. |
|--------------|-------|------|--------|--------|-------|-------|-----|--------|
| 1800 07 0607 | 6x7 | 105 | 8.6 | 9.6 | 7 | 8 | 25 | 5 |
| 1800 07 0809 | 8x9 | 105 | 11.2 | 12.2 | 9 | 10 | 35 | 5 |
| 1800 07 1011 | 10x11 | 120 | 13.6 | 14.6 | 11 | 11.5 | 55 | 5 |
| 1800 07 1213 | 12x13 | 135 | 16 | 17 | 12 | 12.5 | 80 | 5 |
| 1800 07 1415 | 14x15 | 135 | 18.5 | 19.5 | 13 | 13.5 | 110 | 5 |
| 1800 07 1617 | 16x17 | 150 | 21 | 22 | 14 | 14.5 | 150 | 5 |
| 1800 07 1819 | 18x19 | 150 | 23 | 24 | 15 | 15.5 | 170 | 5 |
| 1800 07 2022 | 20x22 | 165 | 25.4 | 27.4 | 16 | 18 | 220 | 5 |
| 1800 07 2224 | 22x24 | 180 | 27.4 | 29.4 | 18 | 20 | 330 | 5 |
| 1800 07 2427 | 24x27 | 180 | 30.4 | 33.4 | 20 | 23 | 400 | 5 |

1800

Kovan Anahtar Takımı İki Ağız (mil dahil, mm) Double Ended Tubular Socket Wrench Set with Tommy Bars (mm)

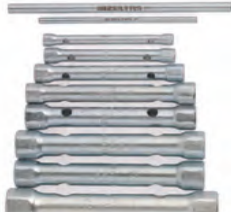

| KOD CODE | mm | g | TL/Ad. |
|--------------|--|-----|--------|
| 1800 00 2108 | 6x7 - 8x9 - 10x11 - 12x13 - 14x15 16x17 - 18x19 - 20x22 Mil/Handle Bars 5x125-8x180 mm | 920 | 10 |

1841

Kovan Anahtar Bir Ağız (mil dahil) Single Ended Tubular Socket Wrench with Tommy Bar



Dikişsiz çelik boru, Çinko kaplı
Seamless steel tube, Zinc plated

| KOD CODE | mm | | L mm | ØD mm | Mil Handle bar mm | g | TL/Ad. |
|--------------|----|--------|------|-------|-------------------|-----|--------|
| | mm | inch | | | | | |
| 1841 07 0021 | 21 | 13/16" | 120 | 20 | 10x120 | 215 | 5 |

1850

Kovan Anahtar Mili Tommy Bar

TS ISO 3793
DIN 900



| KOD CODE | ØDxL mm | g | TL/Ad. |
|--------------|---------|-----|--------|
| 1850 07 5125 | 5x125 | 20 | 10 |
| 1850 07 8180 | 8x180 | 70 | 10 |
| 1850 07 1120 | 10x120 | 75 | 10 |
| 1850 07 1200 | 10x200 | 120 | 10 |

1870

Ağır Tip Bijon Anahtarı İki Ağız Uzun Double Ended Rim Wrench (long)

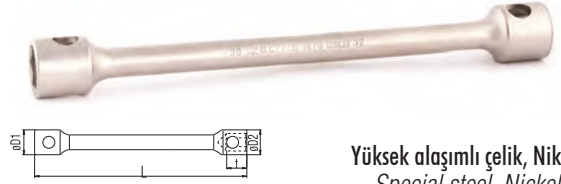

Yüksek alaşımlı çelik, Nikel kaplı
Special steel, Nickel plated

| KOD CODE | mm | L mm | t mm | ØD1 mm | ØD2 mm | g | TL/Ad. |
|--------------|-------|------|------|--------|--------|------|--------|
| 1870 09 2427 | 24x27 | 400 | 34.5 | 36 | 40 | 1135 | 10 |
| 1870 09 2730 | 27x30 | 400 | 34.5 | 40 | 44 | 1380 | 10 |
| 1870 09 2732 | 27x32 | 400 | 34.5 | 40 | 46 | 1380 | 10 |
| 1870 09 3032 | 30x32 | 400 | 34.5 | 44 | 46 | 1380 | 10 |
| 1870 09 3233 | 32x33 | 400 | 34.5 | 46 | 47 | 1450 | 10 |

1874

Ağır Tip Bijon Anahtarı İki Ağız Kısa Double Ended Rim Wrench (short)

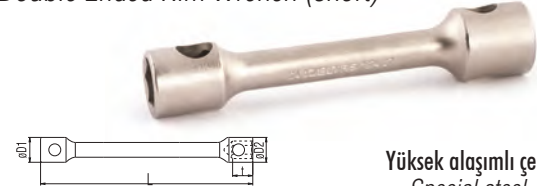

Yüksek alaşımlı çelik, Nikel kaplı
Special steel, Nickel plated

| KOD CODE | mm | L mm | t mm | ØD1 mm | ØD2 mm | g | TL/Ad. |
|--------------|-------|------|------|--------|--------|-----|--------|
| 1874 09 2224 | 22x24 | 170 | 34.5 | 34 | 36 | 720 | 10 |
| 1874 09 2427 | 24x27 | 200 | 34.5 | 36 | 40 | 800 | 10 |

1850

Bijon Anahtar Mili Tommy Bar

TS ISO 3793
DIN 900



| KOD CODE | ØDxL mm | g | TL/Ad. |
|--------------|---------|------|--------|
| 1850 09 1630 | 18x630 | 1260 | 1 |

(★) İşaretili olan ürünler stoklarla sınırlıdır.
Limited with stocks.

1975

Bijon Anahtarı İstavroz Tipi Cross Rim Wrench

TS ISO 6788

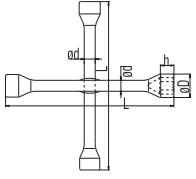

Yüksek alaşımlı çelik, Krom kaplı
Special steel, Chrom plated

| KOD CODE | mm | inch | øD mm | h mm | L mm | ød mm | g | TL/Ad. |
|--------------|----|--------|-------|------|------|-------|------|--------|
| | 17 | 11/16" | 28 | 17 | | | | |
| 1975 09 1719 | 19 | 3/4" | 30 | 18.5 | 420 | 16 | 1422 | 10 |
| | 21 | 13/16" | 32 | 19.5 | | | | |
| | 22 | 7/8" | 34 | 20.5 | | | | |

1975

1/2" Adaptörlü Bijon Anahtarı İstavroz Tipi Cross Rim Wrench (with 1/2" adapter)

TS ISO 6788

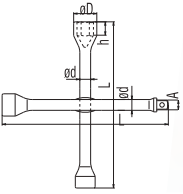

Yüksek alaşımlı çelik, Krom kaplı
Special steel, Chrom plated

| KOD CODE | mm | inch | øD mm | h mm | L mm | A mm | ød mm | g | TL/Ad. |
|--------------|----|--------|-------|------|------|-------|-------|------|--------|
| | 17 | 11/16" | 28 | 17 | | | | | |
| 1975 09 1322 | 19 | 3/4" | 30 | 18.5 | 420 | 12.65 | 16 | 1375 | 10 |
| | 22 | 7/8" | 34 | 20.5 | | | | | |
| | | 1/2" | | | | | | | |

1940

Bijon Anahtarı Pipo Tipi (Tornavida Ağızlı) Offset Socket Wrench with Screwdriver

TSEK

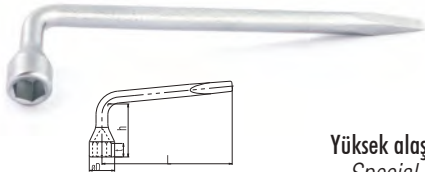

Yüksek alaşımlı çelik, Krom kaplı
Special steel, Chrom plated

| KOD CODE | mm | inch | L mm | øD mm | h mm | g | TL/Ad. |
|--------------|----|--------|------|-------|------|-----|--------|
| 1940 09 0017 | 17 | 11/16" | 285 | 28 | 65 | 485 | 10 |
| 1940 09 0019 | 19 | 3/4" | 285 | 30 | 65 | 470 | 10 |
| 1940 09 0021 | 21 | 13/16" | 320 | 32 | 85 | 575 | 10 |

1840

1/2" Mafsallı T Kol Swivel Handle With Sliding T 1/2"

Özel alaşım çelik, Krom kaplı
Special steel, Chrom plated

1/2"

| KOD CODE | mm | L mm | g | TL/Ad. |
|--------------|------|------|-----|--------|
| 1840 08 0500 | 1/2" | 600 | 740 | 10 |

1855

Mafsallı T Kol Lokma T - Handle Wrench with Universal Joint

Özel alaşım çelik, Krom kaplı
Special steel, Chrom plated

| KOD CODE | mm | L mm | g | TL/Ad. |
|--------------|----|------|-----|--------|
| 1855 08 0008 | 8 | 400 | 225 | 10 |
| 1855 08 0010 | 10 | 450 | 405 | 10 |
| 1855 08 0012 | 12 | 450 | 410 | 10 |
| 1855 08 0013 | 13 | 450 | 425 | 10 |
| 1855 08 0017 | 17 | 500 | 485 | 10 |
| 1855 08 0019 | 19 | 510 | 895 | 10 |

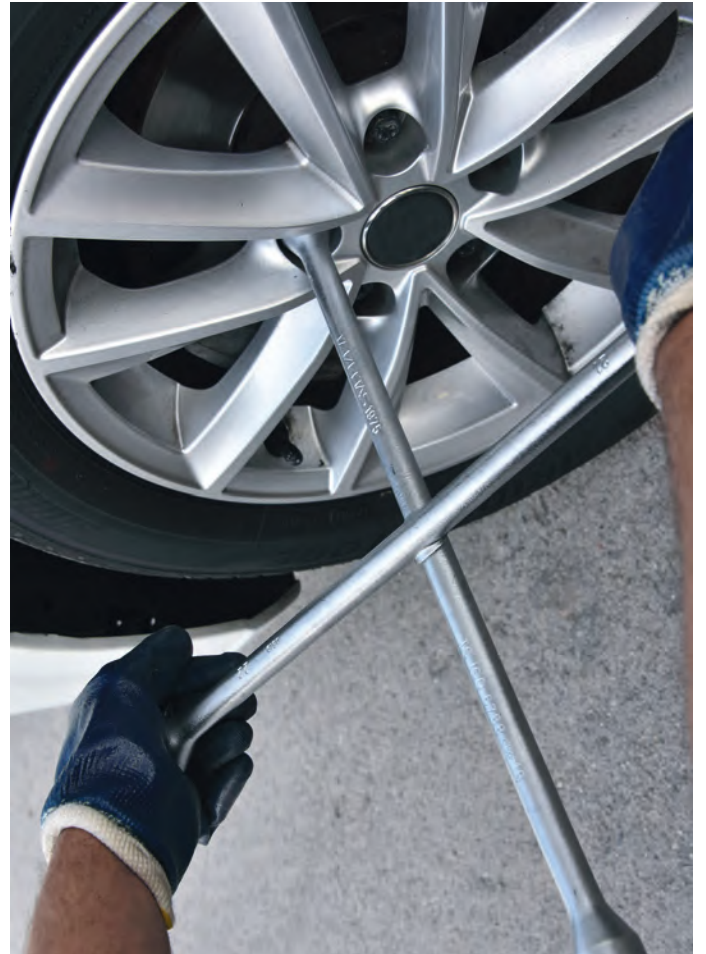

(*) İşaretili olan ürünler stoklarla sınırlıdır.
Limited with stocks.

1610

3/8" Tork Anahtarı
Torque Wrench

TS EN ISO 6789-1
TS EN ISO 6789-2



3/8"

| KOD CODE | ÖLÇÜ SIZE | L mm | g | TL/Ad. |
|--------------|----------------------------|------|-----|--------|
| 1610 06 0100 | 2.5 - 11 Nm - 0.3 - 1.2 Kg | 310 | 515 | 1 |
| 1610 06 0300 | 7 - 33 Nm - 0.5 - 3.4 Kg | 425 | 640 | 1 |

1613

1/2" Tork Anahtarı
Torque Wrench

TS EN ISO 6789-1
TS EN ISO 6789-2



1/2"

| KOD CODE | ÖLÇÜ SIZE | L mm | g | TL/Ad. |
|--------------|-------------------------|------|------|--------|
| 1613 06 1200 | 25 - 135 Nm - 3 - 14 Kg | 550 | 1430 | 1 |
| 1613 06 2000 | 50 - 225 Nm - 5 - 23 Kg | 600 | 2165 | 1 |
| 1613 06 3000 | 70 - 330 Nm - 7 - 35 Kg | 830 | 2870 | 1 |

1619

3/4" Tork Anahtarı
Torque Wrench

TS EN ISO 6789-1
TS EN ISO 6789-2



İZELTAS USTA İŞİ
SOHBETLER

3/4"

| KOD CODE | ÖLÇÜ SIZE | L mm | g | TL/Ad. |
|--------------|-----------------------|------|------|--------|
| 1619 06 2080 | 200 - 800 Nm-22-82 kg | 1030 | 8860 | 1 |

1607

1/4" Cırcırlı Tork Anahtar
Torque Wrench With Reversible Ratchet-Head

TS EN ISO 6789-1
TS EN ISO 6789-2



İZELTAS YOUTUBE

1/4"

| KOD CODE | ÖLÇÜ SIZE | L mm | g | TL/Ad. |
|--------------|-----------|------|-----|--------|
| 1607 06 0420 | 4 - 20 Nm | 320 | 640 | 1 |

1610

3/8" Cırcırlı Tork Anahtar
Torque Wrench With Reversible Ratchet-Head

TS EN ISO 6789-1
TS EN ISO 6789-2



3/8"

| KOD CODE | ÖLÇÜ SIZE | L mm | g | TL/Ad. |
|--------------|-------------|------|------|--------|
| 1610 06 2010 | 20 - 100 Nm | 435 | 1300 | 1 |

1613

1/2" Cırcırlı Tork Anahtar
Torque Wrench With Reversible Ratchet-Head

TS EN ISO 6789-1
TS EN ISO 6789-2



1/2"

| KOD CODE | ÖLÇÜ SIZE | L mm | g | TL/Ad. |
|--------------|-----------|------|------|--------|
| 1613 06 4020 | 40- 200Nm | 520 | 1590 | 1 |
| 1613 06 6034 | 60- 340Nm | 610 | 1810 | 1 |

1619

3/4" Cırcırlı Tork Anahtar
Torque Wrench With Reversible Ratchet-Head

TS EN ISO 6789-1
TS EN ISO 6789-2



3/4"

| KOD CODE | ÖLÇÜ SIZE | L mm | g | TL/Ad. |
|--------------|------------|------|------|--------|
| 1619 06 1060 | 100-600 Nm | 1050 | 5600 | 1 |

(★) İşaretili olan ürünler stoklarla sınırlıdır.
Limited with stocks.

Lokmayı salmayan bilya tasarımı
(kare adaptörlü bilyalı tasarım)
Square adaptor with ball design to lock sockets

Değiştirilebilir iç mekanizma
Inter-changeable inner mechanism

Yüksek dayanım için
güçlü 32 diş
32 teeth for high
endurance

Çift yönlü kullanım
sağlayan mandal tasarımı
Bi-directional latch design

Yüksek mukavemetli
alaşımli sıcak dövme çeliği
High strength alloyed cold work tool steel

Nikel üzerine krom
kaplama ile korozyon
direncinde üst seviye koruma
High corrosion resistance with chrome over
nickel plating

Dayanımı yüksek sert plastikten ve
konforlu tutuş sağlayan yumuşak
elastomer malzemeden imal edilmiş çift
komponentli ergonomik sap
Two component ergonomic handle with high strength and soft
grip plastic



İZELTAS USTA İŞİ
SOHBETLER



İZELTAS YOUTUBE

IZELTAS®

BORU ANAHTARLARI VE PENSELER

PIPE WRENCHES AND PLIERS

Boru Anahtarları
Pipe Wrenches

Fort Penseler
Water Pump Pliers

Ayarlı Penseler
Grip Wrenches

Penseler
Pliers

Kargaburunlar
Nose Pliers

Kerpetenler
Carpenter Pincers

Elektronikçi Penseler
Electronic Pliers

BORU
ANAHTARLARI
PENSELER

PIPE WRENCHES
AND PLIERS



İZELTAS YOUTUBE



Güçlü kavrama sağlayan
tırnaklı tutma yüzeyleri
Toothed surface for strong grip

Isıl işlem sonrasında indüksiyonda
sertleştirme ile kullanım ömrü
artırılmış kesici ağızlar
Heat-treated and induction hardened cutting edges for long
lifetime

Nikel üzerine krom kaplama ile
korozyon direncinde
üst seviye koruma
High corrosion resistance
with chrome over nickel plating

Yüksek karbonlu
sıcak dövme
çeliği ile artırılmış
dayanım
High carbon forged steel for
improved durability

Düşmelere ve darbeye dayanıklı,
selüloz asetat ergonomik sap
Impact resistant cellulose acetate handle

2100

Stilson Boru Anahtarı Pipe Wrench, Stilson



TS 3796



Yedek parça sayfa 198
Spare parts page 198

| KOD CODE | L mm | L inch | mm | ÖLÇÜ SIZE Inch | g | | TL/Ad. |
|--------------|------|--------|----|----------------|------|---|--------|
| 2100 10 0008 | 200 | 8" | | 3/4" | 280 | 1 | |
| 2100 10 0010 | 250 | 10" | | 1" | 550 | 1 | |
| 2100 10 0012 | 300 | 12" | | 1 1/4" | 725 | 1 | |
| 2100 10 0014 | 350 | 14" | | 1 1/2" | 1030 | 1 | |
| 2100 10 0018 | 450 | 18" | | 2" | 1775 | 1 | |
| 2100 10 0024 | 600 | 24" | | 2 1/2" | 2775 | 1 | |

2110

Ağır Tip Boru Anahtarı Pipe Wrench, Heavy Duty



Yedek parça sayfa 198
Spare parts page 198

Krom vanadyum, Dişler indüksiyonda sertleştirilmiş, Elektrostatik boyanmış
Chrom vanadium, Teeth induction hardened, Electrostatically painted

| KOD CODE | L mm | L inch | mm | ÖLÇÜ SIZE Inch | g | | TL/Ad. |
|--------------|------|--------|-----|----------------|-------|---|--------|
| 2110 10 0008 | 200 | 8" | 34 | 1" | 425 | 1 | |
| 2110 10 0010 | 250 | 10" | 42 | 1 1/4" | 795 | 1 | |
| 2110 10 0012 | 300 | 12" | 50 | 1 1/2" | 1245 | 1 | |
| 2110 10 0014 | 350 | 14" | 60 | 2" | 1710 | 1 | |
| 2110 10 0018 | 450 | 18" | 75 | 2 1/2" | 2685 | 1 | |
| 2110 10 0024 | 600 | 24" | 90 | 3" | 4370 | 1 | |
| 2110 10 0036 | 900 | 36" | 140 | 5" | 7600 | 1 | |
| 2110 10 0048 | 1200 | 48" | 165 | 6" | 15600 | 1 | |

2201

Maşalı Boru Anahtarı (85°) Pipe Wrench (85°)



TS 3796
DIN 5234



Yedek parça sayfa 198
Spare parts page 198

Krom vanadyum, Dişler indüksiyonda sertleştirilmiş, Elektrostatik boyanmış
Chrom vanadium, Teeth induction hardened, Electrostatically painted

| KOD CODE | L mm | mm | ÖLÇÜ SIZE Inch | g | | TL/Ad. |
|--------------|------|-----|----------------|------|---|--------|
| 2201 10 0010 | 325 | 40 | 1" | 870 | 1 | |
| 2201 10 0015 | 430 | 60 | 1 1/2" | 1585 | 1 | |
| 2201 10 0020 | 585 | 70 | 2" | 2700 | 1 | |
| 2201 10 0030 | 690 | 100 | 3" | 4270 | 1 | |
| 2201 10 0040 | 760 | 130 | 4" | 5800 | 1 | |

(★) İşaretili olan ürünler stoklarla sınırlıdır.
Limited with stocks.

Üniversal Fort Pense
Waterpump Pliers UniversalTS 60 TS ISO 8976
DIN ISO 8976

İZELTAŞ YOUTUBE

Krom vanadyum, Krom kaplı, PVC izoleli
Chrom vanadium, Chrom plated, PVC insulated

| KOD CODE | L mm | L inch | mm | g | TL/Ad. |
|--------------|------|---------|----|-----|--------|
| 2400 11 0160 | 160 | 6 1/4" | 30 | 125 | 5 |
| 2400 11 0240 | 240 | 9 1/2" | 35 | 355 | 5 |
| 2400 11 0315 | 315 | 12 1/2" | 40 | 530 | 5 |

1000V İzoleli Üniversal Fort Pense
Insulated Type Waterpump Pliers Universal 1000VTS 60
TS ISO 8976**Krom vanadyum, Krom kaplı, çift komponent saplı**
Chrom vanadium, Chrom plated, Two component handle

| KOD CODE | L mm | L inch | mm | g | TL/Ad. |
|--------------|------|--------|----|-----|--------|
| 2400 11 6240 | 240 | 9 1/2" | 35 | 370 | 5 |

Yaylı Fort Pense
Waterpump Pliers With SpringİZELTAŞ USTA İŞİ
SOHBETLER**Krom vanadyum, Karartma, PVC izoleli**
Chrom vanadium, Black finish, PVC insulated

| KOD CODE | L mm | L inch | mm | g | TL/Ad. |
|--------------|------|--------|----|-----|--------|
| 2415 11 0240 | 240 | 9 1/2" | 35 | 365 | 5 |

**(★) İşaretili olan ürünler stoklarla sınırlıdır.**
Limited with stocks.

2500
Üniversal Ayarlı Pense
Universal Grip

Çeneler krom vanadyum çeliğinden dövülmüştür, Nikel kaplama,
 Kullanım sahası: Yuvarlak ve düz malzemeler
Jaws Chrom vanadium forged, Nickel plated
 Application field : Flat and round materials

| KOD CODE | L mm | L inch | mm | g | TL/Ad. |
|--------------|------|--------|----|-----|--------|
| 2500 11 0250 | 250 | 10" | 30 | 560 | 5 |

2510
Spesiyal Ayarlı Pense
Special Grip

Çeneler krom vanadyum çeliğinden dövülmüştür, Nikel kaplama,
 Kullanım sahası: Yuvarlak ve düz malzemeler
Jaws Chrom vanadium forged, Nickel plated
 Application field: Flat and round materials

| KOD CODE | L mm | L inch | mm | g | TL/Ad. |
|--------------|------|--------|----|-----|--------|
| 2510 11 0250 | 250 | 10" | 30 | 550 | 5 |

2505
Standart Ayarlı Pense
Standard Grip
TSEK

Çeneler krom vanadyum çeliğinden dövülmüştür, Nikel kaplama
 Kullanım sahası: Düz malzemeler
Jaws, Chrom vanadium forged, Nickel plated
 Application field: Flat materials

| KOD CODE | L mm | L inch | mm | g | TL/Ad. |
|--------------|------|--------|----|-----|--------|
| 2505 11 0250 | 250 | 10" | 30 | 535 | 5 |

2511
C tipi Ayarlı Pense
Clamp Grip C-type

Çeneler krom vanadyum çeliğinden dövülmüştür, Nikel kaplama,
 Kullanım sahası: Açılı profillerin tutulmasında
Jaws Chrom vanadium forged, Nickel plated
 Application field: For Gripping angled sheet metal

| KOD CODE | L mm | L inch | mm | g | TL/Ad. |
|--------------|------|--------|----|-----|--------|
| 2511 11 0280 | 280 | 11" | 70 | 700 | 1 |



Kaynakçı Ayarlı Pense (Düz Ağız)
Lock Grip With Flat Jaws

Özel alaşımli çelikten imal edilmiş, Nikel kaplama,
Kullanım sahası: 80 mm düz çeneleri ile kıvrık metal levhaları
*Made from special alloy steel, Nickel plated, Application field:
Gripping sheet metals with 80 mm Flat jaws*

| KOD CODE | L mm | L inch |  mm |  g |  | TL/Ad. |
|--------------|---------|-----------|---|--|---|--------|
| 2512 11 0200 | 200 | 8" | 30 | 485 | 1 | |

Kaportacı Ayarlı Pense
Welding Grip

Özel alaşımli çelikten imal edilmiş- Nikel kaplama,
Kullanım sahası: Yassı ve köşeli malzemelerde
*Made from special alloy steel, Nickel plated
Application field : Angled corners and edges*

| KOD CODE | L mm | L inch |  mm |  g |  | TL/Ad. |
|--------------|---------|-----------|---|--|---|--------|
| 2515 11 0270 | 270 | 10 5/8" | 50 | 765 | 1 | |

Kaynakçı Ayarlı Pense (Boru İçin)
Grip For Tubes

Özel alaşımli çelikten imal edilmiş, Nikel kaplama,
Kullanım sahası: Boru malzemeler
Made from special alloy steel, Nickel plated, Application field: Tubes

| KOD CODE | L mm | L inch |  mm |  g |  | TL/Ad. |
|--------------|---------|-----------|---|--|---|--------|
| 2513 11 0280 | 280 | 11" | 50 | 800 | 1 | |

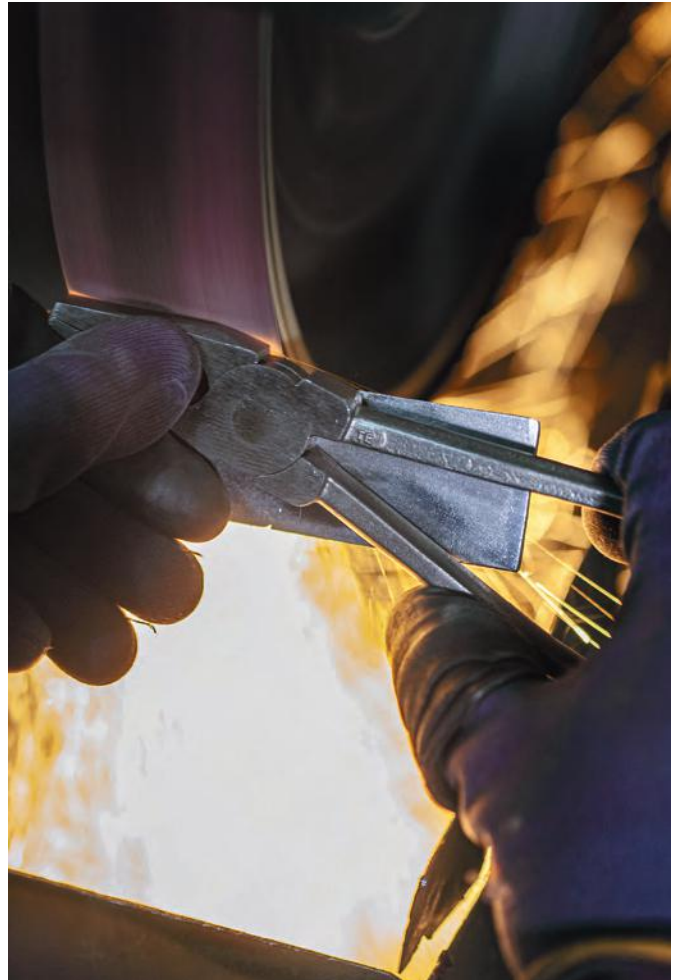

(★) İşaretili olan ürünler stoklarla sınırlıdır.
Limited with stocks.

3020

Kombine Pense Opak Seri Combination Pliers

TS 60
TS ISO 5746
DIN ISO 5746



İZELTAS YOUTUBE

Özel alaşımli çelik, Kesici ağızlar indüksiyonda sertleştirilmiş
Special steel, Cutters induction hardened

| KOD CODE | L mm | L inch | g | TL/Ad. |
|--------------|------|--------|-----|--------|
| 3020 12 2160 | 160 | 6 1/4" | 205 | 5 |
| 3020 12 2180 | 180 | 7 1/8" | 275 | 5 |
| 3020 12 2200 | 200 | 8" | 315 | 5 |

3020

Kombine Pense Kraft Seri Combination Pliers

TS 60
TS ISO 5746
DIN ISO 5746



Özel alaşımli çelik, Kesici ağızlar indüksiyonda sertleştirilmiş
Special steel, Cutters induction hardened

| KOD CODE | L mm | L inch | g | TL/Ad. |
|--------------|------|--------|-----|--------|
| 3020 12 3160 | 160 | 6 1/4" | 225 | 5 |
| 3020 12 3180 | 180 | 7 1/8" | 285 | 5 |
| 3020 12 3200 | 200 | 8" | 380 | 5 |

★3020

Kombine Pense Ergonomik Seri Combination Pliers

TS 60
TS ISO 5746
DIN ISO 5746



Özel alaşımli çelik, Kesici ağızlar indüksiyonda sertleştirilmiş
Special steel, Cutters induction hardened

| KOD CODE | L mm | L inch | g | TL/Ad. |
|---------------|------|--------|-----|--------|
| ★3020 12 5160 | 160 | 6 1/4" | 205 | 5 |
| ★3020 12 5180 | 180 | 7 1/8" | 260 | 5 |
| ★3020 12 5200 | 200 | 8" | 345 | 5 |

3020

1000V İzoleli Elektrikçi Kombine Pense Electrician Type Insulated Combination Pliers 1000V



TS 60
TS ISO 5746
DIN ISO 5746



1000 V
IEC 60900



Özel alaşımli çelik, Kesici ağızlar indüksiyonda sertleştirilmiş, Krom kaplı
Special steel, Cutters induction hardened, Chrom plated

| KOD CODE | L mm | L inch | g | TL/Ad. |
|--------------|------|--------|-----|--------|
| 3020 12 6160 | 160 | 6 1/4" | 205 | 5 |
| 3020 12 6180 | 180 | 7 1/8" | 260 | 5 |
| 3020 12 6200 | 200 | 8" | 345 | 5 |

3030

Kombine Pense Ağır Tip (çelik tel için) Combination Pliers Heavy Duty (for piano wire)



Özel alaşımli çelik, Kesici ağızlar indüksiyonda sertleştirilmiş,
Special steel, Cutters induction hardened

| KOD CODE | L mm | L inch | g | TL/Ad. |
|--------------|------|--------|-----|--------|
| 3030 12 2180 | 180 | 7 1/8" | 285 | 5 |
| 3030 12 2200 | 200 | 8" | 380 | 5 |

(★) İşaretili olan ürünler stoklarla sınırlıdır.
Limited with stocks.

Kargaburun Düz Uçlu Opak Seri
Long Nose Pliers (Flat)

TS 60 - TS ISO 5745
DIN ISO 5745



İZELTAS YOUTUBE

Özel alaşımli çelik, Kesici ağızlar indüksiyonda sertleştirilmiş
Special steel, Cutters induction hardened

| KOD CODE | L mm | L inch | g | □ | TL/Ad. |
|--------------|------|--------|-----|---|--------|
| 3220 13 2140 | 140 | 5 1/2" | 110 | 5 | |
| 3220 13 2160 | 160 | 6 1/4" | 135 | 5 | |
| 3220 13 2180 | 180 | 7 1/8" | 170 | 5 | |
| 3220 13 2200 | 200 | 8" | 205 | 5 | |

Kargaburun Düz Uçlu Kraft Seri
Long Nose Pliers (Flat)

TS 60 - TS ISO 5745
DIN ISO 5745



Özel alaşımli çelik, Kesici ağızlar indüksiyonda sertleştirilmiş
Special steel, Cutters induction hardened

| KOD CODE | L mm | L inch | g | □ | TL/Ad. |
|--------------|------|--------|-----|---|--------|
| 3220 13 3140 | 140 | 5 1/2" | 120 | 5 | |
| 3220 13 3160 | 160 | 6 1/4" | 155 | 5 | |
| 3220 13 3180 | 180 | 7 1/8" | 185 | 5 | |
| 3220 13 3200 | 200 | 8" | 210 | 5 | |

Kargaburun Düz Uçlu Ergonomik Seri
Long Nose Pliers (Flat)

TS 60 - TS ISO 5745
DIN ISO 5745



Özel alaşımli çelik, Kesici ağızlar indüksiyonda sertleştirilmiş
Special steel, Cutters induction hardened

| KOD CODE | L mm | L inch | g | □ | TL/Ad. |
|---------------|------|--------|-----|---|--------|
| ★3220 13 5140 | 140 | 5 1/2" | 110 | 5 | |
| ★3220 13 5160 | 160 | 6 1/4" | 140 | 5 | |
| ★3220 13 5180 | 180 | 7 1/8" | 160 | 5 | |
| ★3220 13 5200 | 200 | 8" | 170 | 5 | |

1000V İzoleli Elektrikçi Kargaburun Düz Uçlu
Insulated Electrician Type
Long Nose Pliers 1000V



TS 60
TS ISO 5745
DIN ISO 5745
⚡ 1000
IEC 60900



Özel alaşımli çelik, Kesici ağızlar indüksiyonda sertleştirilmiş, Krom kaplı
Special steel, Cutters induction hardened, Chrom plated

| KOD CODE | L mm | L inch | g | □ | TL/Ad. |
|--------------|------|--------|-----|---|--------|
| 3220 13 6140 | 140 | 5 1/2" | 110 | 5 | |
| 3220 13 6160 | 160 | 6 1/4" | 140 | 5 | |
| 3220 13 6180 | 180 | 7 1/8" | 160 | 5 | |
| 3220 13 6200 | 200 | 8" | 170 | 5 | |

(★) İşaretili olan ürünler stoklarla sınırlıdır.
Limited with stocks.

3225
Kargaburun Eğri Uçlu Opak Seri
Long Nose Pliers (Bent)

TS 60 - TS ISO 5745

 Özel alaşımli çelik, Kesici ağızlar indüksiyonda sertleştirilmiş
Special steel, Cutters induction hardened

| KOD CODE | L mm | L inch | g | TL/Ad. |
|--------------|------|--------|-----|--------|
| 3225 13 2160 | 160 | 6 1/4" | 140 | 5 |
| 3225 13 2180 | 180 | 7 1/8" | 170 | 5 |
| 3225 13 2200 | 200 | 8" | 175 | 5 |

3020 00 2003
Opak Pense Seti 160mm (3 Parça)
Opak Pliers Set 160mm (3 Pcs)
ANAHTARLIK HEDİYELİ

| KOD CODE | L mm | İÇERİK CONTENTS | TL/Ad. |
|--------------|------|---|--------|
| 3020 12 2160 | 160 | Kombine Pense Opak Seri Combination Pliers 160mm | 1 |
| 3220 13 2160 | 160 | Kargaburun Düz Uçlu Opak Seri Long Nose Pliers (Flat) 160mm | 1 |
| 3700 16 2160 | 160 | Yan Keski Opak Seri Side Cutting Pliers 160mm | 1 |

3225
Kargaburun Eğri Uçlu Kraft Seri
Long Nose Pliers (Bent)

TS 60 - TS ISO 5745

 Özel alaşımli çelik, Kesici ağızlar indüksiyonda sertleştirilmiş
Special steel, Cutters induction hardened

| KOD CODE | L mm | L inch | g | TL/Ad. |
|--------------|------|--------|-----|--------|
| 3225 13 3160 | 160 | 6 1/4" | 150 | 5 |
| 3225 13 3180 | 180 | 7 1/8" | 190 | 5 |
| 3225 13 3200 | 200 | 8" | 195 | 5 |

3020 00 1002
Pense Kontrol Kalem Seti (2 Parça)
Opak Pliers Set, Voltage Tester (Flat) 2 Pcs
ANAHTARLIK HEDİYELİ

| KOD CODE | L mm | İÇERİK CONTENTS | TL/Ad. |
|--------------|------|---|--------|
| 3020 12 2160 | 160 | Kombine Pense Opak Seri Combination Pliers 160mm | 1 |
| 4550 17 0190 | 190 | Elektrik Kontrol Kalem (Düz Uçlu) Voltage Tester (Flat) 190mm | 1 |

Yan Keski Opak Seri
Side Cutting Pliers

TS 60 - TS ISO 5749
DIN ISO 5749



IZELTAS YOUTUBE

Özel alaşımli çelik, Kesici ağızlar indüksiyonda sertleştirilmiş
Special steel, Cutters induction hardened

| KOD CODE | L mm | L inch | g | | TL/Ad. |
|--------------|------|--------|-----|---|--------|
| 3700 16 2140 | 140 | 5 1/2" | 165 | 5 | |
| 3700 16 2160 | 160 | 6 1/4" | 230 | 5 | |
| 3700 16 2180 | 180 | 7 1/8" | 230 | 5 | |

Yan Keski Kraft Seri
Side Cutting Pliers

TS 60 • DIN ISO 5749
DIN ISO 5749



Özel alaşımli çelik, Kesici ağızlar indüksiyonda sertleştirilmiş
Special steel, Cutters induction hardened

| KOD CODE | L mm | L inch | g | | TL/Ad. |
|--------------|------|--------|-----|---|--------|
| 3700 16 3140 | 140 | 5 1/2" | 190 | 5 | |
| 3700 16 3160 | 160 | 6 1/4" | 240 | 5 | |
| 3700 16 3180 | 180 | 7 1/8" | 255 | 5 | |

Yan Keski Ergonomik Seri
Side Cutting Pliers

TS 60 - TS ISO 5749
DIN ISO 5749



Özel alaşımli çelik, Kesici ağızlar indüksiyonda sertleştirilmiş
Special steel, Cutters induction hardened

| KOD CODE | L mm | L inch | g | | TL/Ad. |
|---------------|------|--------|-----|---|--------|
| ★3700 16 5140 | 140 | 5 1/2" | 165 | 5 | |
| ★3700 16 5160 | 160 | 6 1/4" | 215 | 5 | |
| ★3700 16 5180 | 180 | 7 1/8" | 215 | 5 | |

1000V İzoleli Elektrikçi Yan Keski
Insulated Electrician Type Side Cutter 1000V

TS 60
TS ISO 5749
DIN ISO 5749
⚡ 1000 V

IEC 60900



Özel alaşımli çelik, Kesici ağızlar indüksiyonda sertleştirilmiş, Krom kaplı
Special steel, Cutters induction hardened, Chrom plated

| KOD CODE | L mm | L inch | g | | TL/Ad. |
|--------------|------|--------|-----|---|--------|
| 3700 16 6140 | 140 | 5 1/2" | 165 | 5 | |
| 3700 16 6160 | 160 | 6 1/4" | 215 | 5 | |
| 3700 16 6180 | 180 | 7 1/8" | 225 | 5 | |

(★) İşaretili olan ürünler stoklarla sınırlıdır.
Limited with stocks.

YAN KESKİ KRAFT SERİ / SIDE CUTTING PLIERS

Nikel üzerine krom kaplama ile
korozyon direncinde
üst seviye koruma
High corrosion resistance with chrome over nickel
plating

Isıl işlem sonrası ilave indüksiyonla sertleştirme ile
kullanım ömrü arttırılmış kesici ağızlar
Heat-treated and induction hardened cutting edges for long lifetime

Yüksek karbonlu sıcak dövme çeliği ile
arttırılmış dayanım
High carbon forged steel for
improved durability

TSE
standartlarına
uygun üretim
Production acc. to
TSE standards



Düşmelere ve darbeye
dayanıklı, selüloz
asetat ergonomik sap
Impact resistant cellulose
acetate handle



İZELTAS YOUTUBE

İnce Uçlu Yan Keski (Plastikler İçin)
Side Cutter For Plastics

TS 60
TS ISO 5749



Yan Keski Ağır Tip (Çelik Tel İçin)
Side Cutter Heavy Duty (for piano wire)



Özel alaşımli çelik, Kesici ağızlar indüksiyonda sertleştirilmiş, PVC izoleli
Special steel, Cutters induction hardened, PVC insulated

Özel alaşımli çelik, Kesici ağızlar indüksiyonda sertleştirilmiş
Special steel, Cutters induction hardened

| KOD CODE | L mm | L inch | g | TL/Ad. |
|--------------|------|--------|-----|--------|
| 3705 16 5160 | 160 | 6 1/4" | 220 | 5 |

| KOD CODE | L mm | L inch | g | TL/Ad. |
|--------------|------|--------|-----|--------|
| 3730 16 2160 | 160 | 6 1/4" | 200 | 5 |
| 3730 16 2200 | 200 | 8" | 320 | 5 |

Segman Pense Takımı (4 Parça)
Circlip Pliers Set (4 Pcs)



İZELTAS YOUTUBE

| KOD CODE | L mm | İÇERİK CONTENTS | TL Ad. |
|--------------|------|---|--------|
| 3301 12 0180 | 180 | Dış Segman Pense (Düz) Circlip Pliers, External (Flat) | 1 |
| 3311 12 0170 | 170 | Dış Segman Pense (Eğri) Circlip Pliers, External (Bent) | 1 |
| 3321 12 0180 | 180 | İç Segman Pense (Düz) Circlip Pliers, Internal (Flat) | 1 |
| 3331 12 0170 | 170 | İç Segman Pense (Eğri) Circlip Pliers, Internal (Bent) | 1 |



330112 0180
Dış Segman Pense (Düz) ● 19-60



3311 12 0170
Dış Segman Pense (Eğri) ● 19-60



3321 12 0180
İç Segman Pense (Düz) ● 19-60



3331 12 0170
İç Segman Pense (Eğri) ● 19-60



3301

Dış Segman Pense (Düz) Circlip Pliers, External (Flat)



TS 60
DIN 5254

Krom vanadyum, Krom kaplı, PVC izoleli
Chrom vanadium, Chrom plated, PVC insulated

| KOD CODE | L mm |  |  |  | TL/Ad. |
|--------------|------|---|---|---|--------|
| 3301 12 0140 | 140 | 10 - 25 | 90 | 5 | |
| 3301 12 0180 | 180 | 19 - 60 | 195 | 5 | |
| 3301 12 0225 | 225 | 40 - 100 | 235 | 5 | |
| 3301 12 0295 | 295 | 85 - 140 | 445 | 5 | |



3311

Dış Segman Pense (Eğri) Circlip Pliers, External (Bent)



TS 60
DIN 5254

Krom vanadyum, Krom kaplı, PVC izoleli
Chrom vanadium, Chrom plated, PVC insulated

| KOD CODE | L mm |  |  |  | TL/Ad. |
|--------------|------|---|---|---|--------|
| 3311 12 0125 | 125 | 10 - 25 | 105 | 5 | |
| 3311 12 0170 | 170 | 19 - 60 | 190 | 5 | |
| 3311 12 0210 | 210 | 40 - 100 | 250 | 5 | |
| 3311 12 0275 | 275 | 85 - 140 | 445 | 5 | |



3321

İç Segman Pense (Düz) Circlip Pliers Internal (Flat)



TS 60
DIN 5256

Krom vanadyum, Krom kaplı, PVC izoleli
Chrom vanadium, Chrom plated, PVC insulated

| KOD CODE | L mm |  |  |  | TL/Ad. |
|--------------|------|---|---|---|--------|
| 3321 12 0140 | 140 | 12 - 25 | 100 | 5 | |
| 3321 12 0180 | 180 | 19 - 60 | 185 | 5 | |
| 3321 12 0225 | 225 | 40 - 100 | 250 | 5 | |
| 3321 12 0310 | 310 | 85 - 140 | 445 | 5 | |



3331

İç Segman Pense (Eğri) Circlip Pliers Internal (Bent)



TS 60
DIN 5256

Krom vanadyum, Krom kaplı, PVC izoleli
Chrom vanadium, Chrom plated, PVC insulated

| KOD CODE | L mm |  |  |  | TL/Ad. |
|--------------|------|---|---|---|--------|
| 3331 12 0130 | 130 | 12 - 25 | 105 | 5 | |
| 3331 12 0170 | 170 | 19 - 60 | 185 | 5 | |
| 3331 12 0210 | 210 | 40 - 100 | 250 | 5 | |
| 3331 12 0290 | 290 | 85 - 140 | 440 | 5 | |



3420**Hortum Kelepçe Pensesi**
Hose Clamp Pliers

| KOD CODE | L mm | L inch | g | TL/Ad. |
|--------------|---------|-----------|-----|--------|
| 3420 12 0220 | 220 | 8 3/4" | 185 | 5 |

3425**Hortum Kelepçe Pensesi (Sıkıştırma Tipi)**
Hose Clamp Pliers

| KOD CODE | L mm | L inch | g | TL/Ad. |
|--------------|---------|-----------|-----|--------|
| 3425 12 0220 | 235 | 9 1/4" | 355 | 5 |

3852**Delik Zimba**
Revolving Punch PliersÖlçü / Size $\emptyset 2 - \emptyset 2.5 - \emptyset 3 - \emptyset 3.5 - \emptyset 4 - \emptyset 4.5$

| KOD CODE | L mm | L inch | g | TL/Ad. |
|--------------|---------|-----------|-----|--------|
| 3852 24 0225 | 225 | 9" | 270 | 5 |



3715

Tek Ağızlı Kablo Kesici
Cable Cutter



Özel alaşımlı çelik, Kesici ağızlar indüksiyonda sertleştirilmiş, PVC izoleli
Special steel, Cutters induction hardened, PVC insulated

| KOD CODE | L mm | L inch | g | TL/Ad. |
|--------------|------|--------|-----|--------|
| 3715 16 0165 | 165 | 6 1/4 | 210 | 5 |

3715

1000V İzoleli Tek Ağızlı Kablo Kesici
Cable Cutter 1000V

⚡ 1000 V
IEC 60900



Özel alaşımlı çelik, Kesici ağızlar indüksiyonda sertleştirilmiş
Special steel, Cutters induction hardened

| KOD CODE | L mm | L inch | g | TL/Ad. |
|--------------|------|--------|-----|--------|
| 3715 16 6165 | 165 | 6 1/4 | 230 | 5 |

(★) İşaretili olan ürünler stoklarla sınırlıdır.
Limited with stocks.

Çift Ağızlı Kablo Kesici
Cable Cutter, Double Cutter

Özel alaşımli çelik, Kesici ağızlar indüksiyonda sertleştirilmiş, PVC izoleli
Special steel, Cutters induction hardened, PVC insulated

| KOD CODE | L mm | L inch | g | TL/Ad. |
|--------------|---------|-----------|-----|--------|
| 3720 16 0220 | 220 | 9" | 320 | 5 |

Testere Çaprazı
Saw - Setting Pliers

TSEK



Özel alaşımli çelik, İndüksiyonda sertleştirilmiş,
Natural Vernikli, PVC izoleli
Special steel, induction hardened, PVC insulated

| KOD CODE | L mm | L inch | g | TL/Ad. |
|--------------|---------|-----------|-----|--------|
| 3860 26 0180 | 180 | 7 1/8" | 245 | 5 |



3550

Elektronikçi Yan Keski
Electronic Diagonal Side Cutting Pliers



Özel alaşımli çelik
Special steel

| KOD CODE | L mm | g | | TL/Ad. |
|--------------|------|----|---|--------|
| 3550 14 0125 | 125 | 76 | 5 | |

3553

Elektronikçi Düz Uçlu Kargaburun
Electronic Flat Nose Pliers



Özel alaşımli çelik
Special steel

| KOD CODE | L mm | g | | TL/Ad. |
|--------------|------|----|---|--------|
| 3553 14 0150 | 150 | 88 | 5 | |

3551

Elektronikçi Tepe Keski
Electronic End Cutting Pliers



Özel alaşımli çelik
Special steel

| KOD CODE | L mm | g | | TL/Ad. |
|--------------|------|----|---|--------|
| 3551 14 0125 | 125 | 77 | 5 | |

3554

Elektronikçi Uzun Kargaburun
Electronic Long Nose Pliers



Özel alaşımli çelik
Special steel

| KOD CODE | L mm | g | | TL/Ad. |
|--------------|------|----|---|--------|
| 3554 14 0150 | 150 | 88 | 5 | |

3552

Elektronikçi Yuvarlak Uçlu Kargaburun
Electronic Round Nose Pliers



Özel alaşımli çelik
Special steel

| KOD CODE | L mm | g | | TL/Ad. |
|--------------|------|----|---|--------|
| 3552 14 0125 | 125 | 78 | 5 | |

3555

Elektronikçi Sivri Uçlu Düz Kargaburun
Electronic Needle Flat Nose Pliers



Özel alaşımli çelik
Special steel

| KOD CODE | L mm | g | | TL/Ad. |
|--------------|------|----|---|--------|
| 3555 14 0150 | 150 | 86 | 5 | |

Elektronikçi Sivri Uçlu Eğri Kargaburun
Electronic Needle Bent Nose Pliers



Özel alaşımlı çelik
Special steel

| KOD CODE | L mm | g | | TL/Ad. |
|--------------|------|----|---|--------|
| 3556 14 0150 | 150 | 85 | 5 | |

Elektronikçi Pense
Electronic Pliers



Özel alaşımlı çelik
Special steel

| KOD CODE | L mm | g | | TL/Ad. |
|--------------|------|----|---|--------|
| 3557 14 0125 | 125 | 80 | 5 | |

Elektronikçi Keski ve Pense Seti (4 Parça)
Electronic Cutter & Pliers Set (4 Pcs)



| KOD CODE | L mm | İÇERİK CONTENTS | | TL Ad. |
|--------------|------|--|---|--------|
| 3550 14 0125 | 125 | Elektronikçi Yan Keski Electronic Diagonal Side Cutting Pliers | 1 | |
| 3551 14 0125 | 125 | Elektronikçi Tepe Keski Electronic End Cutting Pliers | 1 | |
| 3554 14 0150 | 150 | Elektronikçi Uzun kargaburun Electronic Long Nose Pliers | 1 | |
| 3557 14 0125 | 125 | Elektronikçi Pense Electronic Pliers | 1 | |

Elektronikçi Kargaburun Seti (4 Parça)
Electronic Long Nose Pliers Set (4 Pcs)



| KOD CODE | L mm | İÇERİK CONTENTS | | TL Ad. |
|--------------|------|--|---|--------|
| 3552 14 0125 | 125 | Elektronikçi Yuvarlak Uçlu Kargaburun Electronic Round Nose Pliers | 1 | |
| 3553 14 0150 | 150 | Elektronikçi Düz Uçlu Kargaburun Electronic Flat Nose Pliers | 1 | |
| 3555 14 0150 | 150 | Elektronikçi Sivri Uçlu Düz Kargaburun Electronic Needle Nose Pliers | 1 | |
| 3556 14 0150 | 150 | Elektronikçi Sivri Uçlu Eğri Kargaburun Electronic Bent Needle Nose Pliers | 1 | |

(★) İşaretili olan ürünler stoklarla sınırlıdır.
Limited with stocks.

3800

Kerpeten Carpenter Pincers

TS 60 - TS ISO 9243
DIN ISO 9243



Özel alaşımli çelik, Kesici ağızlar indüksiyonda sertleştirilmiş, PVC izoleli
Special steel, Cutters induction hardened, PVC insulated

| KOD CODE | L mm | L inch | g | TL/Ad. |
|--------------|------|--------|-----|--------|
| 3800 15 0160 | 160 | 6 1/4" | 220 | 5 |
| 3800 15 0180 | 180 | 7 1/8" | 295 | 5 |
| 3800 15 0200 | 200 | 8" | 330 | 5 |
| 3800 15 0250 | 250 | 10" | 530 | 5 |

3830

Betoncu Kerpeteni Tower Pincers

TS 60 • TS ISO 9242
DIN ISO 9242



Özel alaşımli çelik, Kesici ağızlar indüksiyonda sertleştirilmiş, PVC izoleli
Special steel, Cutters induction hardened, PVC insulated

| KOD CODE | L mm | L inch | g | TL/Ad. |
|--------------|------|--------|-----|--------|
| 3830 15 0225 | 225 | 9" | 345 | 5 |
| 3830 15 0250 | 250 | 10" | 395 | 5 |
| 3830 15 0280 | 280 | 11" | 450 | 5 |

3831

Betoncu Kerpeteni Yaylı Tower Pincers with spring

TS 60 - TS ISO 9242
DIN ISO 9242



Özel alaşımli çelik, Kesici ağızlar indüksiyonda sertleştirilmiş, PVC izoleli
Special steel, Cutters induction hardened, PVC insulated

| KOD CODE | L mm | L inch | g | TL/Ad. |
|--------------|------|--------|-----|--------|
| 3831 15 0280 | 280 | 11" | 455 | 5 |

3835

Ağır Tip Betoncu Kerpeteni Heavy Tower Pincers

TS 60 - TS ISO 9242
DIN ISO 9242



İZELTAS YOUTUBE

Özel alaşımli çelik, Kesici ağızlar indüksiyonda sertleştirilmiş, PVC izoleli
Special steel, Cutters induction hardened, PVC insulated

| KOD CODE | L mm | L inch | g | TL/Ad. |
|--------------|------|--------|-----|--------|
| 3835 15 0280 | 280 | 11" | 400 | 5 |

3850

Danallya Shoemaker Pliers



Özel alaşımli çelik, İndüksiyonda sertleştirilmiş, Siyah Oksit kaplı
Special steel, Induction hardened, Black finish

| KOD CODE | L mm | L inch | g | TL/Ad. |
|--------------|------|--------|-----|--------|
| 3850 12 0200 | 200 | 8" | 360 | 5 |



1000V İZOLELİ ALETLER

1000V INSULATED TOOLS



İZELTAS YOUTUBE

VDE BELGELİ ÜRÜNLERİMİZ / VDE CERTIFIED PRODUCTS



- » El aletleri sektörünün lider markası İZELTAŞ'ın VDE belgeli ürünleri elektrik sektöründe fark yaratıyor.
- Bu ürünler elektrik sektöründe 1000V izolasyon sağlamak için özel olarak tasarlanmış yanmaz sapları ile kullanıcıya güven verir.
 - Elektrik akımının bulunduğu alanlarda güvenli kullanım sağlar.
 - Yanma, 1000V elektrik direnci, soğuk ve sıcak havalarda sap sökme deneyleri başta olmak üzere pek çok özel testten geçirilen ürünler, Alman VDE firmasından onaylıdır.
 - Ergonomik sap tasarımı ile tutuş ve kullanım kolaylığı sağlar.



- » As the leading brand in hand tools sector, CDE certified products of İZELTAŞ make a difference in electrical sector.
- These products assure the user with their handles specially designed to provide isolation up to 1000 V.
 - They provide safe use in areas with electrical current.
 - The products are certified by German VDE institution, being subjected to various tests particularly including fire resistance, 1000 V electrical resistance and handle detachment tests in hot and cold air conditions.
 - They provide ease of grip and use with an ergonomic design.



Çalışma sırasında nelere dikkat edilmelidir?

- Elektrik akımının var olduğu alanlarda yalnızca özel eğitilmiş ve alanında uzman kişiler çalışmalıdır.
- Her kullanım öncesinde VDE belgeli ürünlerde ve izolelerinde hasar olup olmadığı kontrol edilmelidir.
- VDE belgeli ürünler amacı dışında ya da birleştirilerek kullanılmamalıdır.
- VDE belgeli ürünler ile koruyucu ekipmanlarınızı da güvenlik amacıyla kullanmalısınız.



Important points for use

- Only specially trained and expert personnel should engage in work in areas with electrical current.
- Before each use VDE certified products and their isolation materials should be checked against damage.
- VDE certified products should not be used outside their purpose or in combination.
- Protective equipment should also be used to protect personnel in addition to VDE certified products.

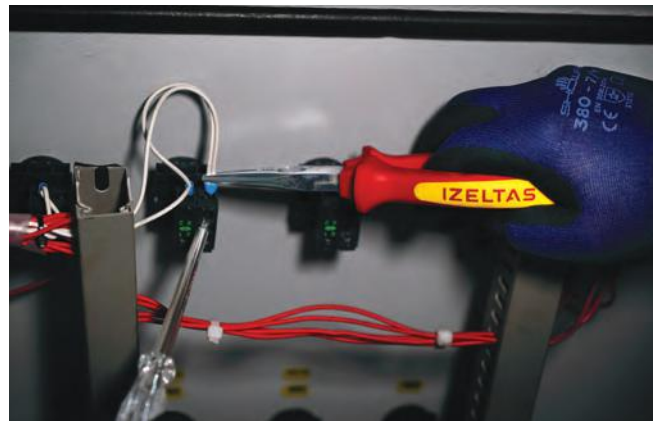

**VDE belgeli ürünlerimiz,
ilgili uluslararası standartlara göre
kontrol edildikten sonra ek olarak
beş ayrı teste tabi tutulur**

**Our VDE certified products
are controlled in accord with the applicable
international standards and then are
subjected to five different tests:**

» 1- Voltaj Testi: 3 dakika boyunca 10.000V'a tabi tutulan izoleli el aletinde kaçak yada elektrik akımı atlama olmamalıdır.

2- Soğuk Şoklama Testi : -24 derece 2 saat bekletilmiş (şoklanmış) el aletine 60-80 cm yükseklikten 600gr ağırlık ile darbeler uygulanır. İzolede kırılma ya da çatlama olmamalıdır.

3- Dayanıklılık Testi: +70 derece 1 hafta bekletilmiş el aletine 50kg yük ile sap sökme testi uygulanır. Sap yerinden çıkmamalıdır.

4- Geçirgenlik Testi: 5000V elektrik akımına karşı 3 dakika boyunca 2kg sivri uçlu ağırlıkta baskı yapılarak elektrik verilir. Kaçak ya da elektrik atlama olmamalıdır.

5- Yanma Testi: Yüksek yoğunluktaki alev 20 saniye maruz bırakılarak teste tabi tutulur. Alevden uzaklaştırılan izole yanmaya devam etmemelidir.

» 1- Voltage Test: No residual current or electrical arc should be seen on the isolated hand tool subjected to 10,000 V for 3 minutes.

2- Cold Shock Test: Hand tools left in -24 °C for 2 hours (shocked) are subjected to impacts with a 600 gr weight dropped from a height of 60-80 cm. No breakage or cracking should be seen on the isolation material.

3- Durability Test: Hand tools left in +70 °C for 1 week are subjected to handle detachment test with a load of 50 kg. The handle should not detach.

4- Perviousness Test: Pointed tips under 2 kg load are used to apply 5000 V electrical current for 3 minutes. There should be no residual current or electrical arc.

5- Fire Test: The tool is subjected to high intensity flames for 20 seconds. After contact with the flame is ended the isolation material should not continue burning.



Güçlü kavrama sağlayan
tırnaklı tutma yüzeyleri
Toothed surface for strong grip

Isıl işlem sonrasında indüksiyonda
sertleştirme ile kullanım
ömrü artırılmış kesici ağızlar
Heat-treated and induction hardened cutting edges for long
lifetime

Nikel üzerine krom kaplama ile
korozyon direncinde
üst seviye koruma
High corrosion resistance
with chrome over nickel plating

Yüksek karbonlu
sıcak dövme çeliği
ile artırılmış
dayanım
High carbon forged steel for
improved durability

VDE/GS belgeli, 1000V dayanımlı,
sert plastikten ve konforlu tutuş
sağlayan yumuşak elastomer
malzemeden imal edilmiş
dayanımı yüksek çift
komponentli ergonomik sap
VDE/GS certified, insulated for 1000V
usage. Two component ergonomic
handle with high strength and
soft grip plastic



İZELTAS YOUTUBE

0255

Süper İzole Çatal Bir Ağız Anahtar (mm)
Single Ended Open Jaw Wrench
Super Insulated (mm)

IEC 60900
 ⚡ 1000 V



Krom vanadyum, Krom kaplı, Kalın PVC izoleli
Chrom vanadium, Chrom plated, Triple PVC insulated

| KOD CODE | mm | L mm | g | | TL/Ad. |
|--------------|----|------|-----|----|--------|
| 0255 01 0010 | 10 | 110 | 40 | 10 | |
| 0255 01 0011 | 11 | 120 | 45 | 10 | |
| 0255 01 0012 | 12 | 130 | 50 | 10 | |
| 0255 01 0013 | 13 | 140 | 60 | 10 | |
| 0255 01 0014 | 14 | 155 | 75 | 10 | |
| 0255 01 0017 | 17 | 170 | 100 | 10 | |
| 0255 01 0019 | 19 | 185 | 150 | 10 | |
| 0255 01 0022 | 22 | 200 | 200 | 10 | |
| 0255 01 0024 | 24 | 220 | 280 | 10 | |

0435

Süper İzoleli Yıldız Bir Ağız Anahtar (mm)
Single Ended Ring Wrench
Super Insulated (mm)

IEC 60900
 ⚡ 1000 V



Krom vanadyum, Krom kaplı, Kalın PVC izoleli
Chrom vanadium, Chrom plated, Triple PVC insulated

| KOD CODE | mm | L mm | g | | TL/Ad. |
|--------------|----|------|-----|----|--------|
| 0435 03 0010 | 10 | 170 | 100 | 10 | |
| 0435 03 0011 | 11 | 175 | 110 | 10 | |
| 0435 03 0012 | 12 | 180 | 130 | 10 | |
| 0435 03 0013 | 13 | 185 | 150 | 10 | |
| 0435 03 0014 | 14 | 190 | 180 | 10 | |
| 0435 03 0017 | 17 | 205 | 220 | 10 | |
| 0435 03 0019 | 19 | 220 | 270 | 10 | |
| 0435 03 0022 | 22 | 245 | 310 | 10 | |
| 0435 03 0024 | 24 | 270 | 420 | 10 | |

2400

1000V İzoleli Üiversal Fort Pense
Insulated Type Waterpump
Pliers Universal 1000V



TS 60
 TS ISO 8976
 IEC 60900
 ⚡ 1000 V



Krom vanadyum, Krom kaplı, çift komponent saplı
Chrom vanadium, Chrom plated, Two component handle

| KOD CODE | L mm | L inch | mm | g | | TL/Ad. |
|--------------|------|--------|----|-----|---|--------|
| 2400 11 6240 | 240 | 9 1/2" | 35 | 370 | 5 | |

3020

1000V İzoleli Elektrikçi Kombine Pense
Insulated Electrician Type
Combination Pliers 1000V



TS 60
 TS ISO 5746
 DIN ISO 5746

⚡ 1000 V
 IEC 60900



Özel alaşımli çelik, Kesici ağızlar induksiyonda sertleştirilmiş, Krom kaplı
Special steel, Cutters induction hardened, Chrom plated



| KOD CODE | L mm | L inch | g | | TL/Ad. |
|--------------|------|--------|-----|---|--------|
| 3020 12 6160 | 160 | 6 1/4" | 205 | 5 | |
| 3020 12 6180 | 180 | 7 1/8" | 260 | 5 | |
| 3020 12 6200 | 200 | 8" | 345 | 5 | |

(★) İşaretili olan ürünler stoklarla sınırlıdır.
Limited with stocks.

1000V İzoleli Elektrikçi Kargaburun Düz Uçlu
Insulated Electrician Type Nose Pliers 1000V



TS 60
TS ISO 5745
DIN ISO 5745
⚡ 1000 V
IEC 60900



Özel alaşımli çelik, Kesici ağızlar indüksiyonda sertleştirilmiş, Krom kaplı
Special steel, Cutters induction hardened, Chrom plated

| KOD CODE | L mm | L inch | g | | TL/Ad. |
|--------------|------|--------|-----|---|--------|
| 3220 13 6140 | 140 | 5 1/2" | 110 | 5 | |
| 3220 13 6160 | 160 | 6 1/4" | 140 | 5 | |
| 3220 13 6180 | 180 | 7 1/8" | 160 | 5 | |
| 3220 13 6200 | 200 | 8" | 170 | 5 | |

1000V İzoleli Elektrikçi Yan Keski
Insulated Electrician Type Side Cutter 1000V



TS 60
TS ISO 5749
DIN ISO 5749
⚡ 1000 V
IEC 60900



Özel alaşımli çelik, Kesici ağızlar indüksiyonda sertleştirilmiş, Krom kaplı
Special steel, Cutters induction hardened, Chrom plated

| KOD CODE | L mm | L inch | g | | TL/Ad. |
|--------------|------|--------|-----|---|--------|
| 3700 16 6140 | 140 | 5 1/2" | 165 | 5 | |
| 3700 16 6160 | 160 | 6 1/4" | 215 | 5 | |
| 3700 16 6180 | 180 | 7 1/8" | 225 | 5 | |

1000V İzoleli Tek Ağızlı Kablo Kesici
Cable Cutter 1000V

⚡ 1000 V
IEC 60900



Özel alaşımli çelik, Kesici ağızlar indüksiyonda sertleştirilmiş
Special steel, Cutters induction hardened

| KOD CODE | L mm | L inch | g | | TL/Ad. |
|--------------|------|--------|-----|---|--------|
| 3715 16 6165 | 165 | 6 1/4" | 150 | 5 | |

1000V İzoleli Elektrikçi Seti (3 Parça)
1000V Insulated Tool Set (3 Pcs)



| KOD CODE | İÇERİK CONTENTS | | TL/Ad. |
|--------------|---|---|--------|
| 3020 12 6160 | 160 mm 1000V İzoleli Elektrikçi Kombine Pense Insulated Electrician Type Combination Pliers | 1 | |
| 3220 13 6160 | 160 mm 1000V İzoleli Elektrikçi Kargaburun Düz Uçlu Insulated Electrician Type Nose Pliers | 1 | |
| 3700 16 6160 | 160 mm 1000V İzoleli Elektrikçi Yan Keski Insulated Electrician Type Side Cutter | 1 | |

(★) İşaretili olan ürünler stoklarla sınırlıdır.
Limited with stocks.

4140

1000V İzoleli Elektrikçi Düz Uçlu Tornavida Insulated Electrician Type Flat Screwdriver 1000V

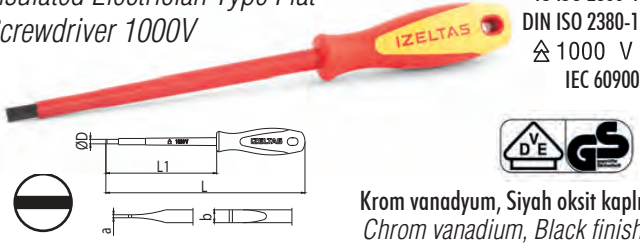

TS 59
TS ISO 2380-1
DIN ISO 2380-1
1000 V
IEC 60900



Krom vanadyum, Siyah oksit kaplı
Chrom vanadium, Black finish

| KOD CODE | ØDxL1 mm | Ø | | L mm | g | TL/Ad. |
|--------------|-------------|---------|---------|---------|----|--------|
| | | a mm | b mm | | | |
| 4140 17 2575 | 2.5x75 | 0.4 | 2.5 | 150 | 25 | 10 |
| 4140 17 4100 | 4x100 | 0.8 | 4 | 185 | 40 | 10 |
| 4140 17 5512 | 5.5x125 | 1 | 5.5 | 220 | 70 | 10 |
| 4140 17 6515 | 6.5x150 | 1.2 | 6.5 | 245 | 90 | 10 |

4145

1000V İzoleli Elektrikçi Yıldız Uçlu Tornavida Insulated Electrician Type Phillips Screwdriver 1000V



TS 59
TS 59-5 ISO 8764
DIN ISO 8764
1000 V
IEC 60900



Krom vanadyum, Siyah oksit kaplı
Chrom vanadium, Black finish

| KOD CODE | ØDxL1 mm | + | L mm | g | TL/Ad. |
|--------------|-------------|-----|---------|----|--------|
| 4145 18 0360 | 3x60 | Ph0 | 135 | 25 | 10 |
| 4145 18 4580 | 4.5x80 | Ph1 | 165 | 45 | 10 |
| 4145 18 6100 | 6x100 | Ph2 | 195 | 70 | 10 |

4140

1000V İzoleli Elektrikçi Tornavida Seti (6 Parça) Insulated Electrician Set (6 Pcs) Screwdriver 1000V



| KOD CODE | İÇERİK CONTENTS | g | TL/Ad. |
|--------------|------------------------|-----|--------|
| 4140 00 9106 | 2.5x75 - 4x100 | 340 | 6 |
| | 5.5x125 - 6.5x150 | | |
| | Düz uçlu / Flat | | |
| | 4.5x80 - 6x100 | | |
| | Yıldız uçlu / Phillips | | |

4773

1000V Süngüsü İzoleli Lokma Uçlu Tornavida Nut Spinner, Electrician Blade Insulated 1000V

DIN 3125

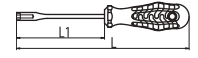

Krom vanadyum, iki komponent saplı
Chrome vanadium, Two component handle

| KOD CODE | Ø mm | L mm | L1 mm | g | TL/Ad. |
|--------------|---------|---------|----------|-----|--------|
| 4773 19 0040 | 4 | 220 | 125 | 90 | 10 |
| 4773 19 0050 | 5 | 220 | 125 | 90 | 10 |
| 4773 19 0055 | 5.5 | 220 | 125 | 90 | 10 |
| 4773 19 0060 | 6 | 220 | 125 | 90 | 10 |
| 4773 19 0070 | 7 | 230 | 125 | 110 | 10 |
| 4773 19 0080 | 8 | 230 | 125 | 120 | 10 |
| 4773 19 0090 | 9 | 230 | 125 | 125 | 10 |
| 4773 19 0100 | 10 | 230 | 125 | 125 | 10 |
| 4773 19 0110 | 11 | 230 | 125 | 140 | 10 |
| 4773 19 0120 | 12 | 230 | 125 | 145 | 10 |
| 4773 19 0130 | 13 | 230 | 125 | 150 | 10 |
| 4773 19 0140 | 14 | 230 | 125 | 150 | 10 |

4773

1000V Süngüsü İzoleli Lokma Uçlu Tornavida Takımı (8 Parça) Nut Spinner, Electrician Blade Insulated Set (8 Pcs) 1000V



| KOD CODE | İÇERİK CONTENTS | g | TL/Ad. |
|--------------|-----------------------------------|------|--------|
| 4773 00 8108 | 6 - 7 - 8 - 9 - 10 - 11 - 12 - 13 | 2225 | 8 |

(*) İşaretili olan ürünler stoklarla sınırlıdır.
Limited with stocks.

1000V Sngs İzoleli Manyetik Bits Tutucu Tornavida
Screwdriver, Magnetic Bit Holder Insulated
1000V

⚡ 1000 V
IEC 60900

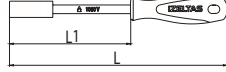

| KOD CODE | Ø mm | L mm | L1 mm | g | TL/Ad. |
|--------------|------|------|-------|-----|--------|
| 4783 19 6120 | 6.3 | 230 | 120 | 115 | 10 |

1000V İzoleli Elektrikçi Seti (5 Parça)
1000V Insulated Tool Set (5 Pcs)



İZELTAS YOUTUBE

| KOD CODE | İÇERİK CONTENTS | TL/Ad. |
|--------------|--|--------|
| 3020 12 6180 | 180 mm 1000V İzoleli Elektrikçi Kombine Pense Insulated Electrician Type Combination Pliers 1000V | 1 |
| 3220 13 6200 | 200 mm 1000V İzoleli Elektrikçi Kargaburun Insulated Electrician Type Nose Pliers | 1 |
| 3700 16 6160 | 160 mm 1000V İzoleli Elektrikçi Yankeski Insulated Electrician Type Nose | 1 |
| 4140 17 5512 | 5.5x125 1000V Elektrikçi Düz Uçlu Tornavida Insulated Electrician Type Flat Screwdriver 1000V | 1 |
| 4145 18 6100 | 6x100 1000V İzoleli Elektrikçi Yıldız Uçlu Tornavida Insulated Electrician Type Phillips Screwdriver 1000V | 1 |

19" Plastik Takım Çantası Elektrikçi Set (23 Parça)
Plastic Tool Box for Electrician 19" (23 Pcs)



| KOD CODE | İÇERİK CONTENTS | TL/Ad. |
|--------------|--|--------|
| 8440 33 1019 | 19" Plastik Takım Çantası Plastic Tool Box | 1 |
| 3700 16 6160 | 160 mm 1000V İzoleli Elektrikçi Yan Keski Insulated Electrician Type Side Cutter 1000V | 1 |
| 3020 12 6180 | 180 mm 1000V İzoleli Elektrikçi Kombine Pense Insulated Electrician Type Combination Pliers 1000V | 1 |
| 3220 13 6160 | 160 mm 1000V İzoleli Elektrikçi Kargaburun Düz Uçlu Insulated Electrician Type Nose Pliers 1000V | 1 |
| 4773 19 0100 | 1000V Sngs İzoleli Lokma Uçlu Tornavida 10mm Nut Spinner, Electrician Blade Insulated 1000V | 1 |
| 4773 19 0130 | 1000V Sngs İzoleli Lokma Uçlu Tornavida 13mm Nut Spinner, Electrician Blade Insulated 1000V | 1 |
| 3715 16 6165 | 165mm 1000V İzoleli Elektrikçi Tek Ağız Kablo Kesici Cable Cutter 1000V | 1 |
| 4520 18 0360 | 3x60 Klemens Yıldız Tornavida Electronic Screwdriver, Phillips | 1 |
| 4520 18 0480 | 4x80 Klemens Yıldız Tornavida Electronic Screwdriver, Phillips | 1 |
| 4500 17 0380 | 3x80 Klemens Düz Tornavida Electronic Screwdriver, Flat | 1 |
| 4500 17 0480 | 4x80 Klemens Düz Tornavida Electronic Screwdriver, Flat | 1 |
| 4140 17 4100 | 4x100 1000V İzoleli Elektrikçi Düz Tornavida Insulated Electrician Type Flat Screwdriver 1000V | 1 |
| 4145 18 4580 | 4,5x80 1000V İzoleli Elektrikçi Yıldız Tornavida Insulated Electrician Type Phillips Screwdriver 1000V | 1 |
| 4145 18 6100 | 6x100 1000V İzoleli Elektrikçi Yıldız Tornavida Insulated Electrician Type Phillips Screwdriver 1000V | 1 |
| 4550 17 0190 | 190 mm Kontrol Kalemi Voltage Tester Flat | 1 |
| 4560 18 0190 | 190 mm Yıldız Kontrol Kalemi Voltage Tester Phillips | 1 |
| 4783 19 6120 | 6.3x120 1000V İzoleli Elektrikçi Manyetik Bits Tutucu Tornavida Screwdriver, Magnetic Bit Holder Insulated 1000V | 1 |
| 4800 00 8106 | 6 lı Bits Set (25 mm) Bit Set 6 Pcs | 6 |

(*) İşaretili olan rnler stoklarla sınırlıdır.
Limited with stocks.



İZELTAS®

TORNAVİDA VE ALLEN ANAHTARLAR

SCREWDRIVERS AND HEX KEY WRENCHES

Tornavidalar
Screwdrivers

Kontrol Kalemleri
Testers

Bits Uçlar ve Aparatları
Bits

Allen Anahtarlar
Hex Key Wrenches

SCREWDRIVERS, HEX KEY
WRENCHES

TORNAVİDALAR
ALLEN
ANAHTARLAR

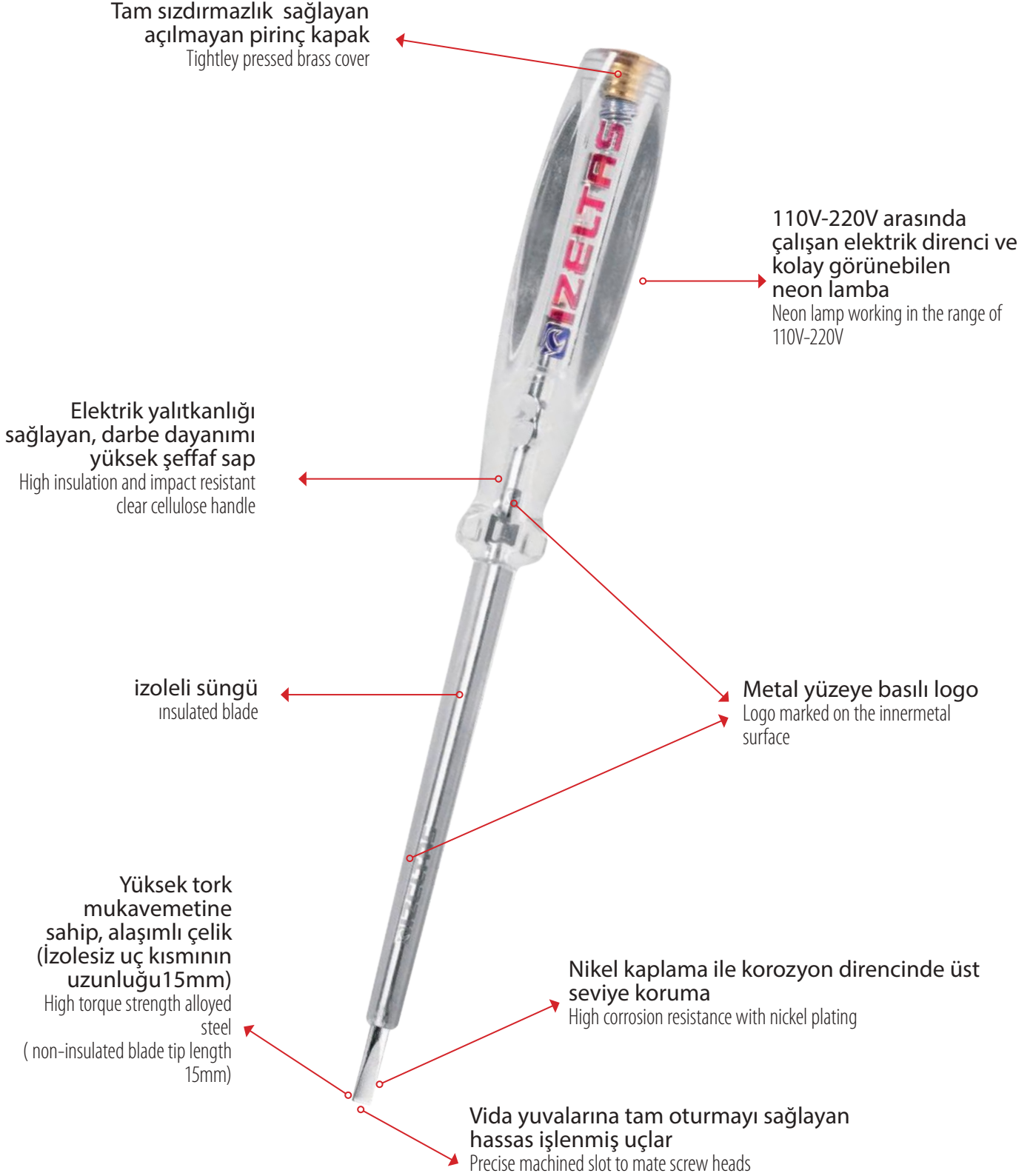

İZELTAS YOUTUBE

ELEKTRİK KONTROL KALEMİ/VOLTAGE TESTER

4550

Elektrik Kontrol Kalemi (Düz Uçlu)
Voltage Tester (Flat)

TS 13108

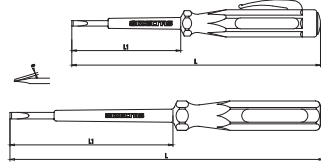

Krom vanadyum, Nikel kaplı,
Chrom vanadium, Nickel plated,

| KOD CODE | L mm | ⊖ | | L1 mm | g | TL/ Ad. |
|--------------|---------|---------|---------|----------|----|------------|
| | | a mm | b mm | | | |
| 4550 17 0135 | 135 | 0.5 | 3 | 60 | 20 | 10 |
| 4550 17 0190 | 190 | 0.8 | 4 | 100 | 40 | 10 |

4555

Master Kontrol Kalemi (Düz Uçlu)
Voltage Tester Master (Flat)

TS 13108

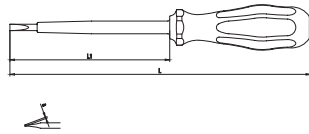

Krom vanadyum, Nikel kaplı
Chrom vanadium, Nickel plated.

| KOD CODE | L mm | ⊖ | | L1 mm | g | TL/ Ad. |
|--------------|---------|---------|---------|----------|----|------------|
| | | a mm | b mm | | | |
| 4555 17 0165 | 165 | 0.5 | 3.5 | 88 | 40 | 10 |

4560

Elektrik Kontrol Kalemi (Yıldız Uçlu)
Voltage Tester Phillips

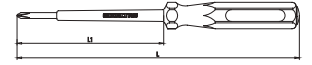
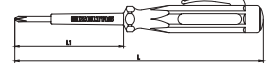

Krom vanadyum, Nikel kaplı
Chrom vanadium, Nickel plated

| KOD CODE | L mm | L1 mm | + | g | TL/ Ad. |
|--------------|---------|----------|-----|----|------------|
| | | | | | |
| 4560 18 0190 | 190 | 100 | Ph0 | 40 | 10 |

4565

Oto Kontrol Kalemi
Car Voltage Tester

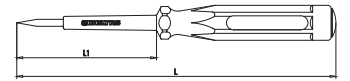

Krom vanadyum, Krom kaplı
Chrom vanadium, Chrom plated

Tüm otomobil ve ağır vasıta araçlarda 6-24V arası elektrik tesisatının kontrol edilmesinde kullanılır. Sivri uçlu olması sebebiyle kablo ve soketleri yerinden sökmeden kontrol kolaylığı sağlar.

Tool is used to control 6-24V electrical wiring in all cars and heavy duty vehicles. With its point tip, wires and sockets are not required to be disassembled.

| KOD CODE | L mm | L1 mm | Kablo L (m) | g | TL/ Ad. |
|-------------|---------|----------|-------------------|---|------------|
| | | | | | |

Kraft Seri Düz Uçlu Tornavida Screwdriver, Kraft, Flat

TS ISO 2380 - 1
DIN ISO 2380-1

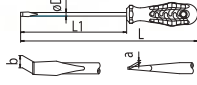

Krom vanadyum, Krom kaplı, Ucu siyah oksit, Selüloz asetat saplı
Chrom vanadium, Chrom plated and black tip,
Cellulose acetate handle

| KOD CODE | øDxL1 mm | ⊖ | | L mm | g | □ | TL/Ad. |
|--------------|-------------|---------|---------|---------|-----|----|--------|
| | | a mm | b mm | | | | |
| 4100 17 0340 | 3x40 | 0.5 | 3 | 105 | 20 | 10 | |
| 4100 17 0380 | 3x80 | 0.5 | 3 | 155 | 35 | 10 | |
| 4100 17 0480 | 4x80 | 0.8 | 4 | 165 | 50 | 10 | |
| 4100 17 4100 | 4x100 | 0.8 | 4 | 185 | 50 | 10 | |
| 4100 17 0580 | 5x80 | 1.0 | 5.5 | 175 | 70 | 10 | |
| 4100 17 5100 | 5x100 | 1.0 | 5.5 | 195 | 75 | 10 | |
| 4100 17 5125 | 5x125 | 1.0 | 5.5 | 220 | 80 | 10 | |
| 4100 17 5150 | 5x150 | 1.0 | 5.5 | 245 | 80 | 10 | |
| 4100 17 6100 | 6x100 | 1.2 | 6.5 | 195 | 85 | 10 | |
| 4100 17 6125 | 6x125 | 1.2 | 6.5 | 220 | 90 | 10 | |
| 4100 17 6150 | 6x150 | 1.2 | 6.5 | 245 | 95 | 10 | |
| 4100 17 6175 | 6x175 | 1.2 | 6.5 | 270 | 100 | 10 | |
| 4100 17 7125 | 7x125 | 1.2 | 8 | 230 | 120 | 10 | |
| 4100 17 7150 | 7x150 | 1.2 | 8 | 255 | 130 | 10 | |
| 4100 17 7175 | 7x175 | 1.2 | 8 | 280 | 135 | 10 | |
| 4100 17 8150 | 8x150 | 1.6 | 10 | 255 | 145 | 10 | |
| 4100 17 8175 | 8x175 | 1.6 | 10 | 280 | 150 | 10 | |
| 4100 17 8200 | 8x200 | 1.6 | 10 | 305 | 160 | 10 | |
| 4100 17 9200 | 9x200 | 2.0 | 12 | 305 | 190 | 10 | |
| 4100 17 1125 | 11x250 | 2.5 | 14 | 365 | 305 | 10 | |



Kraft Seri Düz Uçlu Tornavida Takımı (8 Parça) Screwdriver, Flat, Kraft Set (8 Pcs)



| KOD CODE | İÇERİK CONTENTS | g | □ | TL/Ad. |
|--------------|--|-----|---|--------|
| 4100 00 8108 | 3x80 - 4x80 - 4x100 5x100 - 5x125 - 6x100 6x125 - 6x150 ⊖ Düz uçlu / Flat | 550 | 8 | |

Kraft Seri Süngüsü Uzun Düz Uçlu Tornavida Screwdriver, Kraft, Flat, Long

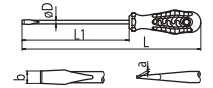

Krom vanadyum, Krom kaplı, Ucu siyah oksit, Selüloz asetat saplı
Chrom vanadium, Chrom plated and black tip,
Cellulose acetate handle

| KOD CODE | øDxL1 mm | ⊖ | | L mm | g | □ | TL/Ad. |
|--------------|-------------|---------|---------|---------|-----|----|--------|
| | | a mm | b mm | | | | |
| 4100 17 4300 | 4x300 | 0.8 | 4 | 385 | 70 | 10 | |
| 4100 17 5250 | 5x250 | 1.0 | 5.5 | 345 | 95 | 10 | |
| 4100 17 5350 | 5x350 | 1.0 | 5.5 | 445 | 115 | 10 | |
| 4100 17 6350 | 6x350 | 1.2 | 6.5 | 445 | 125 | 10 | |

(★) İşaretili olan ürünler stoklarla sınırlıdır.
Limited with stocks.

4120

Kraft Seri Yıldız Uçlu Tornavida
Screwdriver, Kraft, Phillips

TS 59 - 5 ISO 8764-1
DIN ISO 8764-1

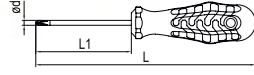

Krom vanadyum, Krom kaplı, Ucu siyah oksit, Selüloz asetat saplı
Chrom vanadium, Chrom plated and black tip,
Cellulose acetate handle.

| KOD CODE | ØdxL1 mm | + | L mm | g | TL/Ad. |
|--------------|----------|-----|------|-----|--------|
| 4120 18 0360 | 3x60 | Ph0 | 135 | 30 | 10 |
| 4120 18 4580 | 4.5x80 | Ph1 | 165 | 55 | 10 |
| 4120 18 5100 | 4.5x100 | Ph1 | 185 | 55 | 10 |
| 4120 18 5150 | 4.5x150 | Ph1 | 235 | 60 | 10 |
| 4120 18 6100 | 6x100 | Ph2 | 195 | 85 | 10 |
| 4120 18 6150 | 6x150 | Ph2 | 245 | 95 | 10 |
| 4120 18 6200 | 6x200 | Ph2 | 295 | 105 | 10 |
| 4120 18 8150 | 8x150 | Ph3 | 255 | 150 | 10 |
| 4120 18 1200 | 10x200 | Ph4 | 315 | 240 | 10 |

4120

Kraft Seri Süngüsü Uzun Yıldız Uçlu Tornavida
Screwdriver, Kraft, Phillips, Long

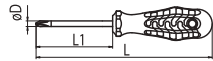

Krom vanadyum, Krom kaplı, Ucu siyah oksit, Selüloz asetat saplı
Chrom vanadium, Chrom plated and black tip,
Cellulose acetate handle

| KOD CODE | ØDxL1 mm | + | L mm | g | TL/Ad. |
|--------------|----------|-----|------|-----|--------|
| 4120 18 5300 | 4.5x300 | Ph1 | 385 | 80 | 10 |
| 4120 18 6300 | 6x300 | Ph2 | 395 | 125 | 10 |

4120

Kraft Seri Yıldız Uçlu Tornavida Takımı (6 parça)
Screwdriver, Kraft, Phillips, Set (6 Pcs)



| KOD CODE | İÇERİK CONTENTS | g | TL/Ad. |
|--------------|---|-----|--------|
| 4120 00 8106 | 3x60 - 4.5x80 4.5x100 - 4.5x150 6x100 - 6x150 Yıldız uçlu / Phillips | 380 | 6 |

4100

Kraft Seri Tornavida Seti (7 parça)
Screwdriver Set, Kraft (7 Pcs)



| KOD CODE | İÇERİK CONTENTS | g | TL/Ad. |
|--------------|---|-----|--------|
| 4100 00 8107 | 3x80 - 4x80 - 4x100 5x125 - 6x150 Düz uçlu / Flat 4.5x80 - 6x100 Yıldız uçlu / Phillips | 445 | 7 |

(★) İşaretili olan ürünler stoklarla sınırlıdır.
Limited with stocks.

Kraft Seri Düz Uçlu Topaç Tornavida
Screwdriver, Kraft, Stubby, Flat

TS 59

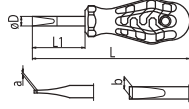

Krom vanadyum, Krom kaplı, Ucu siyah oksit, Selüloz asetat saplı
Chrom vanadium, Chrom plated and black tip,
Cellulose acetate handle

| KOD CODE | ØDxL1 mm | - | | L mm | g | TL/Ad. |
|--------------|-------------|---------|---------|---------|----|--------|
| | | a mm | b mm | | | |
| 4110 17 5525 | 5.5x25 | 1 | 5.5 | 70 | 30 | 5 |
| 4110 17 5540 | 5.5x40 | 1 | 5.5 | 105 | 45 | 5 |
| 4110 17 6525 | 6.5x25 | 1.2 | 6.5 | 70 | 35 | 5 |
| 4110 17 6540 | 6.5x40 | 1.2 | 6.5 | 105 | 50 | 5 |

Kraft Seri Yıldız Uçlu Topaç Tornavida
Screwdriver, Kraft, Stubby, Phillips

TS 59 -5

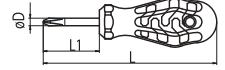

Krom vanadyum, Krom kaplı, Ucu siyah oksit, Selüloz asetat saplı
Chrom vanadium, Chrom plated and black tip,
Cellulose acetate handle

| KOD CODE | ØDxL1 mm | + | L mm | g | TL/Ad. |
|--------------|-------------|-----|---------|----|--------|
| | | | | | |
| 4130 18 4540 | 4.5x40 | Ph1 | 105 | 40 | 5 |
| 4130 18 0625 | 6x25 | Ph2 | 70 | 30 | 5 |
| 4130 18 0640 | 6x40 | Ph2 | 105 | 50 | 5 |



4140

1000V İzoleli Elektrikçi Düz Uçlu Tornavida Insulated Electrician Type Flat Screwdriver 1000V

TS 59
TS ISO 2380-1
DIN ISO 2380-1
⚡ 1000 V
IEC 60900

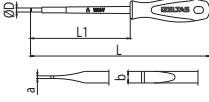

Krom vanadyum, Siyah oksit kaplı
Chrom vanadium, Black finish

| KOD CODE | øDxL1 mm | ⊖ | | L mm | g | TL/Ad. |
|--------------|-------------|---------|---------|---------|----|--------|
| | | a mm | b mm | | | |
| 4140 17 2575 | 2.5x75 | 0.4 | 2.5 | 150 | 25 | 10 |
| 4140 17 4100 | 4x100 | 0.8 | 4 | 185 | 40 | 10 |
| 4140 17 5512 | 5.5x125 | 1 | 5.5 | 220 | 70 | 10 |
| 4140 17 6515 | 6.5x150 | 1.2 | 6.5 | 245 | 90 | 10 |

4140

1000V İzoleli Elektrikçi Tornavida Seti (6 Parça) Insulated Electrician Set (6 Pcs) Screwdriver 1000V



| KOD CODE | İÇERİK CONTENTS | g | TL/Ad. |
|--------------|------------------------|-----|--------|
| 4140 00 9106 | 2.5x75 - 4x100 | 340 | 6 |
| | ⊖ 5.5x125 - 6.5x150 | | |
| | Düz uçlu / Flat | | |
| | ⊕ 4.5x80 - 6x100 | | |
| | Yıldız uçlu / Phillips | | |

4145

1000V İzoleli Elektrikçi Yıldız Uçlu Tornavida Insulated Electrician Type Phillips Screwdriver 1000V

TS 59
TS 59-5ISO 8764
DIN ISO 8764
⚡ 1000 V
IEC 60900

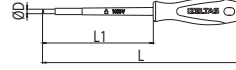

Krom vanadyum, Siyah oksit kaplı
Chrom vanadium, Black finish

| KOD CODE | øDxL1 mm | ⊕ | L mm | g | TL/Ad. |
|--------------|-------------|-----|---------|----|--------|
| 4145 18 0360 | 3x60 | Ph0 | 135 | 25 | 10 |
| 4145 18 4580 | 4.5x80 | Ph1 | 165 | 45 | 10 |
| 4145 18 6100 | 6x100 | Ph2 | 195 | 70 | 10 |



Opak Seri Düz Uçlu Tornavida Screwdriver, Opak, Flat

TS ISO 2380-1
DIN ISO 2380-1

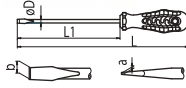

Krom vanadyum, Krom kaplı, Ucu siyah oksit, PP saplı
Chrome vanadium, Chrom plated and black tip, PP handle

| KOD CODE | ØDxL1 mm | ⊖ | | L mm | g | □ | TL/Ad. |
|--------------|-------------|---------|---------|---------|-----|----|--------|
| | | a mm | b mm | | | | |
| 4300 17 0380 | 3x80 | 0.5 | 3 | 155 | 25 | 10 | |
| 4300 17 0480 | 4x80 | 0.8 | 4 | 165 | 35 | 10 | |
| 4300 17 4100 | 4x100 | 0.8 | 4 | 185 | 40 | 10 | |
| 4300 17 5100 | 5x100 | 1.0 | 5.5 | 195 | 60 | 10 | |
| 4300 17 5125 | 5x125 | 1.0 | 5.5 | 220 | 60 | 10 | |
| 4300 17 6100 | 6x100 | 1.2 | 6.5 | 195 | 65 | 10 | |
| 4300 17 6125 | 6x125 | 1.2 | 6.5 | 220 | 70 | 10 | |
| 4300 17 6150 | 6x150 | 1.2 | 6.5 | 245 | 80 | 10 | |
| 4300 17 7125 | 7x125 | 1.2 | 8 | 230 | 95 | 10 | |
| 4300 17 7150 | 7x150 | 1.2 | 8 | 255 | 105 | 10 | |
| 4300 17 8175 | 8x175 | 1.6 | 10 | 280 | 130 | 10 | |
| 4300 17 9200 | 9x200 | 2.0 | 12 | 305 | 165 | 10 | |

Opak Seri Yıldız Uçlu Tornavida Screwdriver, Opak, Phillips

TS 59 - 5 ISO 8764-1
DIN ISO 8764

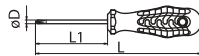

Krom vanadyum, Krom kaplı, Ucu siyah oksit, PP saplı
Chrome vanadium, Chrom plated and black tip, PP handle

| KOD CODE | ØDxL1 mm | + | L mm | g | □ | TL/Ad. |
|--------------|-------------|-----|---------|-----|----|--------|
| 4320 18 0360 | 3x60 | Ph0 | 135 | 25 | 10 | |
| 4320 18 4580 | 4.5x80 | Ph1 | 165 | 40 | 10 | |
| 4320 18 6100 | 6x100 | Ph2 | 195 | 70 | 10 | |
| 4320 18 8150 | 8x150 | Ph3 | 255 | 140 | 10 | |

Opak Seri Tornavida Seti (7 Parça) Screwdriver Set, Opak (7 Pcs)



| KOD CODE | İÇERİK CONTENTS | g | □ | TL/Ad. |
|--------------|-------------------------------|-----|---|--------|
| 4300 00 8107 | 3x80 - 4x80 - 4x100 | 520 | 7 | |
| | 5x125 - 6x150 | | | |
| | Düz uçlu / Flat | | | |
| | 4.5x80 - 6x100 | | | |
| | Yıldız uçlu / Phillips | | | |

Opak Seri Pozidriv Yıldız Uçlu Tornavida Screwdriver, Opak, Pozidriv

DIN ISO 8764

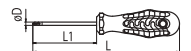

Krom vanadyum, Krom kaplı, Ucu siyah oksit, PP saplı
Chrome vanadium, Chrom plated and black tip, PP handle

| KOD CODE | ØDxL1 mm | + | L mm | g | □ | TL/Ad. |
|--------------|-------------|-----|---------|-----|----|--------|
| 4325 18 0360 | 3x60 | Pz0 | 135 | 25 | 10 | |
| 4325 18 4580 | 4.5x80 | Pz1 | 165 | 40 | 10 | |
| 4325 18 6100 | 6x100 | Pz2 | 195 | 70 | 10 | |
| 4325 18 8150 | 8x150 | Pz3 | 255 | 140 | 10 | |

(★) İşaretili olan ürünler stoklarla sınırlıdır.
Limited with stocks.

★4350

Ergonomik Seri Düz Uçlu Tornavida Screwdriver, Ergonomic, Flat

TS ISO 2380-1
DIN ISO 2380-1

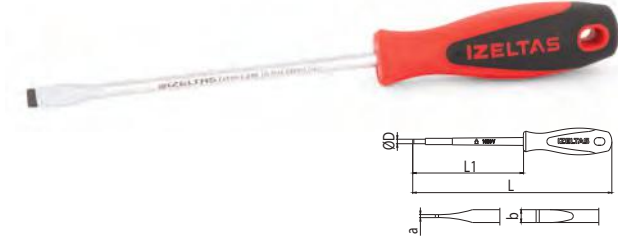

Krom vanadyum, Krom kaplı, Ucu siyah oksit, İki komponent saplı
Chrome vanadium, Chrom plated and black tip,
Two component handle.

| KOD CODE | ØDxL1 mm | ⊖ | | L mm | g | TL/Ad. |
|---------------|-------------|---------|---------|---------|-----|--------|
| | | a mm | b mm | | | |
| ★4350 17 0380 | 3x80 | 0.5 | 3 | 155 | 25 | 10 |
| ★4350 17 0480 | 4x80 | 0.8 | 4 | 165 | 40 | 10 |
| ★4350 17 4100 | 4x100 | 0.8 | 4 | 185 | 40 | 10 |
| ★4350 17 5100 | 5x100 | 1.0 | 5.5 | 195 | 60 | 10 |
| ★4350 17 5125 | 5x125 | 1.0 | 5.5 | 220 | 65 | 10 |
| ★4350 17 6100 | 6x100 | 1.2 | 6.5 | 195 | 70 | 10 |
| ★4350 17 6125 | 6x125 | 1.2 | 6.5 | 220 | 75 | 10 |
| ★4350 17 6150 | 6x150 | 1.2 | 6.5 | 245 | 80 | 10 |
| ★4350 17 7125 | 7x125 | 1.2 | 8 | 230 | 100 | 10 |
| ★4350 17 7150 | 7x150 | 1.2 | 8 | 255 | 110 | 10 |
| ★4350 17 8175 | 8x175 | 1.6 | 10 | 280 | 140 | 10 |
| ★4350 17 9200 | 9x200 | 2 | 12 | 305 | 180 | 10 |

★4350

Ergonomik Seri Tornavida Seti (7 Parça) Screwdriver Set, Ergonomic (7 Pcs.)



| KOD CODE | İÇERİK CONTENTS | g | TL/ Ad. |
|---------------|---|-----|------------|
| ★4350 00 8107 | 3x80 - 4x80 - 4x100 ⊖ 5x125 - 6x150 Düz uçlu / Flat ⊕ 4.5x80 - 6x100 Yıldız uçlu / Phillips | 370 | 7 |

★4370

Ergonomik Seri Yıldız Uçlu Tornavida Screwdriver, Ergonomic, Phillips

TS 59 - 5 ISO 8764-1
DIN ISO 8764-1

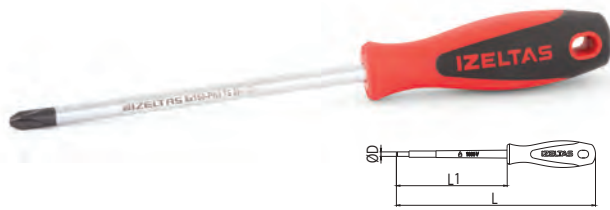

Krom vanadyum, Krom kaplı, Ucu siyah oksit, İki komponent saplı
Chrome vanadium, Chrom plated and black tip,
Two component handle.

| KOD CODE | ØDxL1 mm | ⊕ | L mm | g | TL/Ad. |
|---------------|-------------|-----|---------|-----|--------|
| ★4370 18 0360 | 3x60 | Ph0 | 135 | 25 | 10 |
| ★4370 18 4580 | 4.5x80 | Ph1 | 165 | 45 | 10 |
| ★4370 18 6100 | 6x100 | Ph2 | 195 | 70 | 10 |
| ★4370 18 8150 | 8x150 | Ph3 | 255 | 130 | 10 |



(★) İşaretili olan ürünler stoklarla sınırlıdır.
Limited with stocks.

4240

Değişken Uçlu Tornavida Screwdriver - Reversible

TSEK



Krom vanadyum, Krom kaplı, Selüloz asetat saplı
Chrom vanadium, Chrom plated, Cellulose acetate handle

| KOD CODE | øDxL1 mm | - | | L mm | g | TL/Ad. |
|--------------|-------------|---------|---------|---------|----|--------|
| | | a mm | b mm | | | |
| 4240 17 0680 | 6x80 | 1.2x6 | Ph2 | 175 | 80 | 10 |

4240

Değişken Uçlu Tornavida Takımı Screwdriver Set - Reversible

TSEK



| KOD CODE | øDxL1 mm | - | | L mm | g | TL/Ad. |
|--------------|-------------|----------|---------|---------|-----|--------|
| | | a mm | b mm | | | |
| 4240 00 7102 | 6x80 | 1.2x6 | Ph2 | 175 | 105 | 1 |
| | 4.5x80 | 0.65x4.5 | Ph1 | | | |

4500

Elektronikçi Tip (Klemens) Düz Uçlu Tornavida Electronic Screwdriver, Flat



Krom vanadyum, Krom kaplı, Ucu siyah oksit, PP saplı
Chrome vanadium, Chrom plated and black tip, PP handle

| KOD CODE | øDxL1 mm | - | | L mm | g | TL/Ad. |
|--------------|-------------|---------|---------|---------|----|--------|
| | | a mm | b mm | | | |
| 4500 17 2560 | 2.5x60 | 0.4 | 2.5 | 140 | 15 | 10 |
| 4500 17 2580 | 2.5x80 | 0.4 | 2.5 | 160 | 15 | 10 |
| 4500 17 0380 | 3x80 | 0.5 | 3 | 160 | 15 | 10 |
| 4500 17 3100 | 3x100 | 0.5 | 3 | 180 | 20 | 10 |
| 4500 17 3125 | 3x125 | 0.5 | 3 | 205 | 20 | 10 |
| 4500 17 3510 | 3.5x100 | 0.6 | 3.5 | 180 | 20 | 10 |
| 4500 17 0480 | 4x80 | 0.8 | 4 | 160 | 20 | 10 |
| 4500 17 4100 | 4x100 | 0.8 | 4 | 180 | 20 | 10 |
| 4500 17 4125 | 4x125 | 0.8 | 4 | 205 | 25 | 10 |
| 4500 17 4150 | 4x150 | 0.8 | 4 | 230 | 25 | 10 |

4520

Elektronikçi Tip (Klemens) Yıldız Uçlu Tornavida Electronic Screwdriver, Phillips



Krom vanadyum, Krom kaplı, Ucu siyah oksit, PP saplı
Chrome vanadium, Chrom plated and black tip, PP handle

| KOD CODE | øDxL1 mm | + | L mm | g | TL/Ad. |
|--------------|-------------|-----|---------|----|--------|
| 4520 18 0360 | 3x60 | Ph0 | 140 | 15 | 10 |
| 4520 18 0480 | 4x80 | Ph0 | 160 | 20 | 10 |
| 4520 18 4150 | 4x150 | Ph0 | 230 | 25 | 10 |

4500

Elektronikçi Tip (Klemens) Tornavida Seti (6 Parça) Electronic Screwdriver Set (6 Pcs)



| KOD CODE | İÇERİK CONTENTS | g | TL/Ad. |
|--------------|--|-----|--------|
| 4500 00 8106 | 3x80 - 3x100 3x125 - 4x150 Düz uçlu / Flat | 115 | 6 |
| | 3x60 - 4x80 Yıldız uçlu / Phillips | | |

4530

Elektronikçi Tip (Klemens) Torx® Uçlu Tornavida Electronic Screwdriver, Torx®

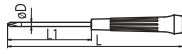

Krom vanadyum, Krom kaplı, Ucu siyah oksit, PP saplı
Chrome vanadium, Chrom plated and black tip, PP handle

| KOD CODE | ØDxL1 mm | ★ | L mm | g | TL/Ad. |
|--------------|----------|-----|------|----|--------|
| 4530 17 0560 | 2.5x60 | T5 | 145 | 15 | 10 |
| 4530 17 0660 | 2.5x60 | T6 | 145 | 15 | 10 |
| 4530 17 0760 | 3x60 | T7 | 145 | 15 | 10 |
| 4530 17 0860 | 3x60 | T8 | 145 | 20 | 10 |
| 4530 17 0960 | 3x60 | T9 | 145 | 20 | 10 |
| 4530 17 1060 | 3.5x60 | T10 | 145 | 20 | 10 |

4530

Elektronikçi Tip (Klemens) Torx® Uçlu Tornavida Takımı (6 Parça) Electronic Screwdriver Set Torx (6 Pcs)



| KOD CODE | İÇERİK CONTENTS | g | TL/Ad. |
|--------------|------------------------------|-----|--------|
| 4530 00 1006 | T5 - T6 - T7 - T8 - T9 - T10 | 115 | 6 |

4540

Klips Sökme Tornavidası Hupcap and Clip Remover

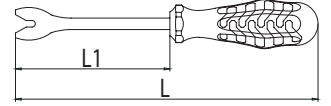

Krom vanadyum, Krom kaplı, PP Saplı
Chrom vanadium, Chrom plated, PP insulated

| KOD CODE | L mm | L1 | g | TL/Ad. |
|--------------|------|-----|-----|--------|
| 4540 19 0190 | 290 | 180 | 160 | 10 |

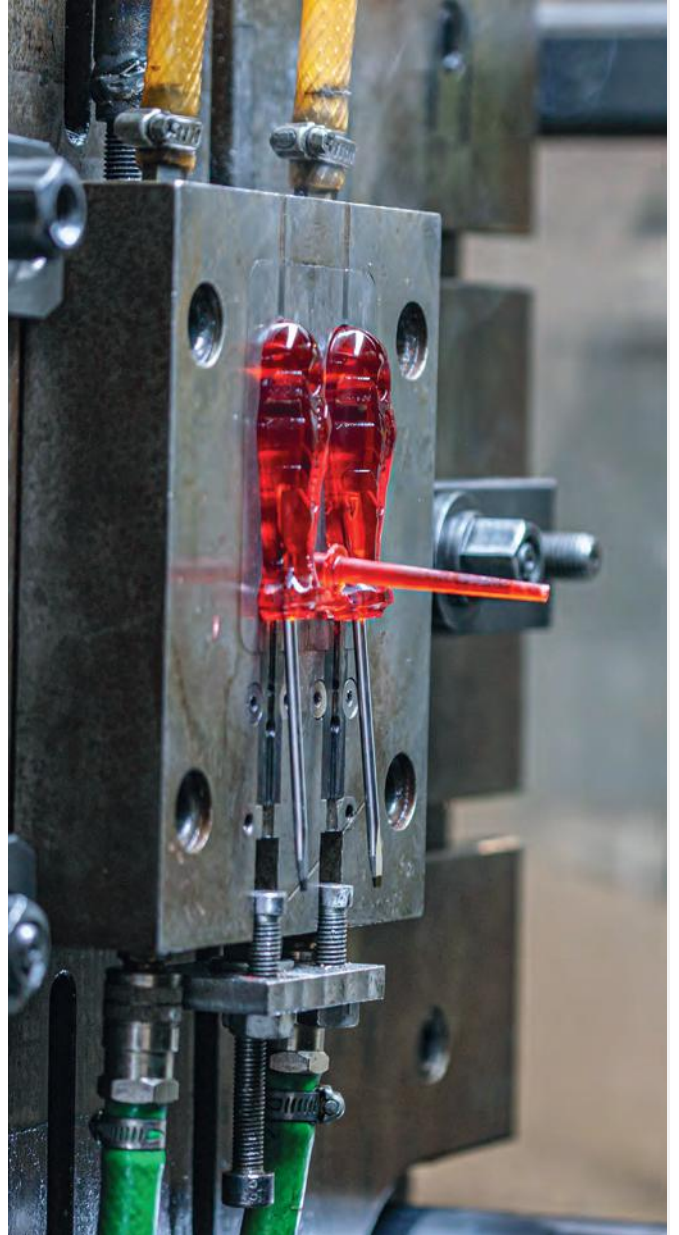

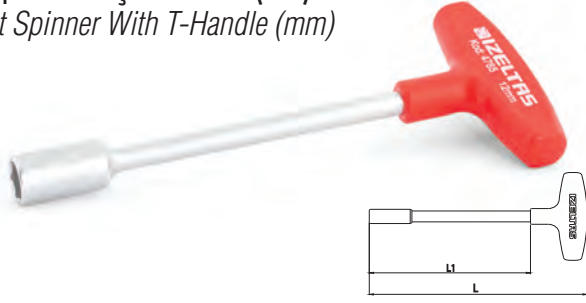
T Tipi Lokma Uçlu Tornavida (mm)
Nut Spinner With T-Handle (mm)

Krom vanadyum, Krom kaplı, PP Saplı
Chrom vanadium, Chrom plated, PP insulated

| KOD CODE | mm | L mm | L1 mm | g | TL/Ad. |
|--------------|-----|------|-------|-----|--------|
| 4765 19 0040 | 4 | 185 | 135 | 75 | 10 |
| 4765 19 0050 | 5 | 185 | 135 | 75 | 10 |
| 4765 19 0055 | 5.5 | 185 | 135 | 75 | 10 |
| 4765 19 0060 | 6 | 185 | 135 | 75 | 10 |
| 4765 19 0070 | 7 | 185 | 135 | 90 | 10 |
| 4765 19 0080 | 8 | 185 | 135 | 95 | 10 |
| 4765 19 0090 | 9 | 185 | 135 | 100 | 10 |
| 4765 19 0100 | 10 | 185 | 135 | 100 | 10 |
| 4765 19 0110 | 11 | 185 | 135 | 110 | 10 |
| 4765 19 0120 | 12 | 185 | 135 | 110 | 10 |
| 4765 19 0130 | 13 | 185 | 135 | 115 | 10 |
| 4765 19 0140 | 14 | 185 | 135 | 115 | 10 |

Lokma Uçlu Tornavida (mm)
Nut Spinner (mm)

DIN 3125



Krom vanadyum, Krom kaplı, PP Saplı
Chrom vanadium, Chrom plated, PP insulated

| KOD CODE | mm | L mm | L1 mm | g | TL/Ad. |
|--------------|-----|------|-------|-----|--------|
| 4770 19 0040 | 4 | 220 | 125 | 80 | 10 |
| 4770 19 0050 | 5 | 220 | 125 | 80 | 10 |
| 4770 19 0055 | 5.5 | 220 | 125 | 80 | 10 |
| 4770 19 0060 | 6 | 220 | 125 | 80 | 10 |
| 4770 19 0070 | 7 | 230 | 125 | 100 | 10 |
| 4770 19 0080 | 8 | 230 | 125 | 110 | 10 |
| 4770 19 0090 | 9 | 230 | 125 | 115 | 10 |
| 4770 19 0100 | 10 | 230 | 125 | 115 | 10 |
| 4770 19 0110 | 11 | 230 | 125 | 130 | 10 |
| 4770 19 0120 | 12 | 230 | 125 | 135 | 10 |
| 4770 19 0130 | 13 | 230 | 125 | 140 | 10 |
| 4770 19 0140 | 14 | 230 | 125 | 140 | 10 |

Lokma Uçlu Tornavida Takımı (8 Parça, mm)
Nut Spinner Set (8 Pcs, mm)



| KOD CODE | İÇERİK CONTENTS | g | TL/Ad. |
|--------------|------------------------------------|------|--------|
| 4770 00 8108 | 6 - 7 - 8 - 9 - 10 11 - 12 - 13 | 2145 | 8 |

(★) İşaretili olan ürünler stoklarla sınırlıdır.
Limited with stocks.

4773

1000V Süngüsü İzoleli Lokma Uçlu Tornavida
Nut Spinner, Electrician Blade Insulated 1000V

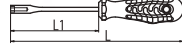
DIN 3125



Krom vanadyum, İki Komponent Saplı
Chrome vanadium, Two Component Insulated

| KOD CODE | mm | L mm | L1 mm | g | TL/Ad. |
|--------------|-----|------|-------|-----|--------|
| 4773 19 0040 | 4 | 220 | 125 | 90 | 10 |
| 4773 19 0050 | 5 | 220 | 125 | 90 | 10 |
| 4773 19 0055 | 5.5 | 220 | 125 | 90 | 10 |
| 4773 19 0060 | 6 | 220 | 125 | 90 | 10 |
| 4773 19 0070 | 7 | 230 | 125 | 110 | 10 |
| 4773 19 0080 | 8 | 230 | 125 | 120 | 10 |
| 4773 19 0090 | 9 | 230 | 125 | 125 | 10 |
| 4773 19 0100 | 10 | 230 | 125 | 125 | 10 |
| 4773 19 0110 | 11 | 230 | 125 | 140 | 10 |
| 4773 19 0120 | 12 | 230 | 125 | 145 | 10 |
| 4773 19 0130 | 13 | 230 | 125 | 150 | 10 |
| 4773 19 0140 | 14 | 230 | 125 | 150 | 10 |

4773

1000V Süngüsü İzoleli Lokma Uçlu Tornavida Takımı (8 Parça)
Nut Spinner, Electrician Blade Insulated Set (8 Pcs)
1000V



| KOD CODE | İÇERİK CONTENTS | g | TL/Ad. |
|--------------|-----------------------------------|------|--------|
| 4773 00 8108 | 6 - 7 - 8 - 9 - 10 - 11 - 12 - 13 | 2225 | 8 |

4775

Torx® Uçlu Tornavida
Torx® Screwdriver

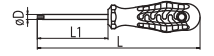

Krom vanadyum, Krom kaplı, Ucu siyah oksit, PP saplı
Chrome vanadium, Chrom plated and blackened, PP handle

| KOD CODE | σDxL1 mm | ☆ | L mm | g | TL/Ad. |
|--------------|----------|-----|------|-----|--------|
| 4775 18 0010 | 4x80 | T10 | 165 | 35 | 10 |
| 4775 18 0015 | 4x80 | T15 | 165 | 35 | 10 |
| 4775 18 0020 | 4x100 | T20 | 185 | 40 | 10 |
| 4775 18 0025 | 4.5x100 | T25 | 185 | 40 | 10 |
| 4775 18 0027 | 5x125 | T27 | 220 | 60 | 10 |
| 4775 18 0030 | 6x125 | T30 | 220 | 70 | 10 |
| 4775 18 0040 | 7x125 | T40 | 230 | 100 | 10 |
| 4775 18 0045 | 8x125 | T45 | 230 | 120 | 10 |

4775

Torx® Uçlu Tornavida Takımı (7 Parça)
Torx® Screwdriver Set (7 Pcs)



| KOD CODE | İÇERİK CONTENTS | g | TL/Ad. |
|--------------|---|-----|--------|
| 4775 00 8107 | T10 - T15 - T20 - T25 - T27 - T30 - T40 | 380 | 7 |

4776

Delikli Torx® Uçlu Tornavida
Torx® Screwdriver / Tamper Resistance

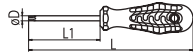

Krom vanadyum, Krom kaplı, Ucu siyah oksit, PP saplı
Chrome vanadium, Chrom plated and blackened, PP handle

| KOD CODE | ØDxL1 mm | ☆ | L mm | g | TL/Ad. |
|--------------|----------|------|------|-----|--------|
| 4776 18 0009 | 4x60 | TR9 | 145 | 35 | 10 |
| 4776 18 0010 | 4x80 | TR10 | 165 | 35 | 10 |
| 4776 18 0015 | 4x80 | TR15 | 165 | 40 | 10 |
| 4776 18 0020 | 4x100 | TR20 | 185 | 40 | 10 |
| 4776 18 0025 | 4.5x100 | TR25 | 185 | 45 | 10 |
| 4776 18 0027 | 5x125 | TR27 | 220 | 60 | 10 |
| 4776 18 0030 | 6x125 | TR30 | 220 | 70 | 10 |
| 4776 18 0040 | 7x125 | TR40 | 230 | 100 | 10 |

4776

Delikli Torx® Uçlu Tornavida Takımı (7 Parça)
Torx® Screwdriver / Tamper Resistance Set (7 Pcs)



| KOD CODE | İÇERİK CONTENTS | g | TL/Ad. |
|--------------|---|-----|--------|
| 4776 00 8107 | TR10 - TR15 - TR20 - TR25 - TR27 TR30 - TR40 | 380 | 7 |

4780

Manyetik Bits Tutucu Tornavida (Uzun)
Screwdriver, Magnetic Bit Holder (Long)



| KOD CODE | mm | L mm | L1 mm | g | TL/Ad. |
|--------------|-----|------|-------|-----|--------|
| 4780 19 6120 | 6.3 | 230 | 120 | 105 | 10 |

4783

1000V Süngüsü İzoleli Manyetik Bits Tutucu Tornavida
Screwdriver, Magnetic Bit Holder Insulated
1000V

⚡ 1000 V
IEC 60900



| KOD CODE | mm | L mm | L1 mm | g | TL/Ad. |
|--------------|-----|------|-------|-----|--------|
| 4783 19 6120 | 6.3 | 230 | 120 | 115 | 10 |

4785

Manyetik Bits Tutucu Tornavida (Kısa)
Screwdriver, Magnetic Bit Holder, (Short)



| KOD CODE | mm | L mm | L1 mm | g | TL/Ad. |
|--------------|-----|------|-------|----|--------|
| 4785 19 6330 | 6.3 | 130 | 30 | 60 | 10 |

4790

Üniversal Bits Adaptörü (Manyetik)
Screwdriver Universal Bit Holder (Magnetic)



| KOD CODE | mm | mm | L mm | g | TL/Ad. |
|--------------|-----|-----|------|----|--------|
| 4790 26 6360 | 6.3 | 6.3 | 60 | 25 | 10 |

(★) İşaretili olan ürünler stoklarla sınırlıdır.
Limited with stocks.

4795

T Tipi Manyetik Bits Tutucu Tornavida Magnetic Bit Holder With T-Handle



| KOD CODE | mm | L mm | L1 mm | g | TL/Ad. |
|--------------|-----|------|-------|----|--------|
| 4795 19 0010 | 6.3 | 180 | 130 | 60 | 10 |

4788

Manyetik Bits Tutucu Tornavida, Flexible Screwdriver, Magnetic Bit Holder, Flexible



| KOD CODE | mm | L mm | L1 mm | g | TL/Ad. |
|--------------|-----|------|-------|-----|--------|
| 4788 19 6160 | 6.3 | 285 | 175 | 130 | 10 |

4805

Bits Uç Lokma Adaptörü (Makine Kullanımına Uygun) Socket Adapter



| KOD CODE | mm | L mm | g | TL/Ad. |
|--------------|---------------|------|----|--------|
| 4805 20 5010 | 1/4"M - 1/4"M | 50 | 20 | 10 |
| 4805 20 5011 | 1/4"M - 1/2"M | 50 | 25 | 10 |

4815

Değişken Bits Uçlu Tornavida Set (7 parça) Screwdriver - Interchangeable Bits Set (7 pcs)



| KOD CODE | İÇERİK CONTENTS | g | TL/Ad. |
|--------------|---|-----|--------|
| 4815 00 6107 | 100mm Sap Ph1x4.5 - Ph2x5.5 - Ph3x7 Pz1x4.5 - Pz2x5.5 - Pz3x7 | 140 | 7 |

4800

6'lı Bits Set Bit Set (6 Pcs)



| KOD CODE | İÇERİK CONTENTS | g | TL/Ad. |
|--------------|-------------------|----|--------|
| 4800 00 8106 | 0.6x4.5 - 0.8x5.5 | 50 | 6 |
| | Ph1 - Ph2 - Ph3 | | |
| | T27 | | |

4800

10'lu Bits Set Bit Set (10 Pcs)



| KOD CODE | İÇERİK CONTENTS | g | TL/Ad. |
|--------------|------------------------------|----|--------|
| 4800 00 8110 | 0.6x4.5 - 0.8x5.5 1.2x6.5 | 55 | 10 |
| | Ph1 - Ph2 - Ph3 | | |
| | T25 - T27 - T30 - T40 | | |

4800

31'li Bits Set (Plastik Kutulu) Bit Set In Plastic Case (31 Pcs)



| KOD CODE | İÇERİK CONTENTS | g | TL/Ad. |
|--------------|-------------------|-----|--------|
| 4800 00 8131 | 0.6x4.5 - 0.8x5.5 | 385 | 3 - 3 |
| | 1.2x6.5 | | 4 |
| | Ph1 | | 3 |
| | Ph2 - Ph3 | | 6 - 6 |
| | T27 | | 2 |
| | T25 - T30 - T40 | | 1-1-1 |
| | 6.3 x 60 Adaptör | | 1 |

(*) İşaretli olan ürünler stoklarla sınırlıdır.
Limited with stocks.

Düz Bits Uçlar

Bits Flat

25mm-50mm-75mm-100mm-150mm



Krom vanadyum
Chrom vanadium

| KOD CODE | ⊖ | L mm | g | TL/Ad. |
|--------------|---------|------|----|--------|
| 4810 20 0645 | 0.6x4.5 | 25 | 5 | 10 |
| 4810 20 0855 | 0.8x5.5 | 25 | 5 | 10 |
| 4810 20 1265 | 1.2x6.5 | 25 | 5 | 10 |
| 4810 20 5645 | 0.6x4.5 | 50 | 10 | 10 |
| 4810 20 5855 | 0.8x5.5 | 50 | 10 | 10 |
| 4810 20 5265 | 1.2x6.5 | 50 | 10 | 10 |
| 4860 20 0745 | 0.6x4.5 | 75 | 11 | 10 |
| 4860 20 0755 | 0.8x5.5 | 75 | 13 | 10 |
| 4860 20 0765 | 1.2x6.5 | 75 | 15 | 10 |
| 4860 20 1045 | 0.6x4.5 | 100 | 14 | 10 |
| 4860 20 1055 | 0.8x5.5 | 100 | 17 | 10 |
| 4860 20 1065 | 1.2x6.5 | 100 | 18 | 10 |
| 4860 20 1545 | 0.6x4.5 | 150 | 21 | 10 |
| 4860 20 1555 | 0.8x5.5 | 150 | 26 | 10 |
| 4860 20 1565 | 1.2x6.5 | 150 | 28 | 10 |

Yıldız Bits Uçlar

Bits Phillips

25mm-50mm-75mm-100mm-150mm



Krom vanadyum
Chrom vanadium

| KOD CODE | ⊕ | L mm | g | TL/Ad. |
|--------------|-----|------|----|--------|
| 4820 21 0001 | Ph1 | 25 | 5 | 10 |
| 4820 21 0002 | Ph2 | 25 | 5 | 10 |
| 4820 21 0003 | Ph3 | 25 | 5 | 10 |
| 4820 21 0011 | Ph1 | 50 | 10 | 10 |
| 4820 21 0012 | Ph2 | 50 | 10 | 10 |
| 4820 21 0013 | Ph3 | 50 | 10 | 10 |
| 4870 21 0701 | Ph1 | 75 | 17 | 10 |
| 4870 21 0702 | Ph2 | 75 | 18 | 10 |
| 4870 21 0703 | Ph3 | 75 | 18 | 10 |
| 4870 21 1001 | Ph1 | 100 | 20 | 10 |
| 4870 21 1002 | Ph2 | 100 | 24 | 10 |
| 4870 21 1003 | Ph3 | 100 | 24 | 10 |
| 4870 21 1501 | Ph1 | 150 | 23 | 10 |
| 4870 21 1502 | Ph2 | 150 | 33 | 10 |
| 4870 21 1503 | Ph3 | 150 | 33 | 10 |

Düz Bits Takımı (25 mm)

Flat Bit Set (25 mm)



| KOD CODE | ⊖ | g | TL/Ad. |
|--------------|---------|----|--------|
| 4810 00 0645 | 0.6x4.5 | 45 | 10 |
| 4810 00 0855 | 0.8x5.5 | 50 | 10 |
| 4810 00 1265 | 1.2x6.5 | 55 | 10 |

Yıldız Bits Takımı (25 mm)

Phillips Bit Set (25 mm)



| KOD CODE | ⊕ | g | TL/Ad. |
|--------------|-----|----|--------|
| 4820 00 0001 | Ph1 | 50 | 10 |
| 4820 00 0002 | Ph2 | 50 | 10 |
| 4820 00 0003 | Ph3 | 55 | 10 |

4825-4880

Pozidriv Bits Uçlar

Bits Pozidriv

25mm-50mm-75mm-100mm-150mm



Krom vanadyum
Chrom vanadium

| KOD CODE | + | L mm | g | TL/Ad. |
|--------------|-----|------|----|--------|
| 4825 21 0001 | Pz1 | 25 | 5 | 10 |
| 4825 21 0002 | Pz2 | 25 | 5 | 10 |
| 4825 21 0003 | Pz3 | 25 | 5 | 10 |
| 4825 21 0011 | Pz1 | 50 | 10 | 10 |
| 4825 21 0012 | Pz2 | 50 | 10 | 10 |
| 4825 21 0013 | Pz3 | 50 | 10 | 10 |
| 4880 21 0701 | Pz1 | 75 | 17 | 10 |
| 4880 21 0702 | Pz2 | 75 | 18 | 10 |
| 4880 21 0703 | Pz3 | 75 | 18 | 10 |
| 4880 21 1001 | Pz1 | 100 | 20 | 10 |
| 4880 21 1002 | Pz2 | 100 | 24 | 10 |
| 4880 21 1003 | Pz3 | 100 | 24 | 10 |
| 4880 21 1501 | Pz1 | 150 | 23 | 10 |
| 4880 21 1502 | Pz2 | 150 | 33 | 10 |
| 4880 21 1503 | Pz3 | 150 | 33 | 10 |

4825

Pozidriv Bits Takımı (25 mm)

Pozidriv Bit Set (25 mm)



| KOD CODE | + | g | TL/Ad. |
|--------------|-----|----|--------|
| 4825 00 0001 | Pz1 | 50 | 10 |
| 4825 00 0002 | Pz2 | 55 | 10 |
| 4825 00 0003 | Pz3 | 55 | 10 |

4830-4885

Torx® Bits Uçlar

Bits Torx®

25mm-50mm-75mm-100mm-150mm



Krom vanadyum
Chrom vanadium

| KOD CODE | ☆ | L mm | g | TL/Ad. |
|--------------|-----|------|----|--------|
| 4830 21 0025 | T25 | 25 | 5 | 10 |
| 4830 21 0027 | T27 | 25 | 5 | 10 |
| 4830 21 0030 | T30 | 25 | 5 | 10 |
| 4830 21 0040 | T40 | 25 | 5 | 10 |
| 4830 21 0125 | T25 | 50 | 10 | 10 |
| 4830 21 0127 | T27 | 50 | 10 | 10 |
| 4830 21 0130 | T30 | 50 | 10 | 10 |
| 4830 21 0140 | T40 | 50 | 10 | 10 |
| 4885 21 0725 | T25 | 75 | 12 | 10 |
| 4885 21 0727 | T27 | 75 | 15 | 10 |
| 4885 21 0730 | T30 | 75 | 15 | 10 |
| 4885 21 0740 | T40 | 75 | 17 | 10 |
| 4885 21 1025 | T25 | 100 | 15 | 10 |
| 4885 21 1027 | T27 | 100 | 20 | 10 |
| 4885 21 1030 | T30 | 100 | 20 | 10 |
| 4885 21 1040 | T40 | 100 | 23 | 10 |
| 4885 21 1525 | T25 | 150 | 20 | 10 |
| 4885 21 1527 | T27 | 150 | 25 | 10 |
| 4885 21 1530 | T30 | 150 | 25 | 10 |
| 4885 21 1540 | T40 | 150 | 33 | 10 |

4830

Torx® Bits Takımı (25 mm)

Torx® Bit Set (25 mm)



| KOD CODE | ☆ | g | TL/Ad. |
|--------------|-----|----|--------|
| 4830 00 0025 | T25 | 50 | 10 |
| 4830 00 0027 | T27 | 50 | 10 |
| 4830 00 0030 | T30 | 55 | 10 |
| 4830 00 0040 | T40 | 60 | 10 |

(☆) İşaretili olan ürünler stoklarla sınırlıdır.
Limited with stocks.

4784

1/4" Avcu İçi Bits Tutucu
Palm Ratchet Bit Holder



**YENİ
NEW**

| KOD CODE | Ø | L mm | g | TL/Ad. |
|--------------|----|------|-----|--------|
| 4784 19 6346 | 46 | 26,5 | 100 | 5 |

4850

75mm Uzun Bits Uç Takımı (13 Parça)
Bit Set, Long Type 75 mm (13 Pcs)



75mm

| KOD CODE | İÇERİK CONTENTS | g | TL/Ad. |
|--------------|--|-----|--------|
| 4850 00 0713 | Düz Uçlar Flat Bits 0.6x4.5 - 0.8x 5.5 1.2x6.5 | 204 | 13 |
| | Yıldız Uçlar Phillips Bits Ph1 - Ph2 - Ph3 | | |
| | Pozidriv Uçlar Pozidriv Bits Pz1 - Pz2 - Pz3 | | |
| | Torx® Uçlar Torx® Bits T25 - T27 T30 - T40 | | |

4850

100mm Uzun Bits Uç Takımı (13 Parça)
Bit Set, Long Type 100 mm (13 Pcs)



100mm

| KOD CODE | İÇERİK CONTENTS | g | TL/Ad. |
|--------------|--|-----|--------|
| 4850 00 1013 | Düz Uçlar Flat Bits 0.6x4.5 - 0.8x 5.5 1.2x6.5 | 263 | 13 |
| | Yıldız Uçlar Phillips Bits Ph1 - Ph2 - Ph3 | | |
| | Pozidriv Uçlar Pozidriv Bits Pz1 - Pz2 - Pz3 | | |
| | Torx® Uçlar Torx® Bits T25 - T27 -T30 - T40 | | |

4850

150mm Uzun Bits Uç Takımı (13 Parça)
Bit Set, Long Type 150 mm (13 Pcs)



150mm

| KOD CODE | İÇERİK CONTENTS | g | TL/Ad. |
|--------------|--|-----|--------|
| 4850 00 1513 | Düz Uçlar Flat Bits 0.6x4.5 - 0.8x 5.5 1.2x6.5 | 356 | 13 |
| | Yıldız Uçlar Phillips Bits Ph1 - Ph2 - Ph3 | | |
| | Pozidriv Uçlar Pozidriv Bits Pz1 - Pz2 - Pz3 | | |
| | Torx® Uçlar Torx® Bits T25 - T27 - T30 - T40 | | |

(★) İşaretili olan ürünler stoklarla sınırlıdır.
Limited with stocks.

4900

Allen Anahtar Altı Köşe (mm) Hex Key Wrench (mm)

TS ISO 2936
DIN ISO 2936

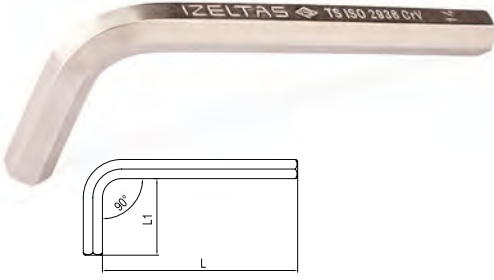

Krom Vanadyum, Nikel Kaplı
Chrom Vanadium, Nickel Plated

| KOD CODE | mm | L mm | L1 mm | g | TL/Ad. |
|--------------|-----|------|-------|------|--------|
| 4900 22 0015 | 1.5 | 45 | 14 | 1.5 | 10 |
| 4900 22 0020 | 2 | 50 | 16 | 2 | 10 |
| 4900 22 0025 | 2.5 | 56 | 18 | 4 | 10 |
| 4900 22 0030 | 3 | 63 | 20 | 6 | 10 |
| 4900 22 0035 | 3.5 | 66 | 22 | 8 | 10 |
| 4900 22 0040 | 4 | 70 | 25 | 10 | 10 |
| 4900 22 0050 | 5 | 80 | 28 | 20 | 10 |
| 4900 22 0060 | 6 | 90 | 32 | 30 | 10 |
| 4900 22 0070 | 7 | 95 | 34 | 40 | 10 |
| 4900 22 0080 | 8 | 100 | 36 | 55 | 10 |
| 4900 22 0090 | 9 | 105 | 38 | 75 | 10 |
| 4900 22 0100 | 10 | 112 | 40 | 100 | 10 |
| 4900 22 0120 | 12 | 125 | 45 | 160 | 10 |
| 4900 22 0140 | 14 | 140 | 56 | 250 | 5 |
| 4900 22 0160 | 16 | 152 | 60 | 375 | 5 |
| 4900 22 0170 | 17 | 160 | 63 | 425 | 5 |
| 4900 22 0190 | 19 | 180 | 70 | 610 | 5 |
| 4900 22 0220 | 22 | 200 | 80 | 940 | 5 |
| 4900 22 0240 | 24 | 224 | 90 | 1250 | 5 |

4900

Allen Anahtar Takım Altı Köşe (mm) Hex Key Wrench Set (mm)



| KOD CODE | İÇERİK CONTENTS | g | TL/Ad. |
|--------------|--|-----|--------|
| 4900 00 3110 | 2 - 2.5 - 3 - 4 - 5 - 6 7 - 8 - 9 - 10 | 400 | 10 |
| 4900 00 3112 | 2 - 2.5 - 3 - 3.5 - 4 - 5 6 - 7 - 8 - 9 - 10 - 12 | 565 | 12 |

4901

Allen Anahtar Altı Köşe (SAE) Hex Key Wrench (SAE)

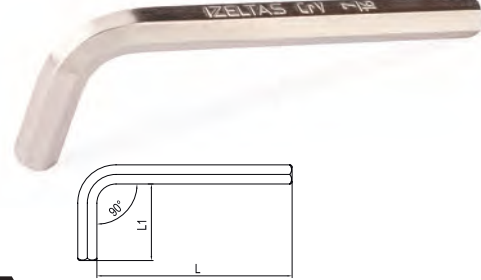

Krom Vanadyum, Nikel Kaplı
Chrom Vanadium, Nickel Plated

| KOD CODE | inch | L mm | L1 mm | g | TL/Ad. |
|--------------|-------|------|-------|-----|--------|
| 4901 22 1984 | 5/64" | 50 | 16 | 2 | 10 |
| 4901 22 2381 | 3/32" | 54 | 18 | 4 | 10 |
| 4901 22 3125 | 1/8" | 58 | 20 | 5 | 10 |
| 4901 22 3968 | 5/32" | 62 | 22 | 10 | 10 |
| 4901 22 4762 | 3/16" | 68 | 24 | 15 | 10 |
| 4901 22 5556 | 7/32" | 74 | 26 | 25 | 10 |
| 4901 22 6350 | 1/4" | 82 | 28 | 35 | 10 |
| 4901 22 7937 | 5/16" | 94 | 32 | 55 | 10 |
| 4901 22 9825 | 3/8" | 106 | 38 | 90 | 10 |
| 4901 22 1111 | 7/16" | 118 | 42 | 130 | 10 |
| 4901 22 1270 | 1/2" | 132 | 46 | 190 | 10 |
| 4901 22 1428 | 9/16" | 144 | 52 | 265 | 10 |
| 4901 22 1587 | 5/8" | 156 | 58 | 365 | 10 |
| 4901 22 1905 | 3/4" | 176 | 66 | 600 | 5 |

4901

Allen Anahtar Takım Altı Köşe (SAE) Hex Key Wrench Set (SAE)



| KOD CODE | İÇERİK CONTENTS | g | TL/Ad. |
|--------------|---|-----|--------|
| 4901 00 3110 | 5/64" - 3/32" - 1/8" - 5/32" 3/16" - 7/32" - 1/4" - 5/16" 3/8" - 7/16" | 405 | 10 |
| 4901 00 3112 | 5/64" - 3/32" - 1/8" - 5/32" 3/16" - 7/32" - 1/4" - 5/16" 3/8" - 7/16" - 1/2" - 9/16" | 855 | 12 |

Allen Anahtar Altı Köşe Uzun Boy (mm)
Hex Key Wrench Long Pattern (mm)

TS ISO 2936
DIN ISO 2936

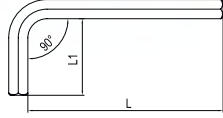

Krom Vanadyum, Nikel Kaplı
Chrom Vanadium, Nickel Plated

| KOD CODE | mm | L mm | L1 mm | g | TL/Ad. |
|--------------|-----|-------|-------|------|--------|
| 4903 22 0020 | 2 | 100 | 16 | 3 | 10 |
| 4903 22 0025 | 2.5 | 112 | 18 | 5 | 10 |
| 4903 22 0030 | 3 | 126 | 20 | 10 | 10 |
| 4903 22 0035 | 3.5 | 136.5 | 22 | 15 | 10 |
| 4903 22 0040 | 4 | 140 | 25 | 20 | 10 |
| 4903 22 0050 | 5 | 160 | 28 | 30 | 10 |
| 4903 22 0060 | 6 | 180 | 32 | 50 | 10 |
| 4903 22 0070 | 7 | 190 | 34 | 80 | 10 |
| 4903 22 0080 | 8 | 200 | 36 | 100 | 10 |
| 4903 22 0090 | 9 | 210 | 38 | 145 | 10 |
| 4903 22 0100 | 10 | 224 | 40 | 180 | 10 |
| 4903 22 0120 | 12 | 250 | 45 | 285 | 10 |
| 4903 22 0140 | 14 | 280 | 56 | 460 | 5 |
| 4903 22 0160 | 16 | 290 | 60 | 625 | 5 |
| 4903 22 0170 | 17 | 320 | 63 | 750 | 5 |
| 4903 22 0190 | 19 | 360 | 70 | 1100 | 5 |

Allen Anahtar Takım Altı Köşe Uzun Boy (mm)
Hex Key Wrench Set Long Pattern (mm)



| KOD CODE | İÇERİK CONTENTS | g | TL/Ad. |
|--------------|--|-----|--------|
| 4903 00 3110 | 2 - 2.5 - 3 - 4 - 5 - 6 7 - 8 - 9 - 10 | 660 | 10 |
| 4903 00 3112 | 2 - 2.5 - 3 - 3.5 - 4 - 5 6 - 7 - 8 - 9 - 10 - 12 | 940 | 12 |

Yuvarlak Başlı Allen Anahtar (mm)
Hex Key Wrench Ballpoint (mm)

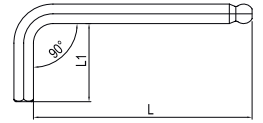

Krom Vanadyum, Nikel Kaplı
Chrom Vanadium, Nickel Plated

| KOD CODE | mm | L mm | L1 mm | g | TL/Ad. |
|--------------|-----|------|-------|-----|--------|
| 4905 22 0020 | 2 | 50 | 16 | 3 | 10 |
| 4905 22 0025 | 2.5 | 56 | 18 | 4 | 10 |
| 4905 22 0030 | 3 | 63 | 20 | 5 | 10 |
| 4905 22 0040 | 4 | 70 | 25 | 10 | 10 |
| 4905 22 0050 | 5 | 80 | 28 | 20 | 10 |
| 4905 22 0060 | 6 | 90 | 32 | 30 | 10 |
| 4905 22 0080 | 8 | 100 | 36 | 55 | 10 |
| 4905 22 0100 | 10 | 112 | 40 | 100 | 10 |

Yuvarlak Başlı Allen Anahtar Takımı (8 Parça, mm)
Hex Key Wrench Ballpoint Set (8 Pcs, mm)



| KOD CODE | İÇERİK CONTENTS | g | TL/Ad. |
|--------------|-----------------------------------|-----|--------|
| 4905 00 7108 | 2 - 2.5 - 3 - 4 5 - 6 - 8 - 10 | 275 | 8 |

(★) İşaretili olan ürünler stoklarla sınırlıdır.
Limited with stocks.

4906

Yuvarlak Başlı Allen Anahtar Uzun Boy (mm)
Hex Key Wrench Ballpoint Long Pattern (mm)

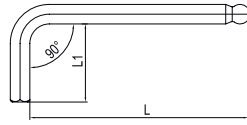

Krom Vanadyum, Nikel Kaplı
Chrom Vanadium, Nickel Plated

| KOD CODE | mm | L mm | L1 mm | g | TL/Ad. |
|--------------|-----|------|-------|-----|--------|
| 4906 22 0015 | 1.5 | 79 | 12 | 1.5 | 10 |
| 4906 22 0020 | 2 | 84 | 16 | 3 | 10 |
| 4906 22 0025 | 2.5 | 89 | 16 | 5 | 10 |
| 4906 22 0030 | 3 | 99 | 18 | 7 | 10 |
| 4906 22 0040 | 4 | 109 | 23 | 13 | 10 |
| 4906 22 0050 | 5 | 125 | 26 | 25 | 10 |
| 4906 22 0060 | 6 | 150 | 28 | 42 | 10 |
| 4906 22 0080 | 8 | 167 | 33 | 85 | 10 |
| 4906 22 0100 | 10 | 190 | 37 | 150 | 10 |

4906

Yuvarlak Başlı Allen Anahtar Takım Altı Köşe Uzun Boy (9 parça, mm)
Hex Key Wrench Ballpoint Long Pattern Set (9 Pcs, mm)



| KOD CODE | İÇERİK CONTENTS | g | TL/Ad. |
|--------------|---|-----|--------|
| 4906 00 3109 | 1.5 - 2 - 2.5 - 3 - 4 - 5 - 6 8 - 10 | 355 | 9 |

4910

Torx® Allen Anahtar
Torx® Key Wrench

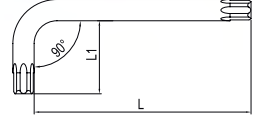

Krom Vanadyum, Nikel Kaplı
Chrom Vanadium, Nickel Plated

| KOD CODE | ☆ | L mm | L1 mm | g | TL/Ad. |
|--------------|-----|------|-------|-----|--------|
| 4910 22 0006 | T6 | 42 | 16 | 2 | 10 |
| 4910 22 0007 | T7 | 48 | 16 | 2 | 10 |
| 4910 22 0008 | T8 | 48 | 16 | 3 | 10 |
| 4910 22 0009 | T9 | 48 | 16 | 3 | 10 |
| 4910 22 0010 | T10 | 51 | 17 | 4 | 10 |
| 4910 22 0015 | T15 | 54 | 18 | 5 | 10 |
| 4910 22 0020 | T20 | 57 | 19 | 5 | 10 |
| 4910 22 0025 | T25 | 60 | 20 | 10 | 10 |
| 4910 22 0027 | T27 | 64 | 21 | 15 | 10 |
| 4910 22 0030 | T30 | 70 | 24 | 20 | 10 |
| 4910 22 0040 | T40 | 76 | 26 | 30 | 10 |
| 4910 22 0045 | T45 | 83 | 29 | 40 | 10 |
| 4910 22 0050 | T50 | 95 | 32 | 60 | 10 |
| 4910 22 0055 | T55 | 108 | 35 | 125 | 10 |
| 4910 22 0060 | T60 | 120 | 38 | 185 | 10 |

4910

Torx® Allen Anahtar Takımı (8 Parça)
Torx® Key Wrench Set (8 Pcs)

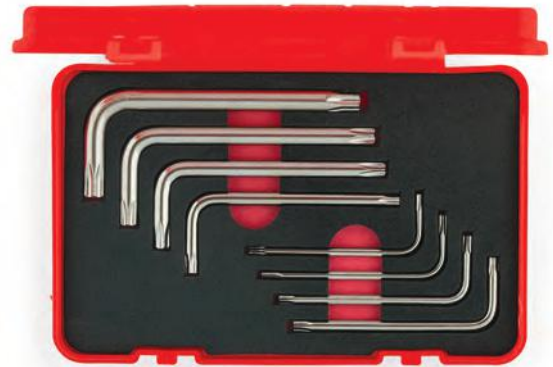

| KOD CODE | İÇERİK CONTENTS | g | TL/Ad. |
|--------------|--|-----|--------|
| 4910 00 7108 | T9 - T10 - T15 T20 - T25 - T27 T30 - T40 | 155 | 8 |

(☆) İşaretili olan ürünler stoklarla sınırlıdır.
Limited with stocks.

4912

Kaset Allen Anahtar Takımı (7 Parça, mm)
Hex Key Wrench Folding Set (7 Pcs, mm)



Krom vanadyum
Chrom vanadium

| KOD CODE | İÇERİK CONTENTS | g | TL/Ad. |
|--------------|------------------------------|-----|--------|
| 4912 00 3107 | 2.5 - 3 - 4 - 5 - 6 - 8 - 10 | 355 | 1 |

4912

Kaset Allen Anahtar Takımı (7 Parça, mm)
Hex Key Wrench Folding Set (7 Pcs, mm)



Krom vanadyum
Chrom vanadium

| KOD CODE | İÇERİK CONTENTS | g | TL/Ad. |
|--------------|--------------------------------|-----|--------|
| 4912 00 0007 | 1.5 - 2 - 2.5 3 - 4 - 5 - 6 | 130 | 1 |

4909

T Tipi Torx® Allen Anahtar
T Handle Torx Key Wrench

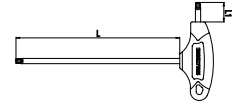

Krom vanadyum, Nikel kaplı
Chrom vanadium, Nickel plated

| KOD CODE | ☆ | L1 mm | L2 mm | g | TL/Ad. |
|--------------|-----|-------|-------|-----|--------|
| 4909 22 0009 | T9 | 125 | 15 | 22 | 5 |
| 4909 22 0010 | T10 | 125 | 15 | 22 | 5 |
| 4909 22 0015 | T15 | 125 | 15 | 26 | 5 |
| 4909 22 0020 | T20 | 125 | 15 | 44 | 5 |
| 4909 22 0025 | T25 | 150 | 20 | 49 | 5 |
| 4909 22 0027 | T27 | 150 | 20 | 62 | 5 |
| 4909 22 0030 | T30 | 150 | 20 | 82 | 5 |
| 4909 22 0040 | T40 | 175 | 25 | 100 | 5 |

4909

T Tipi Torx® Allen Anahtar Takımı (8 Parça)
T Handle Torx® Key Wrench Set (8 Pcs)



| KOD CODE | İÇERİK CONTENTS | g | TL/Ad. |
|--------------|---|-----|--------|
| 4909 00 8108 | T9 - T10 - T15 - T20 T25 - T27 - T30 - T40 | 407 | 8 |

(★) İşaretili olan ürünler stoklarla sınırlıdır.
Limited with stocks.

4920

T Tipi Allen Anahtar (mm)
Hex Key Wrench T - Handle (mm)

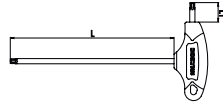

Krom Vanadyum
Chrom Vanadium

| KOD CODE | mm | L mm | L1 mm | g | TL/Ad. |
|--------------|-----|------|-------|-----|--------|
| 4920 22 0025 | 2.5 | 110 | 14 | 20 | 5 |
| 4920 22 0030 | 3 | 125 | 17 | 23 | 5 |
| 4920 22 0040 | 4 | 140 | 20 | 45 | 5 |
| 4920 22 0050 | 5 | 155 | 23 | 58 | 5 |
| 4920 22 0060 | 6 | 170 | 26 | 100 | 5 |
| 4920 22 0070 | 7 | 185 | 30 | 125 | 5 |
| 4920 22 0080 | 8 | 200 | 34 | 150 | 5 |
| 4920 22 0100 | 10 | 220 | 40 | 240 | 5 |

4921

T Tipi Yuvarlak Başlı Allen Anahtar (mm)
Hex Key Wrench T - Handle Ballpoint (mm)

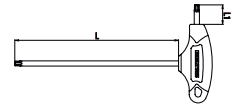

Krom Vanadyum
Chrom Vanadium

| KOD CODE | mm | L mm | L1 mm | g | TL/Ad. |
|--------------|-----|------|-------|-----|--------|
| 4921 22 0025 | 2.5 | 110 | 14 | 20 | 5 |
| 4921 22 0030 | 3 | 125 | 17 | 23 | 5 |
| 4921 22 0040 | 4 | 140 | 20 | 45 | 5 |
| 4921 22 0050 | 5 | 155 | 23 | 58 | 5 |
| 4921 22 0060 | 6 | 170 | 26 | 100 | 5 |
| 4921 22 0070 | 7 | 185 | 30 | 125 | 5 |
| 4921 22 0080 | 8 | 200 | 34 | 150 | 5 |
| 4921 22 0100 | 10 | 220 | 40 | 235 | 5 |

4920

T Tipi Allen Anahtar Takımı (8 Parça, mm)
Hex Key Wrench T - Handle Set (8 Pcs, mm)



| KOD CODE | İÇERİK CONTENTS | g | TL/Ad. |
|--------------|-----------------------------------|-----|--------|
| 4920 00 8108 | 2.5 - 3 - 4 - 5 6 - 7 - 8 - 10 | 760 | 8 |

4921

T Tipi Yuvarlak Başlı Allen Anahtar Takımı (8 Parça, mm)
Hex Key Wrench T - Handle Ballpoint Set (8 Pcs, mm)



| KOD CODE | İÇERİK CONTENTS | g | TL/Ad. |
|--------------|-----------------------------------|-----|--------|
| 4921 00 8108 | 2.5 - 3 - 4 5 - 6 - 7 - 8 - 10 | 755 | 8 |

(★) İşaretili olan ürünler stoklarla sınırlıdır.
Limited with stocks.

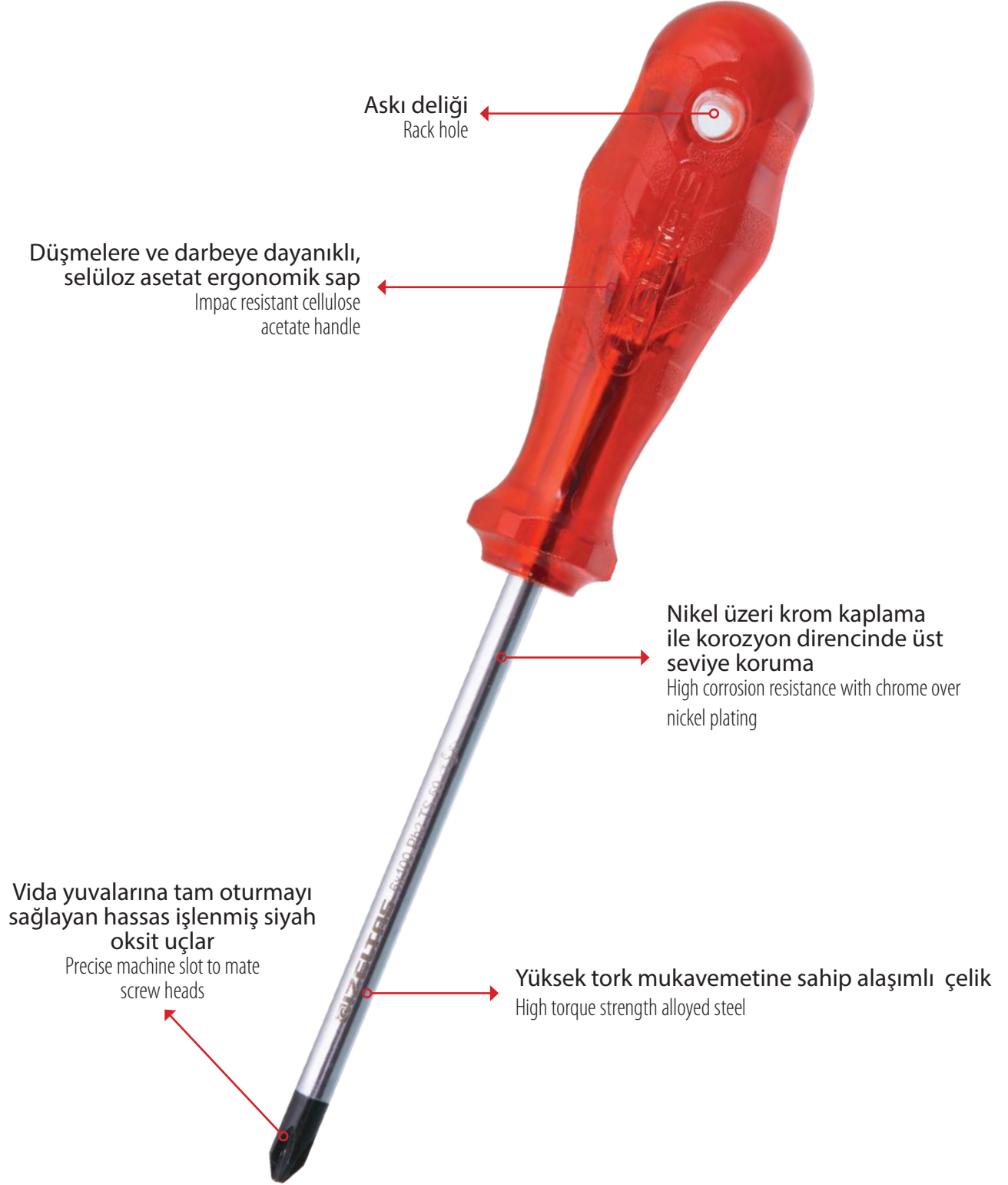

İZELTAS YOUTUBE

(★) İşaretili olan ürünler stoklarla sınırlıdır.
Limited with stocks.

IZELTAS®

KESKİLER VE ÇEKİÇLER

CHISELS AND HAMMERS

Keskiler
Chisels

Zimbalar
Punches

Çekiçler
Hammers

Keserler
Adzes





Darbeyi eşit olarak dağıtmaya yarayan yuvarlak çelik kama
Steel wedge to equally distribute impact

İndüksiyonda sertleştirilmiş darbe yüzeyleri
Induction hardened impact surfaces

Yüksek karbonlu sıcak dövme çeliği ile arttırılmış dayanım
High carbon, hot forged steel

Sapın çıkmasını engelleyen epoksi yapıştırıcı
Epoxy glue to prevent handle separation

İndüksiyonda sertleştirilmiş darbe yüzeyleri
Induction hardened impact surfaces

Sap-gövde birleşiminden kırılmayı önleyen çelik yüzük
Steel bushing to prevent breakage at the head and handle connection area

Dışbudak ağacından üretilmiş, el ergonomisine uygun özel tasarımlı, vernikli ahşap sap
Ergonomic special design handle produced from strong ash tree hardwood



İZELTAŞ USTA İŞİ
SOHBETLER

5010

Iskarpela (Düz) Wood Chisel

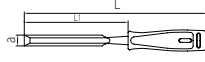

Özel alaşımli çelik, Uç indüksiyonda sertleştirilmiş, PP Saplı
Special steel, Induction hardened tips, PP Handle

| KOD CODE | a mm | L mm | L1 mm | g | TL/Ad. |
|--------------|------|------|-------|-----|--------|
| 5010 23 0006 | 6 | 245 | 120 | 115 | 5 |
| 5010 23 0008 | 8 | 245 | 122 | 125 | 5 |
| 5010 23 0010 | 10 | 245 | 124 | 135 | 5 |
| 5010 23 0012 | 12 | 245 | 126 | 135 | 5 |
| 5010 23 0014 | 14 | 245 | 128 | 145 | 5 |
| 5010 23 0016 | 16 | 255 | 130 | 150 | 5 |
| 5010 23 0018 | 18 | 255 | 132 | 160 | 5 |
| 5010 23 0020 | 20 | 255 | 134 | 170 | 5 |
| 5010 23 0022 | 22 | 255 | 136 | 190 | 5 |
| 5010 23 0024 | 24 | 255 | 138 | 195 | 5 |
| 5010 23 0026 | 26 | 255 | 140 | 200 | 5 |
| 5010 23 0030 | 30 | 260 | 146 | 205 | 5 |

5010

Iskarpela Takım (6 parça) Wood Chisel Set (6 Pcs)



| KOD CODE | İÇERİK CONTENTS | g | TL/Ad. |
|--------------|------------------------------|-----|--------|
| 5010 00 8106 | 10 - 12 - 14 16 - 18 - 20 | 985 | 6 |

5500

Düz Keski Flat Cold Chisel

TS 492
DIN 6453



Özel alaşımli çelik, Krom kaplı
Special steel, Chrom plated

| KOD CODE | L mm | a mm | g | TL/Ad. |
|--------------|------|------|-----|--------|
| 5500 23 0100 | 100 | 17 | 75 | 5 |
| 5500 23 0125 | 125 | 19 | 110 | 5 |
| 5500 23 0150 | 150 | 21 | 180 | 5 |
| 5500 23 0175 | 175 | 24 | 245 | 5 |
| 5500 23 0200 | 200 | 27 | 340 | 5 |
| 5500 23 0250 | 250 | 30 | 525 | 5 |
| 5500 23 0300 | 300 | 30 | 635 | 5 |

5500

Düz Keski (Kalkan İzoleli) Flat Cold Chisel (With Safety Handle)

TS 492
DIN 6453

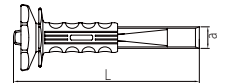

Özel alaşımli çelik, Krom kaplı
Special steel, Chrom plated

| KOD CODE | L mm | a mm | g | TL/Ad. |
|--------------|------|------|-----|--------|
| 5500 23 1250 | 250 | 30 | 700 | 1 |
| 5500 23 1300 | 300 | 30 | 790 | 1 |

(★) İşaretili olan ürünler stoklarla sınırlıdır.
Limited with stocks.

5510

Tesviyeci Düz Keski
Flat Cold Chisel Octagonal

TS 492
DIN 6453

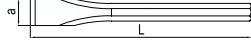

Krom vanadyum, Krom kaplı
Chrom vanadium, Chrom plated

| KOD CODE | L mm | a mm | g | TL/Ad. |
|--------------|------|------|-----|--------|
| 5510 23 0125 | 125 | 10 | 75 | 10 |
| 5510 23 0150 | 150 | 14 | 125 | 10 |

5520

Tırnak Keski
Cross Cut Chisel

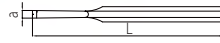

Krom vanadyum, Krom kaplı
Chrom vanadium, Chrom plated

| KOD CODE | L mm | a mm | g | TL/Ad. |
|--------------|------|------|-----|--------|
| 5520 23 0125 | 130 | 5 | 70 | 10 |
| 5520 23 0150 | 150 | 6 | 110 | 10 |

5540

Nokta Zimba
Center Punch

DIN 7250

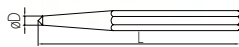

Krom vanadyum, Elektrostatik boyanmış
Chrom vanadium, Electrostatically painted

| KOD CODE | L mm | L inch | σD mm | g | TL/Ad. |
|---------------|------|--------|-------|-----|--------|
| 5540 24 4120 | 120 | 4 3/4" | 4 | 65 | 10 |
| 5540 24 5120 | 120 | 4 3/4" | 5 | 95 | 10 |
| 5540 24 5150 | 150 | 6" | 5 | 115 | 10 |
| ★5540 24 0412 | 120 | 4 3/4" | 4 | 65 | 10 |

★ Krom Kaplı / Chrom Plated

5545

Konik Pim Zimba
Drift Punch

DIN 6458

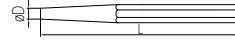

Krom vanadyum, Elektrostatik boyanmış
Chrom vanadium, Electrostatically painted

| KOD CODE | L mm | L inch | σD mm | g | TL/Ad. |
|---------------|------|--------|-------|-----|--------|
| 5545 24 0002 | 120 | 4 3/4" | 2 | 90 | 10 |
| 5545 24 0003 | 120 | 4 3/4" | 3 | 90 | 10 |
| 5545 24 0004 | 120 | 4 3/4" | 4 | 90 | 10 |
| 5545 24 0005 | 120 | 4 3/4" | 5 | 95 | 10 |
| 5545 24 0006 | 120 | 4 3/4" | 6 | 95 | 10 |
| 5545 24 0007 | 120 | 4 3/4" | 7 | 100 | 10 |
| 5545 24 0008 | 150 | 6" | 8 | 125 | 10 |
| 5545 24 0009 | 150 | 6" | 9 | 130 | 10 |
| 5545 24 0010 | 150 | 6" | 10 | 130 | 10 |
| 5545 24 0012 | 150 | 6" | 12 | 180 | 10 |
| ★5545 24 0103 | 120 | 4 3/4" | 3 | 90 | 10 |

5550

Düz Pim Zimba
Split Pin Punch

DIN 6450

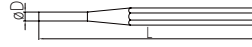

Krom vanadyum, Elektrostatik boyanmış
Chrom vanadium, Electrostatically painted

| KOD CODE | L mm | L inch | σD mm | g | TL/Ad. |
|---------------|------|--------|-------|-----|--------|
| 5550 24 0002 | 150 | 6" | 2 | 70 | 5 |
| 5550 24 0003 | 150 | 6" | 3 | 65 | 5 |
| 5550 24 0004 | 150 | 6" | 4 | 65 | 5 |
| 5550 24 0005 | 150 | 6" | 5 | 65 | 5 |
| 5550 24 0006 | 150 | 6" | 6 | 70 | 5 |
| 5550 24 0007 | 150 | 6" | 7 | 100 | 5 |
| 5550 24 0008 | 150 | 6" | 8 | 105 | 5 |
| 5550 24 0009 | 150 | 6" | 9 | 110 | 5 |
| 5550 24 0010 | 150 | 6" | 10 | 120 | 5 |
| ★5550 24 0105 | 150 | 6" | 5 | 65 | 5 |

5550

Düz Pim Zimba Takımı (6 Parça)
Split Pin Punch (6 Pcs)



| KOD CODE | İÇERİK CONTENTS | g | TL/Ad. |
|--------------|-----------------------|-----|--------|
| 5550 00 1006 | 3 - 4 - 5 - 6 - 7 - 8 | 865 | 6 |

(★) İşaretili olan ürünler stoklarla sınırlıdır.
Limited with stocks.

5600

Keski Zimba Seti (6 Parça) Chisel And Punch Set (6 Pcs)



| KOD CODE | İÇERİK CONTENTS | g | TL/Ad. |
|--------------|--|-----|--------|
| 5600 00 6106 | 125 Tevsiyeci Düz Keski 125 Flat Cold Chisel Octagonal | 865 | 6 |
| | 150 Tevsiyeci Düz Keski 150 Flat Cold Chisel Octagonal | | |
| | 130 Tırnak Keski 130 Cross Cut Chisel | | |
| | 4x120 Nokta Zimba 4x120 Center Punch | | |
| | 5x150 Düz Pim Zimba 5x150 Split PinPunch | | |
| | 3x120 Konik Pim Zimba 3x120 Drift Punch | | |



5700

Kayış Zimba Belt Punch

DIN 7200

TSEK



Krom vanadyum, Elektrostatik boyanmış
Chrom vanadium, Electrostatically painted

| KOD CODE | ØD mm | L mm | g | TL/Ad. |
|--------------|-------|------|-----|--------|
| 5700 24 0003 | 3 | 105 | 35 | 10 |
| 5700 24 0004 | 4 | 105 | 40 | 10 |
| 5700 24 0005 | 5 | 110 | 50 | 10 |
| 5700 24 0006 | 6 | 110 | 60 | 10 |
| 5700 24 0007 | 7 | 115 | 75 | 10 |
| 5700 24 0008 | 8 | 115 | 90 | 10 |
| 5700 24 0009 | 9 | 120 | 100 | 10 |
| 5700 24 0010 | 10 | 120 | 110 | 10 |
| 5700 24 0011 | 11 | 125 | 130 | 5 |
| 5700 24 0012 | 12 | 125 | 165 | 5 |
| 5700 24 0013 | 13 | 130 | 165 | 5 |
| 5700 24 0014 | 14 | 130 | 180 | 5 |
| 5700 24 0015 | 15 | 135 | 245 | 5 |
| 5700 24 0016 | 16 | 135 | 300 | 5 |
| 5700 24 0017 | 17 | 140 | 365 | 5 |
| 5700 24 0018 | 18 | 140 | 380 | 5 |
| 5700 24 0019 | 19 | 145 | 405 | 5 |
| 5700 24 0020 | 20 | 145 | 450 | 5 |

5700

Kayış Zimba Takımı Belt Punch Set

TSEK



| KOD CODE | İÇERİK CONTENTS | g | TL/Ad. |
|--------------|---|------|--------|
| 5700 00 2110 | 3 - 4 - 5 - 6 - 7 8 - 9 - 10 - 11 - 12 | 845 | 10 |
| 5700 00 2112 | 3 - 4 - 5 - 6 - 7 - 8 - 9 10 - 11 - 12 - 13 - 14 | 1180 | 12 |

(★) İşaretili olan ürünler stoklarla sınırlıdır.
Limited with stocks.

5800

Tesviyeci Çekiç
Machinist Hammer

TS 5-1
DIN 1041



İZELTAS YOUTUBE

Yedek parça sayfa 199
Spare parts page 199

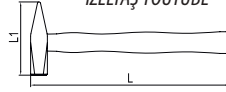

Özel alaşımli çelik, İndüksiyonda sertleştirilmiş, Elektrostatik boyanmış
Special steel, Induction hardened, Electrostatically painted

| KOD CODE | L mm | L1 mm | g | g | TL/Ad. |
|--------------|------|-------|------|------|--------|
| 5800 25 0100 | 260 | 82 | 100 | 160 | 10 |
| 5800 25 0200 | 280 | 95 | 200 | 260 | 10 |
| 5800 25 0300 | 300 | 105 | 300 | 395 | 10 |
| 5800 25 0500 | 320 | 118 | 500 | 600 | 5 |
| 5800 25 1000 | 360 | 135 | 1000 | 1095 | 5 |
| 5800 25 1500 | 380 | 145 | 1500 | 1630 | 5 |
| 5800 25 2000 | 400 | 155 | 2000 | 2100 | 5 |

5810

Emniyet Çekici
Safety Hammer

TS 5-1

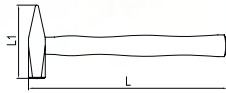

Özel alaşımli çelik, İndüksiyonda sertleştirilmiş, Elektrostatik boyanmış
Special steel, Induction hardened, Electrostatically painted

| KOD CODE | L mm | L1 mm | g | g | TL/Ad. |
|--------------|------|-------|------|------|--------|
| 5810 25 1000 | 360 | 135 | 1000 | 1095 | 5 |
| 5810 25 1500 | 380 | 145 | 1500 | 1630 | 5 |
| 5810 25 2000 | 400 | 155 | 2000 | 2100 | 5 |

Emniyet çekici

Çekiç kafası ile sapın birleşiminde yuvarlak kama ve yapışkan malzeme kullanılarak sağlamlığı artırılmış ayrıca birleşimi çelik sac malzeme ile desteklenerek güvenli kullanım sağlanmıştır.

Safety Hammer

Connection between the hammer head and the handle is ensured by circular wedge and epoxy glue, while it is also reinforced by sheet metal for safe use.

5850

Plastik Çekiç
Plastic Hammer

TS 5

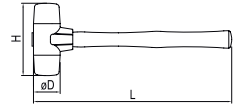

Yedek parça sayfa 199
Spare parts page 199

Darbeye dayanıklı, Kolay değiştirilebilir başlık
Durable and easily changeable heads

| KOD CODE | L mm | øD mm | H mm | g | TL/Ad. |
|--------------|------|-------|------|------|--------|
| 5850 25 0030 | 300 | 30 | 100 | 345 | 5 |
| 5850 25 0040 | 320 | 40 | 110 | 645 | 5 |
| 5850 25 0050 | 350 | 50 | 120 | 1015 | 5 |

5870

Lastik Çekiç
Rubber Hammer

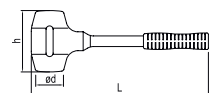

| KOD CODE | L mm | ød mm | h mm | g | g | TL/Ad. |
|--------------|------|-------|------|-----|-----|--------|
| 5870 25 0400 | 300 | 47 | 104 | 400 | 610 | 5 |

(*) İşaretili olan ürünler stoklarla sınırlıdır.
Limited with stocks.

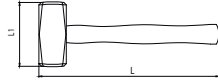
5865
Madırğa
Mallet

Yedek parça sayfa 199
Spare parts page 199
Özel alaşımli çelik
Special steel

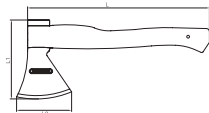
| KOD CODE | L mm | L1 mm | | | | TL/Ad. |
|--------------|------|-------|------|------|---|--------|
| 5865 25 1000 | 260 | 95 | 1000 | 1210 | 5 | |
| 5865 25 1500 | 280 | 110 | 1500 | 1770 | 5 | |

6410
Nacak
Hatchet

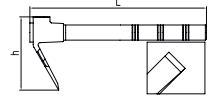
Yedek parça sayfa 199
Spare parts page 199
Özel alaşımli çelik, İndüksiyonda sertleştirilmiş, Elektrostatik boyanmış
Special steel, Induction hardened, Electrostatically painted

| KOD CODE | L mm | L1 mm | L2 mm | | | | TL/Ad. |
|--------------|------|-------|-------|-----|------|---|--------|
| 6410 25 0800 | 380 | 165 | 115 | 800 | 1065 | 1 | |

6400
Keser
Adze

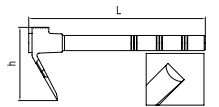
Yedek parça sayfa 199
Spare parts page 199
Özel alaşımli çelik, İndüksiyonda sertleştirilmiş, Elektrostatik boyanmış, PVC ağız koruyucu
Special steel, Induction hardened, Electrostatically painted, PVC cutting edge protector

| KOD CODE | L mm | h mm | | | | TL/Ad. |
|--------------|------|------|-----|-----|---|--------|
| 6400 25 0600 | 400 | 125 | 400 | 550 | 5 | |

6401
Usta Keseri
Master Adze

Yedek parça sayfa 199
Spare parts page 199
Özel alaşımli çelik, İndüksiyonda sertleştirilmiş, Elektrostatik boyanmış, PVC ağız koruyucu
Special steel, Induction hardened, Electrostatically painted, PVC cutting edge protector

| KOD CODE | L mm | h mm | | | | TL/Ad. |
|--------------|------|------|-----|-----|---|--------|
| 6401 25 0600 | 400 | 125 | 400 | 540 | 5 | |

(★) İşaretili olan ürünler stoklarla sınırlıdır.
Limited with stocks.



ZELTAS
DIN 8131 - 5232

INDUCTION
HARDENED
800 GR.

8410



ZELTAS

GENEL EL ALETLERİ

GENERAL HAND TOOLS

Servis Aletleri
Service Equipment

Perçin Tabancası
Riveting Pliers

İşkenceler
Clamps

İnşaat Ekipmanları
Construction Equipment

Metreler
Measuring Tapes

Mengene
Forged Steel Vice

Su Terazisi
Straight Level

Gres Pompası
Grease Gun



KABLO SIYIRICI (KANCA BIÇAKLI) / CABLE STRIPPER (WITH HOOKED BLADE)

Tüm standart kabloları sıyırmak için daha uzun ömür, daha hızlı kesme ve daha az aşınma sağlayan özel titanyum nitrür (TIN) kaplama
Tin plated long lasting/fast cutting blade to strip all standard cables

Özel alışımli çelikten sertleştirilmiş ve kaplanmış kanca bıçak
Plated special alloy hardened steel hook blade

Kapasite 8-28mm çaplı kablolar için uygun
Suitable for 8-28mm diameter cables

Özel kaydırmaz formu dayanıklı polyamid (PA) sap
Non-slip and durable polyamid handle

Çevirerek kolay bıçak yükseklik ayarı
Easy-to-rotate blade height adjuster

03750

Kablo Sıyrıcı (Kanca Bıçaklı)
Cable Stripper (With Hooked Blade)



 Yedek parça sayfa 199
Spare parts page 199

| KOD CODE | ÖLÇÜ SIZE | g | | TL/Ad. |
|--------------|-----------|----|---|--------|
| 03750 50 020 | Ø8-28 | 79 | 5 | |

03753

Mekanik Kablo Sıyrıcı
Mechanical Cable Stripper



| KOD CODE | ÖLÇÜ SIZE | g | | TL/Ad. |
|--------------|-----------|-----|---|--------|
| 03753 50 054 | 0.5/4 | 100 | 5 | |

03752

Kablo Sıyrıcı
Cable Stripper



 Yedek parça sayfa 199
Spare parts page 199



İZELTAS YOUTUBE

| KOD CODE | ÖLÇÜ SIZE | g | | TL/Ad. |
|--------------|-------------------------|----|---|--------|
| 03752 50 625 | Tek 6/300 Çok 1.5/25 | 70 | 5 | |

05881

Krom Şerit Metre
Chrom Steel Case, Measuring tapes



| KOD CODE | ÖLÇÜ SIZE M | g | | TL/Ad. |
|--------------|-------------|-----|---|--------|
| 05881 50 013 | 3 | 160 | 5 | |
| 05881 50 015 | 5 | 220 | 5 | |

03751

Koaksiyel Kablo Sıyrıcı
Coaxial Cable Stripper



İZELTAS YOUTUBE

| KOD CODE | ÖLÇÜ SIZE | g | | TL/Ad. |
|--------------|-------------------|----|---|--------|
| 03751 50 012 | Dış (1) İç (2) | 20 | 5 | |

05881

Plastik Şerit Metre
Plastic Steel Case, Measuring tapes



| KOD CODE | ÖLÇÜ SIZE M | g | | TL/Ad. |
|--------------|-------------|-----|---|--------|
| 05881 50 003 | 3 | 145 | 5 | |
| 05881 50 005 | 5 | 200 | 5 | |

(*) İşaretili olan ürünler stoklarla sınırlıdır.
Limited with stocks.

05886

Arazi Tipi Fiberglas Şerit Metre (Saplı)
Fiberglass Measuring Tape Field Type (With Holder)



| KOD CODE | ÖLÇÜ SIZE M | g | | TL/Ad. |
|--------------|-------------|-----|---|--------|
| 05886 50 020 | 20 | 520 | 1 | |
| 05886 50 030 | 30 | 585 | 1 | |
| 05886 50 050 | 50 | 820 | 1 | |

05880

Su Terazisi
Straight Level



Alüminyum gövde
Aluminum body

| KOD CODE | L mm | g | | TL/Ad. |
|--------------|------|-----|---|--------|
| 05880 50 040 | 400 | 250 | 5 | |
| 05880 50 050 | 500 | 300 | 5 | |
| 05880 50 060 | 600 | 350 | 5 | |
| 05880 50 070 | 700 | 400 | 5 | |
| 05880 50 080 | 800 | 450 | 5 | |
| 05880 50 100 | 1000 | 500 | 5 | |
| 05880 50 120 | 1200 | 550 | 5 | |
| 05880 50 150 | 1500 | 600 | 5 | |
| 05880 50 200 | 2000 | 800 | 5 | |

05887

Kumpas
Vernier



Sürgülü, Stoplu
Sliding and with stop

| KOD CODE | L mm | g | | TL/Ad. |
|--------------|------|-----|---|--------|
| 05887 50 150 | 150 | 155 | 5 | |

05890

Testere Kolu
Hacksaw Frame



Yedek parça sayfa 200
Spare parts page 200

| KOD CODE | L mm | g | | TL/Ad. |
|--------------|------|-----|---|--------|
| 05890 50 830 | 300 | 540 | 5 | |

6735

Dal Budama Testeresi
Pruning Saw



Yedek parça sayfa 200
Spare parts page 200

| KOD CODE | L mm | g | | TL/Ad. |
|--------------|------|-----|---|--------|
| 6735 27 0300 | 300 | 400 | 5 | |

(★) İşaretili olan ürünler stoklarla sınırlıdır.
Limited with stocks.

05901

Sentil (20 Parça, mm)
Feeler Gauges (20 Pcs, mm)



| KOD CODE | ÖLÇÜ SIZE mm | g | TL/Ad. |
|--------------|--------------|----|--------|
| 05901 50 020 | 0.05 - 1 | 90 | 10 |

05902

Sentil (20 Parça, SAE)
Feeler Gauges (20 Pcs, SAE)



| KOD CODE | ÖLÇÜ SIZE inch | g | TL/Ad. |
|--------------|----------------|----|--------|
| 05902 50 020 | 2 - 35/1000" | 65 | 10 |

6195

Perçin Tabancası
Riveting Pliers



| KOD CODE | ÖLÇÜ SIZE | CAPACITY mm | g | TL/Ad. |
|--------------|-----------|-------------------|-----|--------|
| 6195 26 0260 | 260 | 2 - 2.5 - 3 - 3.2 | 625 | 1 |

6220

Spiralli Mıknatıs
Flexible Magnet Holder

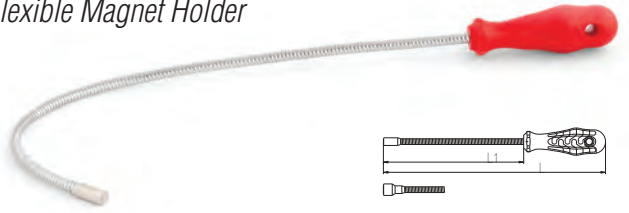

| KOD CODE | KAPASİTE g | L mm | L1 mm | g | TL/Ad. |
|--------------|------------|------|-------|-----|--------|
| 6220 26 0500 | 500 | 465 | 375 | 100 | 10 |
| 6220 26 1000 | 1000 | 465 | 375 | 105 | 10 |

6225

Madeni Yağdanlık (Flexible Uçlu)
Oiler With Flexible Spout



| KOD CODE | ÖLÇÜ SIZE cc | g | TL/Ad. |
|--------------|--------------|-----|--------|
| 6225 26 0200 | 200 | 170 | 5 |
| 6225 26 0300 | 300 | 200 | 5 |
| 6225 26 0500 | 500 | 225 | 5 |

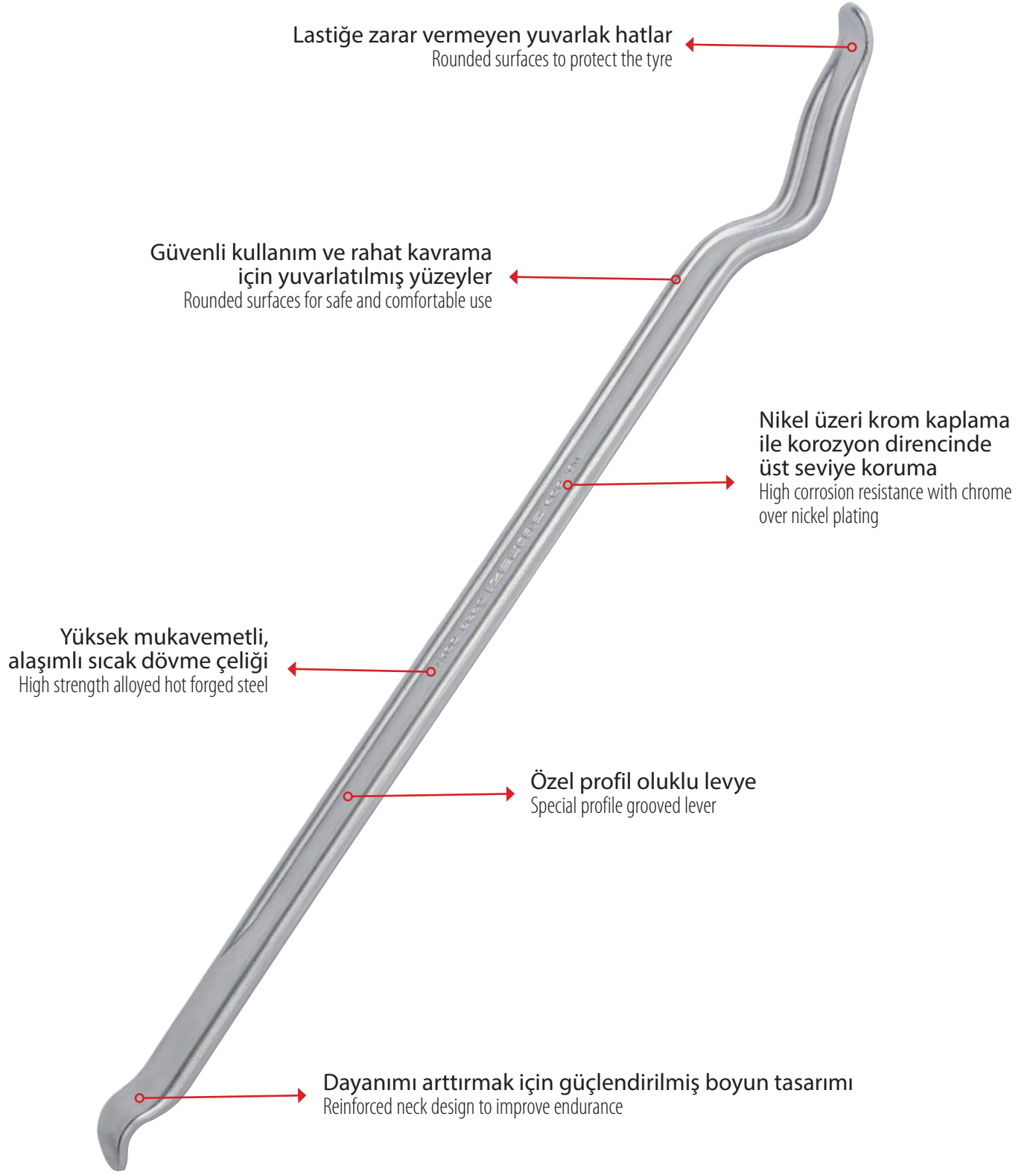

Lastiğe zarar vermeyen yuvarlak hatlar
Rounded surfaces to protect the tyre

Güvenli kullanım ve rahat kavrama
için yuvarlatılmış yüzeyler
Rounded surfaces for safe and comfortable use

Nikel üzeri krom kaplama
ile korozyon direncinde
üst seviye koruma
High corrosion resistance with chrome
over nickel plating

Yüksek mukavemetli,
alaşımli sıcak dövme çeliği
High strength alloyed hot forged steel

Özel profil oluklu levye
Special profile grooved lever

Dayanımı arttırmak için güçlendirilmiş boyun tasarımı
Reinforced neck design to improve endurance

6230

Gres Pompası
Grease Gun

 Yedek parça sayfa 200
Spare parts page 200

| KOD CODE | ÖLÇÜ SIZE cc | g | | TL/Ad. |
|--------------|--------------|------|---|--------|
| 6230 26 0300 | 300 | 1200 | 1 | |
| 6230 26 0500 | 500 | 1320 | 1 | |

6240

Tapa Anahtarı (iki ağız)
Offset Wrench For Carter Case



| KOD CODE | ÖLÇÜ mm | g | | TL/Ad. |
|--------------|---------|-----|----|--------|
| 6240 26 0810 | 8x10 | 250 | 10 | |

6350

Levye Oluklu
Tyre Lever, Straight

TSEK



Krom vanadyum, Krom kaplı
Chrom vanadium, Chrom plated

| KOD CODE | L mm | L inch | g | | TL/Ad. |
|--------------|------|--------|-----|---|--------|
| 6350 26 0300 | 300 | 12" | 265 | 5 | |
| 6350 26 0400 | 400 | 16" | 440 | 5 | |
| 6350 26 0500 | 500 | 20" | 675 | 5 | |
| 6350 26 0600 | 600 | 24" | 900 | 5 | |

6360

Levye Oluklu Kıvrık Uçlu
Tyre Lever, Bent

TSEK



Krom vanadyum, Krom kaplı
Chrom vanadium, Chrom plated

| KOD CODE | L mm | L inch | g | | TL/Ad. |
|--------------|------|--------|-----|---|--------|
| 6360 26 0600 | 600 | 24" | 910 | 5 | |

6370

Yağ Filtresi Sökeceği
Band Type Oil Filter Wrench



| KOD CODE | g mm | g | | TL/Ad. |
|--------------|----------|-----|---|--------|
| 6370 26 0100 | 75 - 100 | 335 | 5 | |



(★) İşaretili olan ürünler stoklarla sınırlıdır.
Limited with stocks.

6375

Çift Yönlü Üç Ayaklı Yağ Filtresi Sökeceği
Left and Right Hand Operation, Triple Leg Oil Filter Wrench

**3/8" - 1/2"**

| KOD CODE | Ø mm | g | TL/Ad. |
|--------------|--------|-----|--------|
| 6375 26 6512 | 75-120 | 605 | 5 |

06374

Zincirli Yağ Filtresi Sökeceği
Chain Wrench



| KOD CODE | Ø mm | g | TL/Ad. |
|--------------|--------|-----|--------|
| 06374 50 140 | 60x140 | 390 | 5 |

6380

Çift Zincirli Yağ Filtresi Sökeceği
Oil Filter Wrench With Double Chain



| KOD CODE | Ø mm | g | TL/Ad. |
|--------------|--------|-----|--------|
| 6380 26 6016 | 60-160 | 380 | 5 |

06373

Kayıslı Yağ Filtresi Sökeceği
Strap Wrench



| KOD CODE | Ø mm | g | TL/Ad. |
|--------------|--------|-----|--------|
| 06373 50 140 | 60x140 | 245 | 5 |

06375

Ayarlı Yağ Filtresi Sökeceği
Adjustable Slot Type Oil Filter Wrench



 Yedek parça sayfa 199
Spare parts page 199

| KOD CODE | Ø mm | g | TL/Ad. |
|--------------|--------|-----|--------|
| 06375 50 100 | 65-110 | 215 | 5 |

06390

Segman Çemberi
Piston Ring Compressor



| KOD CODE | Ø mm | g | | TL/Ad. |
|--------------|------|-----|---|--------|
| 06390 50 125 | 125 | 235 | 5 | |
| 06390 50 175 | 175 | 505 | 5 | |

07415

Sıralı Tel Fırça (Ağaç Saplı)
Hand Brush (Wooden Handle)



| KOD CODE | ÖLÇÜ SIZE | g | | TL/Ad. |
|--------------|---------------|-----|---|--------|
| 07415 50 003 | 3 SIRA 3 RAWS | 125 | 5 | |
| 07415 50 004 | 4 SIRA 4 RAWS | 135 | 5 | |
| 07415 50 005 | 5 SIRA 5 RAWS | 145 | 5 | |
| 07415 50 006 | 6 SIRA 6 RAWS | 170 | 5 | |

07416

Kıvrık Uçlu Fırça (Plastik Saplı)
Hand Brush (PP Handle)



| KOD CODE | L mm | g | | TL/Ad. |
|--------------|------|-----|---|--------|
| 07416 50 001 | 270 | 110 | 5 | |

07410

Makaralı Uzatma Kablosu
(El Tipi)
Extension Cord Reel
(With Handle)



Kablo / Cable ø 3x1.5 mm

| KOD CODE | MODEL | ÖLÇÜ SIZE | g | | TL/Ad. |
|--------------|-----------------------|-----------|------|---|--------|
| 07410 50 010 | el tipi / with handle | 10 | 1400 | 1 | |

07410

Makaralı Uzatma Kablosu
(Ayaklı)
Extension Cord Reel
(With Stand)



Kablo / Cable ø 3x1.5 mm

| KOD CODE | MODEL | ÖLÇÜ SIZE | g | | TL/Ad. |
|--------------|---------------------|-----------|------|---|--------|
| 07410 50 025 | ayaklı / with stand | 25 | 4130 | 1 | |
| 07410 50 050 | ayaklı / with stand | 50 | 6745 | 1 | |

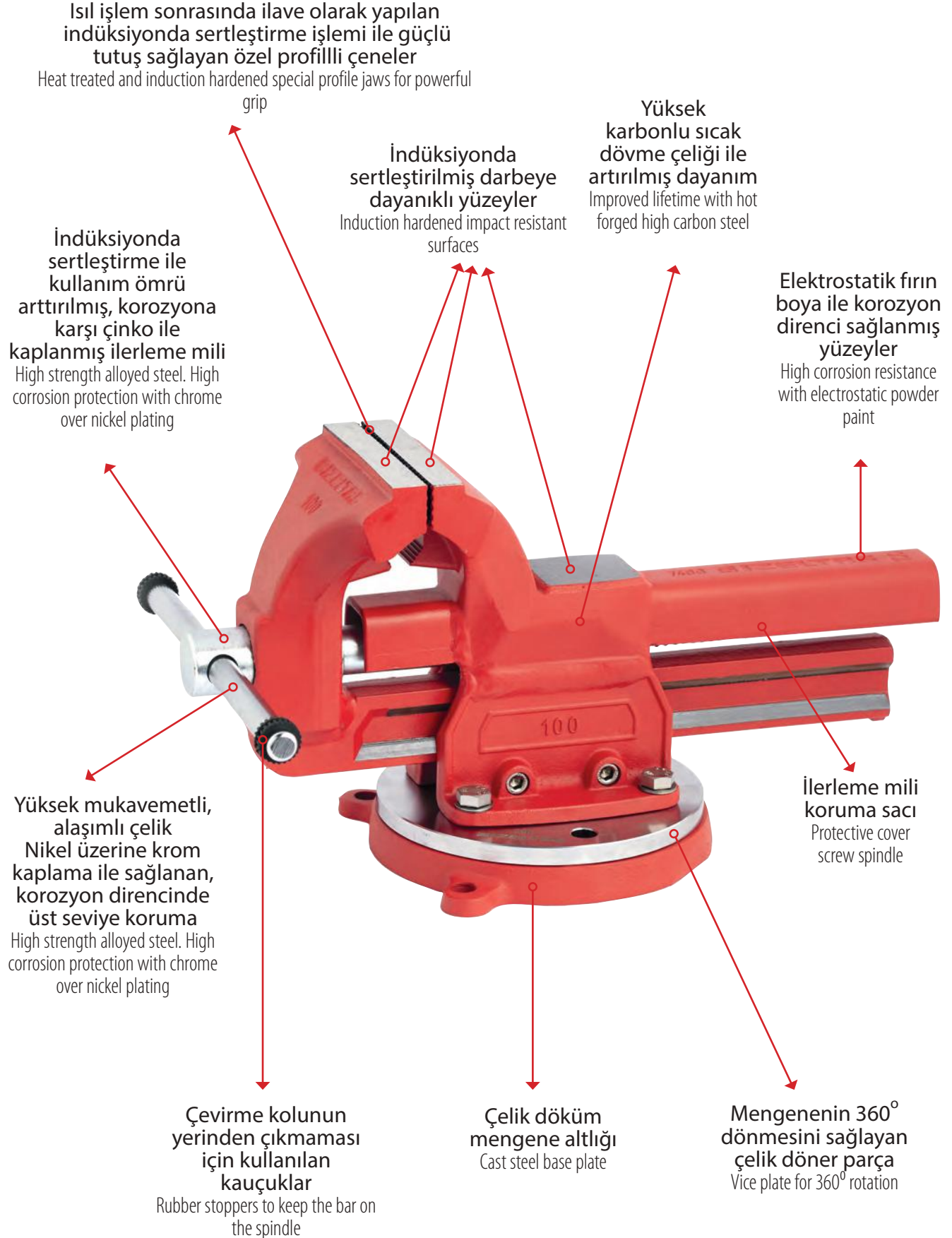

(*) İşaretili olan ürünler stoklarla sınırlıdır.
Limited with stocks.

DÖVME ÇELİK MENGENE/TFORGED STEEL VICE WITH SWIVEL BASE

7401

Mengene Döner Tablası Swivel Base of Vice



Özel alaşım çelik, Krom kaplı
Special steel, Chrom plated

| KOD CODE | ÖLÇÜ SIZE | Ød mm | ØD mm | g | TL/Ad. |
|--------------|--------------|----------|----------|------|--------|
| 7401 30 0100 | 100 | 10.5 | 160 | 1550 | 1 |
| 7401 30 0125 | 125 | 12.5 | 200 | 2700 | 1 |
| 7401 30 0150 | 150 | 12.5 | 240 | 3800 | 1 |
| 7401 30 0175 | 175 | 12.5 | 280 | 6650 | 1 |

7400

Dövme Çelik Mengene Forged Steel Vice



Özel alaşım çelik, Fırın boyalı
Special steel, Electrostatic Paint

| KOD CODE | B mm | W mm | H mm | L mm | g | TL/Ad. |
|--------------|---------|---------|---------|---------|-------|--------|
| 7400 30 0100 | 100 | 125 | 148 | 440 | 5000 | 1 |
| 7400 30 0125 | 125 | 155 | 183 | 550 | 11000 | 1 |
| 7400 30 0150 | 150 | 180 | 220 | 675 | 20000 | 1 |
| 7400 30 0175 | 175 | 205 | 245 | 760 | 29000 | 1 |

7400

Dövme Çelik Mengene (Döner Tabla dahil) Forged Steel Vice with Swivel Base





Özel alaşım çelik, Fırın boyalı
Special steel, Electrostatic Paint

| KOD CODE | B mm | g | TL/Ad. |
|--------------|---------|-------|--------|
| 7400 00 0100 | 100 | 6550 | 1 |
| 7400 00 0125 | 125 | 13700 | 1 |
| 7400 00 0150 | 150 | 23800 | 1 |
| 7400 00 0175 | 175 | 35650 | 1 |



İşkence (Marangoz Mengenesi Plastik Ağızlı)
Carpenter Screw Clamp

Darbeye dayanıklı çeneler
Impact resistant cast iron jaws

| KOD CODE |  | a mm | b mm |  g |  | TL/Ad. |
|--------------|---|------|------|---|---|--------|
| 7300 30 3012 | 30x12 | 300 | 120 | 1605 | 5 | |
| 7300 30 4012 | 40x12 | 400 | 120 | 1780 | 5 | |
| 7300 30 5012 | 50x12 | 500 | 120 | 1935 | 5 | |
| 7300 30 6012 | 60x12 | 600 | 120 | 2080 | 5 | |
| 7300 30 8012 | 80x12 | 800 | 120 | 2470 | 5 | |
| 7300 30 1012 | 100x12 | 1000 | 120 | 2790 | 5 | |

Mini İşkence
Mini Clamp

Alaşımlı alüminyum çeneler
Alloyed aluminum jaws

| KOD CODE |  | a mm | b mm |  g |  | TL/Ad. |
|--------------|--|------|------|---|---|--------|
| 7310 30 1005 | 10x5 | 100 | 50 | 250 | 5 | |
| 7310 30 1505 | 15x5 | 150 | 50 | 280 | 5 | |
| 7310 30 2005 | 20x5 | 200 | 50 | 310 | 5 | |
| 7310 30 2505 | 25x5 | 250 | 50 | 330 | 5 | |
| 7310 30 3005 | 30x5 | 300 | 50 | 360 | 5 | |

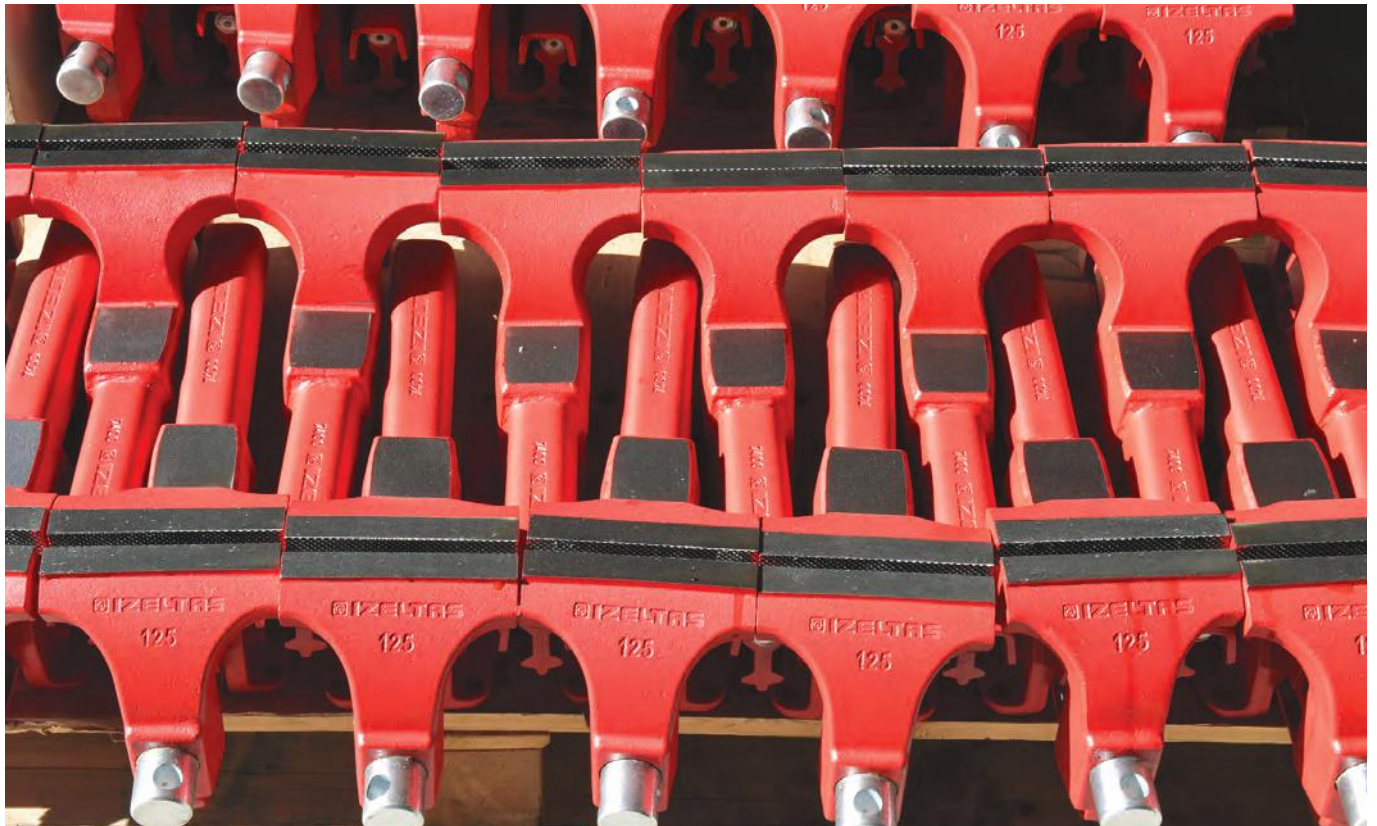

IZELTAS®

MAKASLAR

SHEARS

Demir Kesme Makası
Bolt Cutters

Saç Makasları
Sheet Metal Cutters

Plastik Boru Kesme Makası
Plastic Pipe Cutters

Bağ Makasları
Prunnig Shears



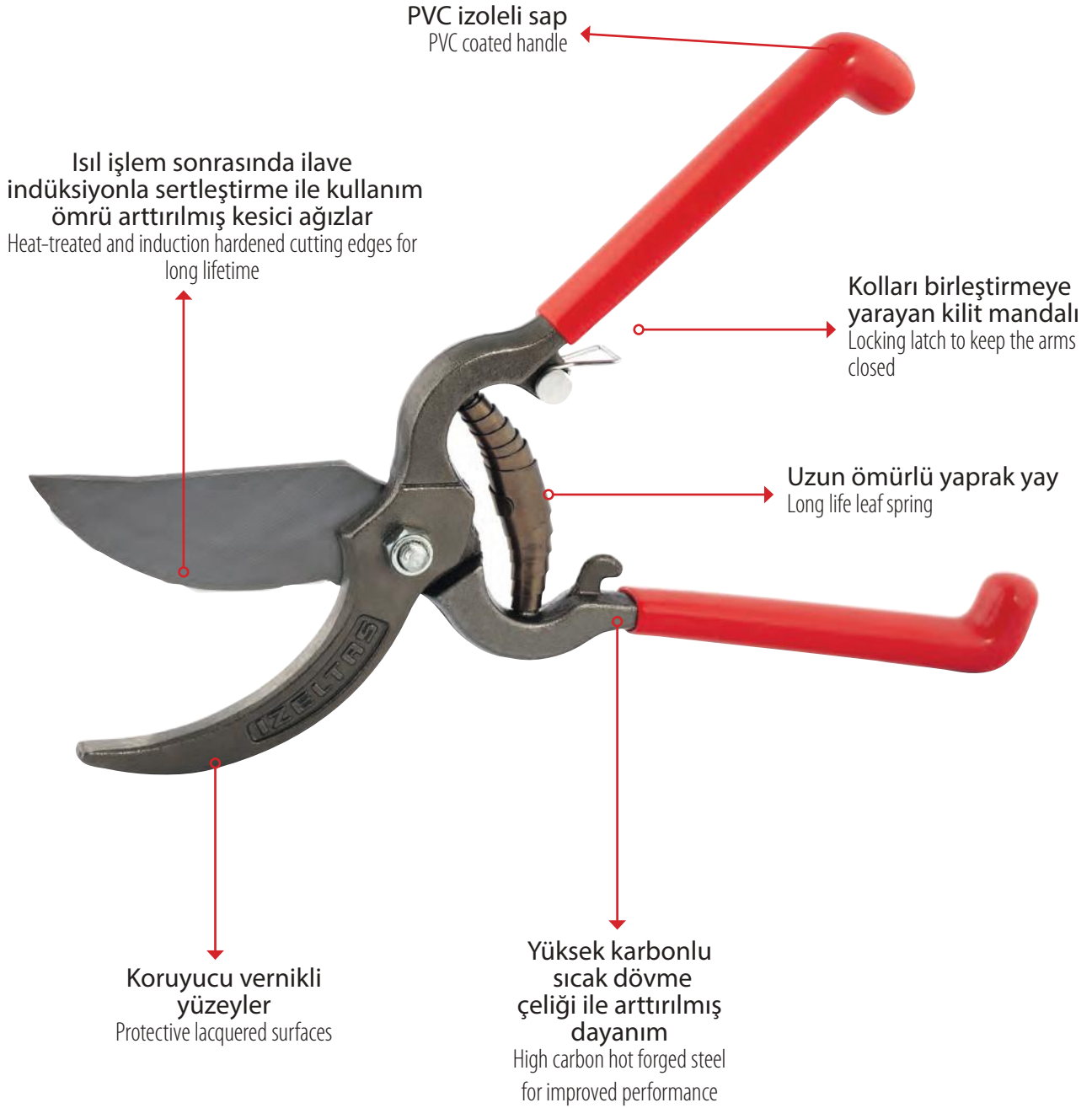

İZELTAS YOUTUBE

(★) İşaretili olan ürünler stoklarla sınırlıdır.
Limited with stocks.

2350

Demir Kesme Makası Bolt Cutters



 Yedek parça sayfa 198
Spare parts page 198

Özel alaşımlı çelik, Kesici ağızlar indüksiyonda sertleştirilmiş,
Elektrostatik boyanmış çeneler ve bağlantı parçaları dövme
Special steel, Cutters induction hardened,
Electrostatically painted jaws and connection parts drop forged

| KOD CODE | L mm | L inch | KAPASİTE CAPACITY Ø mm | g | TL/Ad. |
|--------------|---------|-----------|------------------------------|------|--------|
| 2350 27 0018 | 450 | 18" | 6 - 8 | 1510 | 1 |
| 2350 27 0024 | 600 | 24" | 8 - 10 | 2350 | 1 |
| 2350 27 0030 | 750 | 30" | 9 - 13 | 3750 | 1 |
| 2350 27 0036 | 900 | 36" | 11 - 16 | 5500 | 1 |

2350

Demir Kesme Makası Sehpa (Dolu) Bolt Cutters Frame



| KOD CODE | İÇERİK CONTENTS | g | TL/Ad. |
|--------------|--|--------|--------|
| 2350 00 6104 | 18"(450) - 24"(600) 30"(750) - 36"(900) | 21.110 | 4 |

6205

Alüminyum Ve Sac Kesme Makası Sağ Snip For Aluminum and Metal Sheet (Right)



Özel alaşımlı çelik, Kesici ağızlar indüksiyonda sertleştirilmiş,
Special steel, Cutters induction hardened,

| KOD CODE | L mm | L inch | g | TL/Ad. |
|--------------|---------|-----------|-----|--------|
| 6205 27 0240 | 240 | 10" | 380 | 5 |

6206

Alüminyum Ve Sac Kesme Makası Sol Snip For Aluminum and Metal Sheet (Left)



Özel alaşımlı çelik, Kesici ağızlar indüksiyonda sertleştirilmiş
Special steel, Cutters induction hardened

| KOD CODE | L mm | L inch | g | TL/Ad. |
|--------------|---------|-----------|-----|--------|
| 6206 27 0240 | 240 | 10" | 380 | 5 |

6207

Alüminyum Ve Sac Kesme Makası Düz Snip For Aluminum and Metal Sheet (Flat)



Özel alaşımlı çelik, Kesici ağızlar indüksiyonda sertleştirilmiş
Special steel, Cutters induction hardened

| KOD CODE | L mm | L inch | g | TL/Ad. |
|--------------|---------|-----------|-----|--------|
| 6207 27 0240 | 240 | 10" | 380 | 5 |

(★) İşaretili olan ürünler stoklarla sınırlıdır.
Limited with stocks.

6210**Kaportacı Makası (Sağ)**
Punch Snip (Right)

DIN 6438



Özel alaşımlı çelik, Kesici ağızlar induksiyonda sertleştirilmiş, PVC izoleli
Special steel, Cutters induction hardened, PVC insulated

| KOD CODE | L mm | L inch | g | TL/Ad. |
|--------------|---------|-----------|-----|--------|
| 6210 27 0250 | 250 | 10" | 555 | 5 |
| 6210 27 0275 | 275 | 11" | 600 | 5 |
| 6210 27 0300 | 300 | 12" | 640 | 5 |

6211**Kaportacı Makası (Sol)**
Punch Snip (Left)

DIN 6438



Özel alaşımlı çelik, Kesici ağızlar induksiyonda sertleştirilmiş, PVC izoleli
Special steel, Cutters induction hardened, PVC insulated

| KOD CODE | L mm | L inch | g | TL/Ad. |
|--------------|---------|-----------|-----|--------|
| 6211 27 0250 | 250 | 10" | 535 | 5 |
| 6211 27 0275 | 275 | 11" | 605 | 5 |
| 6211 27 0300 | 300 | 12" | 665 | 5 |

6820**Tenekeci Makası**
Tinman's Snip

TSEK



Özel alaşımlı çelik, Kesici ağızlar induksiyonda sertleştirilmiş, PVC izoleli
Special steel, Cutters induction hardened, PVC insulated

| KOD CODE | L mm | L inch | g | TL/Ad. |
|--------------|---------|-----------|-----|--------|
| 6820 27 0200 | 200 | 8" | 320 | 5 |
| 6820 27 0250 | 250 | 10" | 575 | 5 |
| 6820 27 0300 | 300 | 12" | 870 | 5 |

6821**Tenekeci Makası (Yaylı)**
Tinman's Snip (With Spring)

TSEK



Özel alaşımlı çelik, Kesici ağızlar induksiyonda sertleştirilmiş, PVC izoleli
Special steel, Cutters induction hardened, PVC insulated

| KOD CODE | L mm | L inch | g | TL/Ad. |
|--------------|---------|-----------|-----|--------|
| 6821 27 0250 | 250 | 10" | 575 | 5 |
| 6821 27 0300 | 300 | 12" | 895 | 5 |

6800

Kuyumcu Makası (Düz)
Jeweller's Snip (Straight)

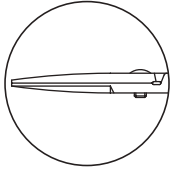

| KOD CODE | L mm | L inch | g | TL/Ad. |
|--------------|------|--------|-----|--------|
| 6800 27 0180 | 180 | 7 1/8" | 140 | 5 |

6815

Tel Kesme Makası
Bolt Cutters



| KOD CODE | L mm | L inch | g | TL/Ad. |
|--------------|------|--------|-----|--------|
| 6815 27 0200 | 200 | 8" | 295 | 5 |

6801

Kuyumcu Makası (Eğri)
Jeweller's Snip (Curved)

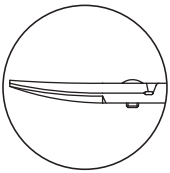

| KOD CODE | L mm | L inch | g | TL/Ad. |
|--------------|------|--------|-----|--------|
| 6801 27 0180 | 180 | 7 1/8" | 140 | 5 |

6740

Kombine Makas
Multi Purpose Scissors



| KOD CODE | L mm | L inch | g | TL/Ad. |
|--------------|------|--------|-----|--------|
| 6740 27 0140 | 140 | 5 1/2" | 60 | 5 |
| 6740 27 0190 | 190 | 7 1/2" | 120 | 5 |

6710**Bağ Makası (Lüks)**
Pruning Shears (Lux)

İZELTAS YOUTUBE

Özel alaşımlı çelik, Kesici ağızlar indüksiyonda sertleştirilmiş, PVC izoleli
Special steel, Cutters induction hardened, PVC insulated

| KOD CODE | L mm | L inch | g | TL/Ad. |
|--------------|---------|-----------|-----|--------|
| 6710 27 0230 | 230 | 9" | 390 | 5 |

6720**Bağ Makası (Hafif Tip)**
Pruning Shears (Light)

Alüminyum gövde, PVC izoleli
Aluminum forged body, PVC insulated

| KOD CODE | L mm | L inch | g | TL/Ad. |
|--------------|---------|-----------|-----|--------|
| 6720 27 0220 | 220 | 8 5/8" | 265 | 5 |

6715**Bağ Makası (Comfort)**
Pruning Shears (Comfort)

Özel alaşımlı çelik, PVC izoleli
Special steel, PVC insulated

| KOD CODE | L mm | L inch | g | TL/Ad. |
|--------------|---------|-----------|-----|--------|
| 6715 27 0225 | 225 | 9" | 340 | 5 |

6712**Elma Makası**
Pruning Shears (Fruit)

Özel alaşımlı çelik, Kesici ağızlar indüksiyonda sertleştirilmiş, PVC izoleli
Special steel, Cutters induction hardened, PVC insulated

| KOD CODE | L mm | L inch | g | TL/Ad. |
|--------------|---------|-----------|-----|--------|
| 6712 27 0210 | 210 | 8 1/4" | 365 | 5 |

06760

Plastik Boru Kesme Makası
Plastic Pipe Cutter



 Yedek parça sayfa 200
Spare parts page 200

| KOD CODE | Ø mm | g | | TL/Ad. |
|--------------|------|-----|---|--------|
| 06760 50 042 | 42 | 400 | 5 | |
| 06760 50 063 | 63 | 610 | 5 | |

6860

Teleskopik Boru Kesici (Bakır ve Alüminyum İçin)
Telescopic Tube Cutter (For Copper and Aluminum)



 Yedek parça sayfa 200
Spare parts page 200

| KOD CODE | ÖLÇÜ SIZE | g | | TL/Ad. |
|--------------|---------------|-----|---|--------|
| 6860 28 0635 | 1/4" - 1 3/8" | 470 | 1 | |

6850

Mini Boru Kesici (Bakır ve Alüminyum İçin)
Mini Tube Cutter (For Copper and Aluminum)



 Yedek parça sayfa 200
Spare parts page 200

| KOD CODE | ÖLÇÜ SIZE | g | | TL/Ad. |
|--------------|-------------|-----|---|--------|
| 6850 28 0322 | 1/8" - 5/8" | 120 | 1 | |

6865

Profesyonel Boru Kesici (Çelik İçin)
Professional Tube Cutter (For Steel)



 Yedek parça sayfa 200
Spare parts page 200

| KOD CODE | ÖLÇÜ SIZE | g | | TL/Ad. |
|--------------|-----------|------|---|--------|
| 6865 28 1050 | 1/8" - 2" | 2380 | 1 | |

6855

Standart Boru Kesici (Bakır ve Alüminyum İçin)
Standard Tube Cutter (For Copper and Aluminum)



 Yedek parça sayfa 200
Spare parts page 200

| KOD CODE | ÖLÇÜ SIZE | g | | TL/Ad. |
|--------------|---------------|-----|---|--------|
| 6855 28 0330 | 1/8" - 1 1/8" | 305 | 1 | |



(*) İşaretili olan ürünler stoklarla sınırlıdır.
Limited with stocks.



IZELTAS®

ÇEKTİRMELER

PULLERS

Çektirmeler
Pullers

İç Rulman Çektirmeler
Inside Pullers

Rotil Çektirmeler
Balljoint Pullers

Saplama Sökmeler
Stud Inserters and Removers



PULLERS

ÇEKTİRMELER

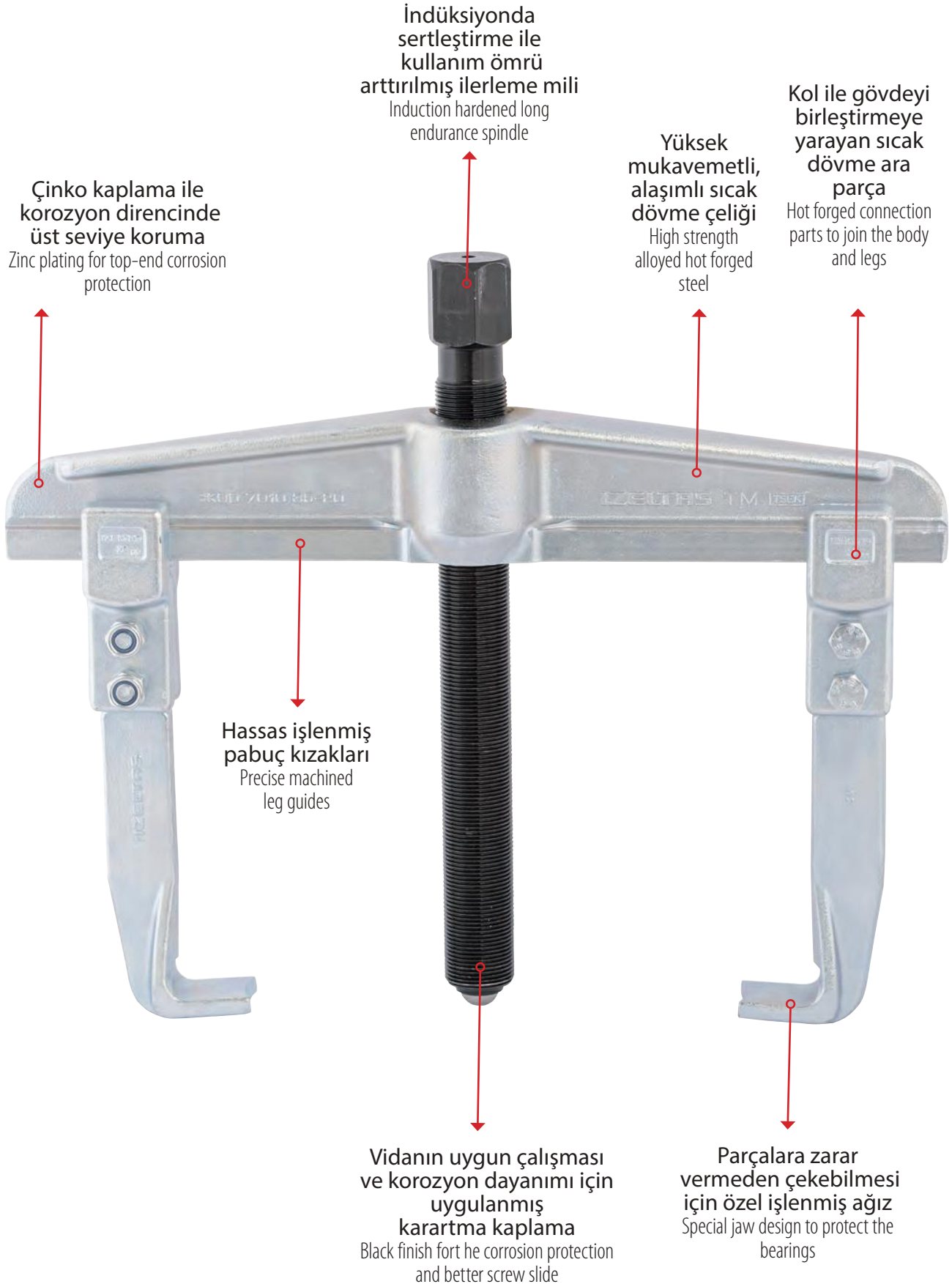

7010

Standart Çektirme (İki Kollu) Standard Puller (Two Arms)

TSEK

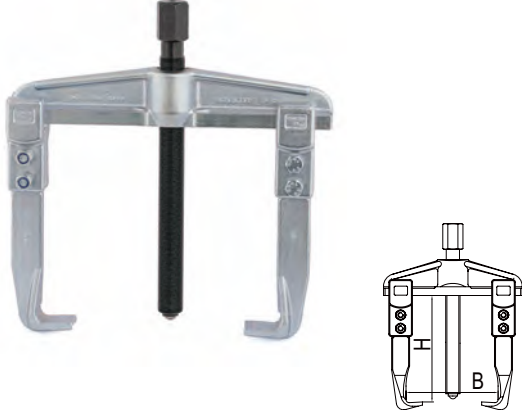

Yedek parça sayfa 201
Spare parts page 201

Krom vanadyum, Çinko kaplı, Kollar sertleştirilmiş,
Mil indüksiyonda sertleştirilmiş
Chrom vanadium, Zinc plated,
Arms hardened, Spindle induction hardened

| KOD CODE | | B mm | H mm | g | | TL/Ad. |
|--------------|-------|------|------|-------|---|--------|
| 7010 29 0810 | 8x10 | 80 | 100 | 1080 | 1 | |
| 7010 29 1210 | 12x10 | 120 | 100 | 1235 | 1 | |
| 7010 29 1615 | 16x15 | 160 | 150 | 2850 | 1 | |
| 7010 29 2015 | 20x15 | 200 | 150 | 3060 | 1 | |
| 7010 29 2520 | 25x20 | 250 | 200 | 7450 | 1 | |
| 7010 29 3520 | 35x20 | 350 | 200 | 10000 | 1 | |
| 7010 29 5220 | 52x20 | 520 | 200 | 14100 | 1 | |

7010

Standart Çektirme Sehpası (Dolu) Display Frame For Pullers



| KOD CODE | İÇERİK CONTENTS | g | | TL/Ad. |
|--------------|---------------------------------------|-------|---|--------|
| 7010 00 6105 | 8x10 - 12x10 - 16x15 20x15 - 25x20 | 17840 | 5 | |

7020

Standart Çektirme (Üç Kollu) Standart Puller (Three Arms)

TSEK

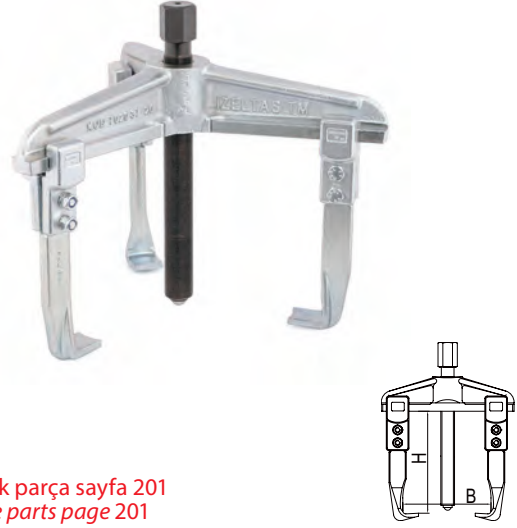

Yedek parça sayfa 201
Spare parts page 201

Krom vanadyum, Çinko kaplı, Kollar sertleştirilmiş,
Mil indüksiyonda sertleştirilmiş
Chrom vanadium, Zinc plated,
Arms hardened, Spindle induction hardened

| KOD CODE | | B mm | H mm | g | | TL/Ad. |
|--------------|-------|------|------|-------|---|--------|
| 7020 29 3720 | 37x20 | 370 | 200 | 14750 | 1 | |
| 7020 29 5220 | 52x20 | 520 | 200 | 20000 | 1 | |



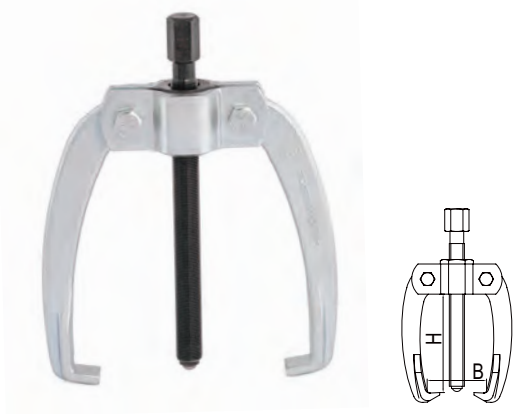

(*) İşaretili olan ürünler stoklarla sınırlıdır.
Limited with stocks.

7030
Master Çektirme (İki Kollu)
Master Puller (Two Arms)
TSEK

 **Yedek parça sayfa 201**
Spare parts page 201

**Krom vanadyum, Çinko kaplı, Kollar sertleştirilmiş,
 Mil indüksiyonda sertleştirilmiş**
*Chrom vanadium, Zinc plated,
 Arms hardened, Spindle induction hardened*

| KOD CODE |  | B mm | H mm |  g |  | TL/Ad. |
|--------------|---|------|------|---|---|--------|
| 7030 29 0808 | 8x8 | 80 | 80 | 545 | 1 | |
| 7030 29 1212 | 12x12 | 120 | 120 | 1075 | 1 | |
| 7030 29 1616 | 16x16 | 160 | 160 | 1885 | 1 | |
| 7030 29 2320 | 23x20 | 230 | 200 | 3240 | 1 | |

7040
Master Çektirme (Üç Kollu)
Master Puller (Three Arms)
TSEK

 **Yedek parça sayfa 201**
Spare parts page 201

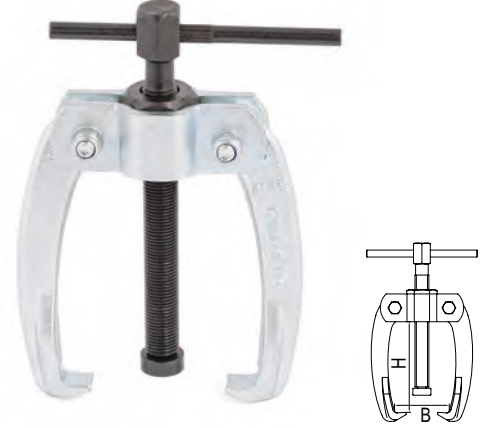

**Krom vanadyum, Çinko kaplı, Kollar sertleştirilmiş,
 Mil indüksiyonda sertleştirilmiş**
*Chrom vanadium, Zinc plated,
 Arms hardened, Spindle induction hardened*

| KOD CODE |  | B mm | H mm |  g |  | TL/Ad. |
|--------------|---|------|------|---|---|--------|
| 7040 29 0808 | 8x8 | 80 | 80 | 680 | 1 | |
| 7040 29 1212 | 12x12 | 120 | 120 | 1355 | 1 | |
| 7040 29 1616 | 16x16 | 160 | 160 | 2320 | 1 | |
| 7040 29 2320 | 23x20 | 230 | 200 | 4025 | 1 | |

7050
Batarya Çektirme (İki Kollu)
Battery Puller (Two Arms)
TSEK

 **Yedek parça sayfa 201**
Spare parts page 201



**Krom vanadyum, Çinko kaplı, Kollar sertleştirilmiş,
 Mil indüksiyonda sertleştirilmiş**
*Chrom vanadium, Zinc plated,
 Arms hardened, Spindle induction hardened*

| KOD CODE |  | B mm | H mm |  g |  | TL/Ad. |
|--------------|---|------|------|---|---|--------|
| 7050 29 0604 | 6x4 | 60 | 40 | 245 | 1 | |
| 7050 29 0606 | 6x6 | 60 | 60 | 275 | 1 | |
| 7050 29 0808 | 8x8 | 80 | 80 | 555 | 1 | |

7060
Batarya Çektirme (Üç Kollu)
Battery Puller (Three Arms)
TSEK

 **Yedek parça sayfa 201**
Spare parts page 201

**Krom vanadyum, Çinko kaplı, Kollar sertleştirilmiş,
 Mil indüksiyonda sertleştirilmiş**
*Chrom vanadium, Zinc plated,
 Arms hardened, Spindle induction hardened*

| KOD CODE |  | B mm | H mm |  g |  | TL/Ad. |
|--------------|---|------|------|---|---|--------|
| 7060 29 0604 | 6x4 | 60 | 40 | 300 | 1 | |
| 7060 29 0606 | 6x6 | 60 | 60 | 345 | 1 | |
| 7060 29 0808 | 8x8 | 80 | 80 | 715 | 1 | |

7070

S Tipi Çektirme (İki Kollu)
S Type Puller (Two Arms)

TSEK

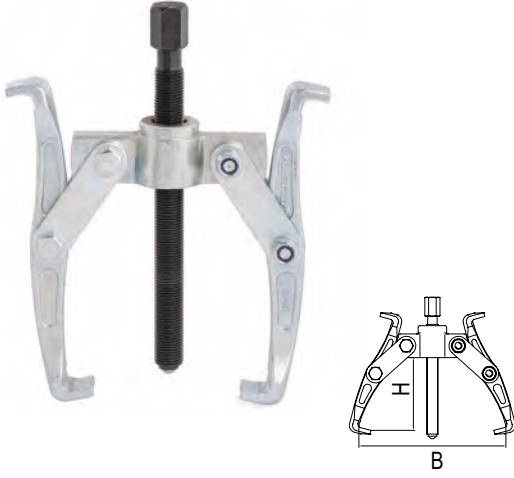

Yedek parça sayfa 201
Spare parts page 201

Krom vanadyum, Çinko kaplı, Kollar sertleştirilmiş,
Mil indüksiyonda sertleştirilmiş
Chrom vanadium, Zinc plated,
Arms hardened, Spindle induction hardened

| KOD CODE | | B mm | H mm | g | TL/Ad. |
|--------------|-------|------|------|------|--------|
| 7070 29 2013 | 20x13 | 200 | 130 | 2420 | 1 |

7090

Üniversal Çektirme (İki Kollu)
Universal Puller (Two Arms)

TSEK

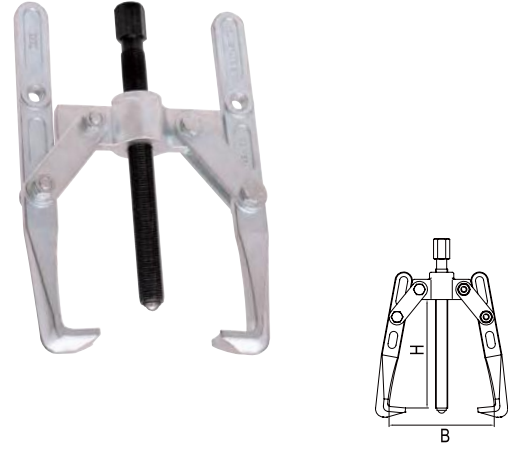

Yedek parça sayfa 201
Spare parts page 201

Krom vanadyum, Çinko kaplı, Kollar sertleştirilmiş,
Mil indüksiyonda sertleştirilmiş
Chrom vanadium, Zinc plated,
Arms hardened, Spindle induction hardened

| KOD CODE | | B mm | H mm | g | TL/Ad. |
|--------------|-------|------|------|------|--------|
| 7090 29 2222 | 22x22 | 220 | 220 | 3085 | 1 |

7080

S Tipi Çektirme (Üç Kollu)
S Type Puller (Three Arms)

TSEK

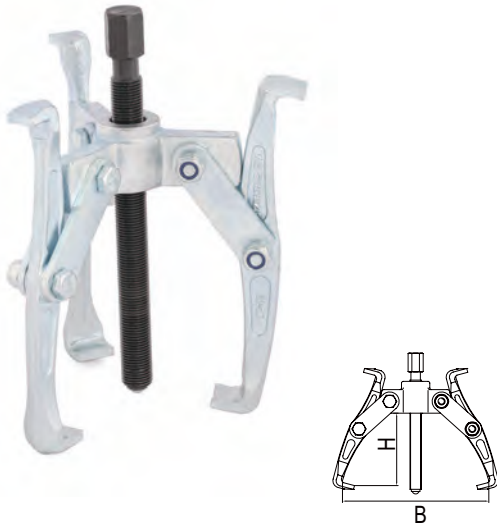

Yedek parça sayfa 201
Spare parts page 201

Krom vanadyum, Çinko kaplı, Kollar sertleştirilmiş,
Mil indüksiyonda sertleştirilmiş
Chrom vanadium, Zinc plated,
Arms hardened, Spindle induction hardened

| KOD CODE | | B mm | H mm | g | TL/Ad. |
|--------------|-------|------|------|------|--------|
| 7080 29 2013 | 20x13 | 200 | 130 | 3250 | 1 |

7100

Üniversal Çektirme (Üç Kollu)
Universal Puller (Three Arms)

TSEK



Yedek parça sayfa 201
Spare parts page 201

Krom vanadyum, Çinko kaplı, Kollar sertleştirilmiş,
Mil indüksiyonda sertleştirilmiş
Chrom vanadium, Zinc plated,
Arms hardened, Spindle induction hardened

| KOD CODE | | B mm | H mm | g | TL/Ad. |
|--------------|-------|------|------|------|--------|
| 7100 29 2222 | 22x22 | 220 | 220 | 4125 | 1 |

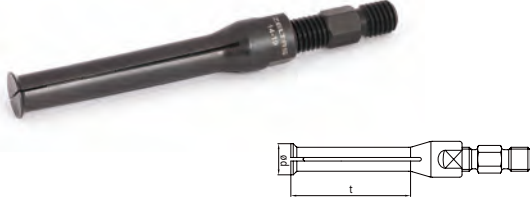
İç Rulman Çektirme Pensleri - Model A
Internal Expansion Puller - Model A

| KOD CODE | øD mm | t mm | Kullanılan Kol / For | Adaptör vidası | g | TL/Ad. |
|--------------|---------|------|----------------------|----------------|-----|--------|
| 7120 29 0507 | 5 - 7 | 30 | 35 - 75 | M10 | 40 | 1 |
| 7120 29 0709 | 7 - 9 | 30 | 35 - 75 | M10 | 40 | 1 |
| 7120 29 0912 | 9 - 12 | 30 | 35 - 75 | M10 | 40 | 1 |
| 7120 29 1013 | 10 - 13 | 30 | 35 - 75 | M10 | 40 | 1 |
| 7120 29 1317 | 13 - 17 | 50 | 35 - 75 | M10 | 60 | 1 |
| 7120 29 1419 | 14 - 19 | 60 | 35 - 75 | M10 | 75 | 1 |
| 7120 29 1621 | 16 - 21 | 60 | 35 - 75 | M10 | 75 | 1 |
| 7120 29 1823 | 18 - 23 | 60 | 35 - 75 | M10 | 100 | 1 |
| 7120 29 2025 | 20 - 25 | 60 | 35 - 75 | M10 | 100 | 1 |
| 7120 29 2530 | 25 - 30 | 60 | 35 - 75 | M10 | 110 | 1 |
| 7120 29 3037 | 30 - 37 | 70 | 35 - 75 60 - 130 | M10 | 250 | 1 |
| 7120 29 3542 | 35 - 42 | 70 | 35 - 75 60 - 130 | M10 | 250 | 1 |
| 7120 29 3845 | 38 - 45 | 70 | 35 - 75 60 - 130 | M10 | 250 | 1 |
| 7120 29 4350 | 43 - 50 | 70 | 35 - 75 60 - 130 | M10 | 400 | 1 |

İç Rulman Çektirme Pensleri - Model B
Internal Expansion Puller - Model B

| KOD CODE | øD mm | t mm | Kullanılan Kol / For | Adaptör vidası | g | TL/Ad. |
|--------------|---------|------|----------------------|----------------|-----|--------|
| 7120 29 2540 | 25 - 40 | 45 | 35 - 75 60 - 130 | M10 | 235 | 1 |

İç Rulman Çektirme Kolları
Arms For Internal Expansion Puller

Krom vanadyum, Çinko kaplı, Kollar sertleştirilmiş,
Mil indüksiyonda sertleştirilmiş
Chrom vanadium, Zinc plated,
Arms hardened, Spindle induction hardened

| KOD CODE | Kapasite Capacity mm | Kullanılan pensler / For | Adaptör vidası Screw Adapter | g | TL/Ad. |
|----------|----------------------|--------------------------|------------------------------|---|--------|
|----------|----------------------|--------------------------|------------------------------|---|--------|

| | | | | | |
|--------------|---------|--|-----|-----|---|
| 7120 29 3575 | 35 - 75 | Model A 5 - 7'den 43 - 50'ye Model B 25 - 40 | M10 | 625 | 1 |
|--------------|---------|--|-----|-----|---|

| | | | | | |
|--------------|----------|--|-----|------|---|
| 7120 29 6013 | 60 - 130 | Model A 30 - 37'den 43 - 50'ye Model B 25 - 40 | M10 | 1000 | 1 |
|--------------|----------|--|-----|------|---|



7122
Dış Rulman Çektirme Çeneleri
Separator

Krom vanadyum, Çinko kaplı, Kollar sertleştirilmiş,
 Mil indüksiyonda sertleştirilmiş
*Chrom vanadium, Zinc plated,
 Arms hardened, Spindle induction hardened*

| KOD CODE | Ø mm | Kullanılan Kollar / For | Adaptör vidası | g | TL/Ad. |
|--------------|----------|-------------------------|----------------|-------|--------|
| 7122 29 0560 | 5 - 60 | 40 - 115 | M12 | 370 | 1 |
| 7122 29 1275 | 12 - 75 | 40 - 115 | M12 | 635 | 1 |
| 7122 29 2211 | 22 - 115 | 55 - 205 | M16 | 1780 | 1 |
| 7122 29 2515 | 25 - 155 | 90 - 260 | M20x1.5 | 3940 | 1 |
| 7122 29 3022 | 30 - 220 | 100 - 360 | M20x1.5 | 11000 | 1 |
| 7122 29 4028 | 40 - 280 | 140 - 435 | M24x3 | 15000 | 1 |

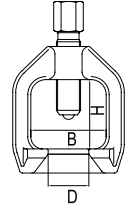
7126
Rotil Çektirme
Extractor For Ball Joint

| KOD CODE | σD mm | B mm | H mm | g | TL/Ad. |
|--------------|-------|------|------|------|--------|
| 7126 29 0018 | 18 | 40 | 40 | 315 | 1 |
| 7126 29 0025 | 25 | 50 | 50 | 540 | 1 |
| 7126 29 0029 | 29 | 60 | 60 | 915 | 1 |
| 7126 29 0040 | 40 | 80 | 80 | 1965 | 1 |
| 7126 29 0045 | 45 | 90 | 100 | 2670 | 1 |

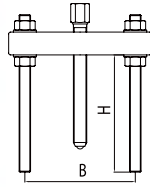
7122
Dış Rulman Çektirme Kolları
Puller Arms For Separator

Krom vanadyum, Çinko kaplı, Kollar sertleştirilmiş,
 Mil indüksiyonda sertleştirilmiş
*Chrom vanadium, Zinc plated,
 Arms hardened, Spindle induction hardened*

| KOD CODE | B mm | H mm | Kullanılan Çene / For | Adaptör vidası | g | TL/Ad. |
|--------------|---------|------|-----------------------|----------------|-------|--------|
| 7122 29 4011 | 40-115 | 150 | 5 - 60 12 - 75 | M12 | 990 | 1 |
| 7122 29 5520 | 55-205 | 210 | 22 - 115 | M16 | 2700 | 1 |
| 7122 29 9026 | 90-260 | 315 | 25 - 155 | M20x1.5 | 4965 | 1 |
| 7122 29 1036 | 100-360 | 305 | 30 - 220 | M20x1.5 | 7000 | 1 |
| 7122 29 1443 | 140-435 | 320 | 40 - 280 | M24x3 | 11000 | 1 |



(*) İşaretili olan ürünler stoklarla sınırlıdır.
Limited with stocks.



IZELTAS®

elta

Anahtarlar
Wrenches

Tornavida ve Allen Anahtarlar
Screwdrivers and Hex Key Wrenches

Lokma Anahtarları
Sockets Wrenches

Keskiler
Chisels

Boru Anahtarları ve Penseler
Pipe Wrenches and Pliers

Makaslar
Shears

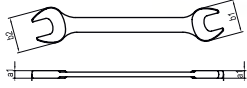

elta

0150
İki Ağız Anahtar (mm)
Double Ended Open Jaw Wrench (mm)

Krom vanadyum, Krom kaplı
Chrom vanadium, Chrom plated

| KOD CODE | mm | L mm | a1 mm | b1 mm | b2 mm | g | TL/Ad. |
|--------------|-------|------|-------|-------|-------|-----|----------|
| 0150 01 0607 | 6x7 | 98 | 3.3 | 13.5 | 15.5 | 10 | 10 |
| 0150 01 0809 | 8x9 | 108 | 3.6 | 17.5 | 19.5 | 20 | 10 |
| 0150 01 1011 | 10x11 | 120 | 4.1 | 21.5 | 23.5 | 30 | 10 |
| 0150 01 1213 | 12x13 | 134 | 4.5 | 25.5 | 27.5 | 40 | 10 |
| 0150 01 1415 | 14x15 | 150 | 5 | 29.5 | 31.5 | 60 | 10 |
| 0150 01 1617 | 16x17 | 163 | 5.5 | 33.5 | 35.5 | 85 | 10 |
| 0150 01 1819 | 18x19 | 178 | 6 | 37.5 | 39.5 | 110 | 10 |
| 0150 01 2022 | 20x22 | 198 | 6.5 | 41.5 | 45.5 | 145 | 10 |
| 0150 01 2123 | 21x23 | 218 | 6.9 | 43.5 | 47.5 | 175 | 10 |
| 0150 01 2426 | 24x26 | 236 | 7.4 | 49.5 | 53.5 | 235 | 10 |
| 0150 01 2528 | 25x28 | 250 | 7.8 | 51.5 | 57.5 | 275 | 10 |
| 0150 01 2732 | 27x32 | 265 | 8.3 | 55.5 | 65.5 | 345 | 10 67,40 |

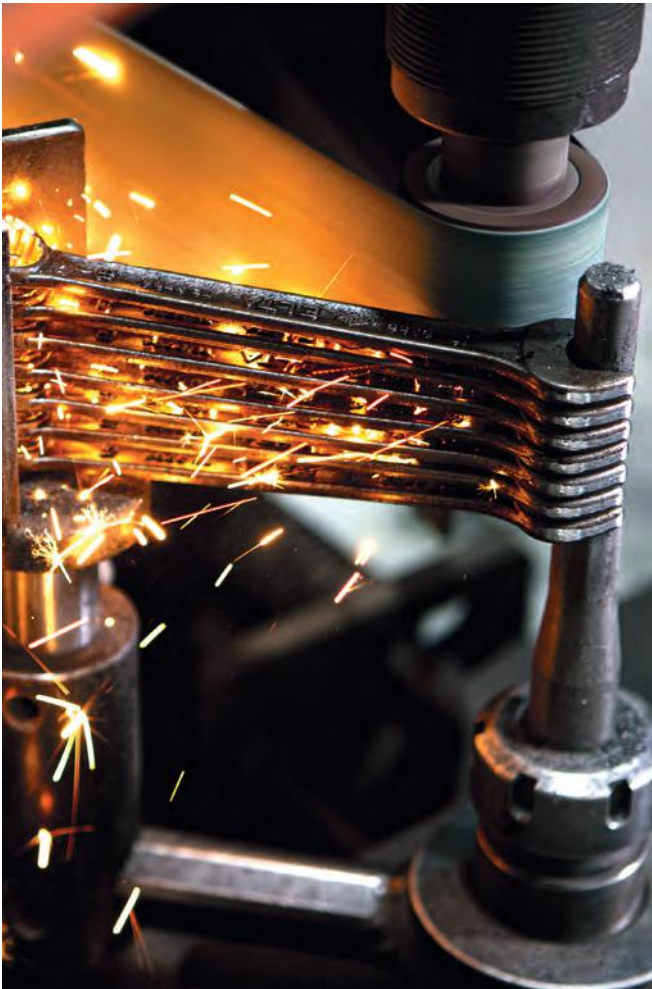
0150
İki Ağız Anahtar Takımı (mm)
Double Ended Open Jaw Wrench Set (mm)

| KOD CODE | İÇERİK CONTENTS | g | TL/Ad. |
|--------------|--|------|--------|
| 0150 00 2108 | 6x7 - 8x9 - 10x11 12x13 - 14x15 - 16x17 18x19 - 20x22 | 560 | 8 |
| 0150 00 2112 | 6x7 - 8x9 - 10x11 12x13 - 14x15 - 16x17 18x19 - 20x22 - 21x23 24x26 - 25x28 - 27x32 | 1590 | 12 |

(*) İşaretili olan ürünler stoklarla sınırlıdır.
Limited with stocks.

Kombine Anahtar (mm)
Combination Wrench (mm)

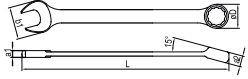
 TS 3794
 TS ISO 7738 Form A
 DIN 3113

 Krom vanadyum, Krom kaplı
Chrom vanadium, Chrom plated

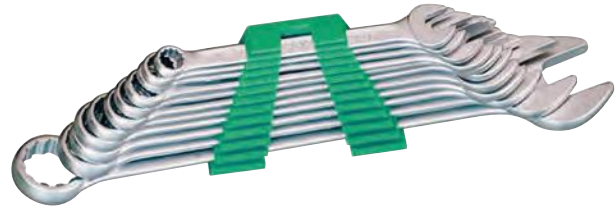
| KOD CODE | mm | L mm | a1 mm | a2 mm | b1 mm | øD mm | g | TL/Ad. |
|--------------|----|------|-------|-------|-------|-------|-----|--------|
| 0350 02 0006 | 6 | 95 | 3.1 | 5.1 | 13.5 | 10 | 15 | 10 |
| 0350 02 0007 | 7 | 104 | 3.3 | 5.5 | 15.5 | 11.5 | 15 | 10 |
| 0350 02 0008 | 8 | 112 | 3.7 | 5.9 | 17.5 | 13 | 20 | 10 |
| 0350 02 0009 | 9 | 121 | 3.9 | 6.3 | 19.5 | 14 | 25 | 10 |
| 0350 02 0010 | 10 | 130 | 4.3 | 6.9 | 21.5 | 15.5 | 30 | 10 |
| 0350 02 0011 | 11 | 138 | 4.5 | 7.3 | 23.5 | 16.5 | 35 | 10 |
| 0350 02 0012 | 12 | 146 | 4.9 | 7.7 | 25.5 | 18 | 45 | 10 |
| 0350 02 0013 | 13 | 154 | 5.1 | 8.1 | 27.5 | 19 | 50 | 10 |
| 0350 02 0014 | 14 | 163 | 5.5 | 8.7 | 29.5 | 21.5 | 60 | 10 |
| 0350 02 0015 | 15 | 171 | 5.7 | 9.1 | 31.5 | 22 | 70 | 10 |
| 0350 02 0016 | 16 | 180 | 6.1 | 9.5 | 33.5 | 23 | 85 | 10 |
| 0350 02 0017 | 17 | 189 | 6.3 | 9.9 | 35.5 | 25 | 95 | 10 |
| 0350 02 0018 | 18 | 200 | 6.7 | 10.4 | 37.5 | 26.5 | 110 | 10 |
| 0350 02 0019 | 19 | 211 | 6.9 | 11 | 39.5 | 28 | 130 | 10 |
| 0350 02 0020 | 20 | 222 | 7.3 | 11.4 | 41.5 | 29.5 | 145 | 10 |
| 0350 02 0021 | 21 | 235 | 7.3 | 11.4 | 43.5 | 31 | 160 | 10 |
| 0350 02 0022 | 22 | 250 | 8.1 | 12.6 | 45.5 | 32.5 | 200 | 10 |
| 0350 02 0024 | 24 | 270 | 8.7 | 13.6 | 49.5 | 36 | 250 | 5 |
| 0350 02 0027 | 27 | 300 | 9.6 | 14.8 | 55.5 | 40 | 350 | 5 |
| 0350 02 0030 | 30 | 330 | 10.2 | 15.8 | 61.5 | 44.5 | 445 | 5 |
| 0350 02 0032 | 32 | 350 | 10.4 | 16.2 | 65.5 | 47 | 500 | 5 |

0350
Kombine Anahtar Takımı (mm)
Combination Wrench Set (mm)

| KOD CODE | İÇERİK CONTENTS | g | TL/Ad. |
|--------------|--|------|--------|
| 0350 00 2108 | 6 - 7 - 8 - 9 - 10 - 13 17 - 19 | 395 | 8 |
| 0350 00 2112 | 8 - 9 - 10 - 11 - 12 13 - 14 - 15 - 16 17 - 19 - 22 | 855 | 12 |
| 0350 00 2117 | 6 - 7 - 8 - 9 - 10 11 - 12 - 13 - 14 15 - 16 - 17 - 18 19 - 20 - 21 - 22 | 1300 | 17 |
| 0350 00 2121 | 6 - 7 - 8 - 9 - 10 11 - 12 - 13 - 14 15 - 16 - 17 - 18 19 - 20 - 21 - 22 24 - 27 - 30 - 32 | 2810 | 21 |

 (★) İşaretili olan ürünler stoklarla sınırlıdır.
Limited with stocks.

0450

Yıldız İki Ağız Anahtar (mm) Double Ended Ring Wrench (mm)



TS 3794
TS ISO 10104 Form B
DIN 838

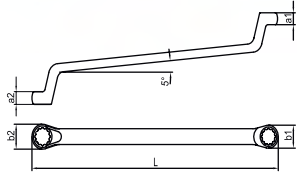

Krom vanadyum, Krom kaplı
Chrom vanadium, Chrom plated

| KOD CODE | mm | L mm | a1 mm | a2 mm | b1 mm | b2 mm | g | | TL/Ad. |
|--------------|-------|------|-------|-------|-------|-------|-----|----|--------|
| 0450 03 0607 | 6x7 | 140 | 4.8 | 5.2 | 11 | 12 | 45 | 10 | |
| 0450 03 0809 | 8x9 | 158 | 5.4 | 5.8 | 13.5 | 14.5 | 60 | 10 | |
| 0450 03 1011 | 10x11 | 175 | 6 | 6.4 | 16 | 17.5 | 90 | 10 | |
| 0450 03 1213 | 12x13 | 193 | 6.6 | 7.1 | 19 | 20 | 100 | 10 | |
| 0450 03 1415 | 14x15 | 210 | 7.7 | 8.1 | 21.5 | 23.5 | 140 | 10 | |
| 0450 03 1617 | 16x17 | 230 | 9.2 | 9.6 | 25.5 | 26.5 | 190 | 10 | |
| 0450 03 1819 | 18x19 | 246 | 10.2 | 10.6 | 27.5 | 29.5 | 240 | 10 | |
| 0450 03 2022 | 20x22 | 280 | 11.2 | 11.8 | 31 | 34 | 255 | 5 | |
| 0450 03 2123 | 21x23 | 284 | 11.4 | 12.2 | 32.5 | 35 | 300 | 5 | |
| 0450 03 2426 | 24x26 | 300 | 12.6 | 13.2 | 37 | 39 | 335 | 5 | |
| 0450 03 2528 | 25x28 | 314 | 13.6 | 14.2 | 38 | 42 | 430 | 5 | |
| 0450 03 2732 | 27x32 | 329 | 14.8 | 15.2 | 41 | 49 | 525 | 5 | |

0450

Yıldız İki Ağız Anahtar Takımı (mm) Double Ended Ring Wrench Set (mm)

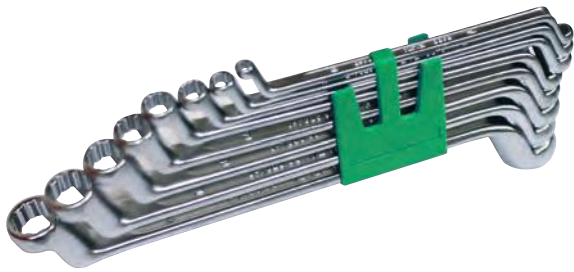

| KOD CODE | İÇERİK CONTENTS | g | | TL/Ad. |
|--------------|--|------|----|--------|
| 0450 00 2108 | 6x7 - 8x9 - 10x11 12x13 - 14x15 - 16x17 18x19 - 20x22 | 1120 | 8 | |
| 0450 00 2112 | 6x7 - 8x9 - 10x11 12x13 - 14x15 - 16x17 18x19 - 20x22 - 21x23 24x26 - 25x28 - 27x32 | 2710 | 12 | |

0601

Kurbağacık Anahtar Adjustable Wrench

TS 3796
DIN 3117

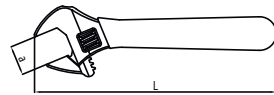

Krom vanadyum, Krom kaplı, PVC izoleli
Chrom vanadium, Chrom plated, PVC Insulated

| KOD CODE | L mm | L inch | a mm | g | | TL/Ad. |
|--------------|------|--------|------|-----|---|--------|
| 0601 01 0008 | 206 | 8" | 23 | 240 | 5 | |
| 0601 01 0010 | 256 | 10" | 28 | 400 | 5 | |
| 0601 01 0012 | 306 | 12" | 34 | 650 | 5 | |

1115

1/2" Altı Köşe Lokma Anahtar (mm) Socket Wrench 6 Points (mm)

TS ISO 2725
DIN 3124



1/2"

Krom vanadyum, Krom kaplı
Chrom vanadium, Chrom plated

| KOD CODE | mm | ø D1 mm | ø D2 mm | L mm | L1 mm | g | TL/Ad. |
|--------------|----|---------|---------|------|-------|-----|--------|
| 1115 06 0010 | 10 | 15.4 | 22 | 38 | 8 | 60 | 10 |
| 1115 06 0011 | 11 | 16.6 | 22 | 38 | 8 | 60 | 10 |
| 1115 06 0012 | 12 | 17.9 | 22 | 38 | 9 | 60 | 10 |
| 1115 06 0013 | 13 | 19 | 22 | 38 | 10 | 60 | 10 |
| 1115 06 0014 | 14 | 20.4 | 22 | 38 | 11 | 60 | 10 |
| 1115 06 0015 | 15 | 21.6 | 22 | 38 | 11 | 65 | 10 |
| 1115 06 0016 | 16 | 22.9 | 22 | 38 | 11 | 70 | 10 |
| 1115 06 0017 | 17 | 24.1 | 22 | 38 | 12 | 70 | 10 |
| 1115 06 0018 | 18 | 25.4 | 23 | 38 | 13 | 75 | 10 |
| 1115 06 0019 | 19 | 26.6 | 23 | 38 | 13 | 75 | 10 |
| 1115 06 0020 | 20 | 28 | 24 | 38 | 13 | 80 | 10 |
| 1115 06 0021 | 21 | 29.2 | 24 | 38 | 13 | 80 | 5 |
| 1115 06 0022 | 22 | 30.4 | 26 | 38 | 15 | 95 | 5 |
| 1115 06 0023 | 23 | 31.2 | 28 | 38 | 15 | 100 | 5 |
| 1115 06 0024 | 24 | 33 | 28 | 38 | 17 | 115 | 5 |
| 1115 06 0026 | 26 | 34 | 30 | 42 | 17 | 130 | 5 |
| 1115 06 0027 | 27 | 36.6 | 30 | 42 | 19 | 140 | 5 |
| 1115 06 0028 | 28 | 37.5 | 30 | 42 | 20 | 160 | 5 |
| 1115 06 0030 | 30 | 40 | 32 | 44 | 21 | 175 | 5 |
| 1115 06 0032 | 32 | 43 | 34 | 44 | 23 | 180 | 5 |

1514

1/2" T Kol Sliding T - Handle

TS ISO 3315
DIN 3122



1/2"

Krom vanadyum, Krom kaplı
Chrom vanadium, Chrom plated

| KOD CODE | L mm | g | TL/Ad. |
|--------------|------|-----|--------|
| 1514 06 4025 | 250 | 370 | 5 |

1514

1/2" T Kol Adaptörü Adapter



1/2"

Krom vanadyum, Krom kaplı
Chrom vanadium, Chrom plated

| KOD CODE | inch | g | TL/Ad. |
|--------------|-------------|----|--------|
| 1514 06 6250 | 3/8"Fx1/2"M | 90 | 5 |

1514

1/2" Ara Kol Extension Bar

TS ISO 3316
DIN 3123



1/2"

Krom vanadyum, Krom kaplı
Chrom vanadium, Chrom plated

| KOD CODE | L mm | g | TL/Ad. |
|--------------|------|-----|--------|
| 1514 06 4125 | 125 | 220 | 5 |
| 1514 06 4250 | 250 | 425 | 5 |

1514

1/2" Mafsal Universal Joint

TS ISO 3316
DIN 3123



1/2"

Krom vanadyum, Krom kaplı
Chrom vanadium, Chrom plated

| KOD CODE | L mm | g | TL/Ad. |
|--------------|------|-----|--------|
| 1514 06 4065 | 65 | 140 | 5 |

Havali aletler ile kullanmayınız / Do not use with power-tools

1514

1/2" Cırcır Kolu
Ratchet Handle



Krom vanadyum, Krom kaplı
Chrom vanadium, Chrom plated

1/2"

| KOD CODE | L mm | g | | TL/Ad. |
|--------------|------|-----|---|--------|
| 1514 06 5250 | 250 | 585 | 5 | |

1115

1/2" Altı Köşe Lokma Anahtar Takımı (17 Parça, mm)
Socket Wrench Set 6 Points (17 pcs, mm)



1/2"

| KOD CODE | LOKMALAR Sockets | AVADANLIKLAR Accessories | g | | TL/ Ad. |
|--------------|--|--|------|----|---------|
| 1115 00 2017 | 10 - 11 - 12 13 - 14 - 15 17 - 19 - 22 24 - 27 - 30 32 | 1/2" Cırcır Kolu Ratchet Handle 1/2" T Kol Adaptör Sliding T Handle Adapter 1/2" Mafsal Universal Joint 1/2" Ara Kol Extension Bar 250 mm | 2650 | 17 | |

1115

1/2" Altı Köşe Lokma Anahtar Takımı (24 Parça, mm)
Socket Wrench Set 6 Points (24 pcs, mm)



1/2"

| KOD CODE | LOKMALAR Sockets | AVADANLIKLAR Accessories | g | | TL/ Ad. |
|--------------|---|--|------|----|---------|
| 1115 00 2024 | 10 - 11 - 12 13 - 14 - 15 16 - 17 - 18 19 - 21 - 22 23 - 24 - 26 27 - 28 - 30 - 32 | 1/2" Cırcır Kolu Ratchet Handle 1/2" Mafsal Universal Joint 1/2" T Kol Adaptör Sliding T Handle Adapter 1/2" Ara Kol Extension Bar 125 mm 1/2" Ara Kol Extension Bar 250 mm | 3485 | 24 | |

Havali aletler ile kullanmayınız / Do not use with power-tools

2203

Maşalı Boru Anahtarı (85°)
Pipe Wrench (85°)

DIN 5234

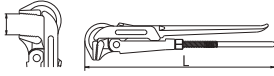

Krom vanadyum, Dişler induksiyonda sertleştirilmiş, Elektrostatik boyanmış
Chrom vanadium, Teeth induction hardened, Electrostatically painted

| KOD CODE | L mm | mm | inch | g | | TL/Ad. |
|---------------|------|----|--------|------|---|--------|
| 2203 10 0010 | 325 | 37 | 1" | 760 | 1 | |
| 2203 10 0015 | 430 | 43 | 1 1/2" | 1360 | 1 | |
| 2203 10 0020 | 585 | 49 | 2" | 2350 | 1 | |
| ★2203 10 0030 | 690 | 55 | 3" | 3200 | 1 | |

2401

Fort Pense
Waterpump Pliers

TS 60
TS ISO 8976
DIN 8976

2509

Ayarlı Pense
Grip

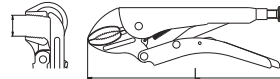
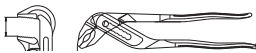

Krom vanadyum, Nikel kaplı, PVC izoleli
Chrom vanadium, Nickel plated, PVC Insulated

Çeneler krom vanadyum çeliğinden dövülmüştür, Nikel kaplama,
Kullanım sahası: Yuvarlak ve düz malzemeler
Jaws Chrom vanadium forged, Nickel plated
Application field : Flat and round materials

| KOD CODE | L mm | L inch | mm | g | | TL/Ad. |
|--------------|------|--------|----|-----|---|--------|
| 2401 11 0240 | 240 | 9 1/2" | 35 | 375 | 5 | |

| KOD CODE | L mm | L inch | mm | g | | TL/Ad. |
|--------------|------|--------|----|-----|---|--------|
| 2509 11 0225 | 225 | 9" | 30 | 470 | 5 | |

3021

Kombine Pense Opak Seri Combination Pliers

TS 60
DIN ISO 5746



Özel alaşımli çelik, Kesici ağızlar induksiyonda sertleştirilmiş, PVC saplı
Special steel, Cutters induction hardened, PVC handle

| KOD CODE | L mm | L inch | g | | TL/Ad. |
|--------------|------|--------|-----|---|--------|
| 3021 12 1160 | 160 | 6 1/4" | 200 | 5 | |
| 3021 12 1180 | 180 | 7 1/8" | 250 | 5 | |
| 3021 12 1200 | 200 | 8" | 310 | 5 | |

3221

Kargaburun Düz Uçlu Opak Seri Long Nose Pliers (Flat)

TS 60
TS ISO 5745



Özel alaşımli çelik, Kesici ağızlar induksiyonda sertleştirilmiş, PVC saplı
Special steel, Cutters induction hardened, PVC handle

| KOD CODE | L mm | L inch | g | | TL/Ad. |
|--------------|------|--------|-----|---|--------|
| 3221 13 1160 | 160 | 6 1/4" | 145 | 5 | |
| 3221 13 1200 | 200 | 8" | 190 | 5 | |

3701

Yan Keski Opak Seri Side Cutting Pliers

TS 60
TS ISO 5749
DIN 5749



Özel alaşımli çelik, Kesici ağızlar induksiyonda sertleştirilmiş, PVC saplı
Special steel, Cutters induction hardened, PVC handle

| KOD CODE | L mm | L inch | g | | TL/Ad. |
|--------------|------|--------|-----|---|--------|
| 3701 16 1140 | 140 | 5 1/2" | 160 | 5 | |
| 3701 16 1160 | 160 | 6 1/4" | 220 | 5 | |

3801

Kerpeten Carpenter Pincers

TS 60
TS ISO 9243
DIN ISO 9243



Özel alaşımli çelik, Kesici ağızlar induksiyonda sertleştirilmiş, Vernikli, PVC izoleli
Special steel, Cutters induction hardened, Lacquered, PVC Insulated

| KOD CODE | L mm | L inch | g | | TL/Ad. |
|--------------|------|--------|-----|---|--------|
| 3801 15 0160 | 160 | 6 1/4" | 235 | 5 | |
| 3801 15 0180 | 180 | 7 1/8" | 245 | 5 | |
| 3801 15 0200 | 200 | 8" | 390 | 5 | |

3832

Betoncu Kerpeteni Tower Pincers

TS 60
TS ISO 9242
DIN ISO 9242



Özel alaşımli çelik, Kesici ağızlar induksiyonda sertleştirilmiş, Vernikli, PVC izoleli
Special steel, Cutters induction hardened, Lacquered, PVC insulated

| KOD CODE | L mm | L inch | g | | TL/Ad. |
|--------------|------|--------|-----|---|--------|
| 3832 15 0225 | 225 | 9" | 335 | 5 | |
| 3832 15 0250 | 250 | 10" | 415 | 5 | |
| 3832 15 0280 | 280 | 11" | 475 | 5 | |

4170

Değişken Uçlu Tornavida Screwdriver - Reversible

TSEK



Krom vanadyum, Krom kaplı, PP saplı
Chrom vanadium, Chrom plated, PP handle

| KOD CODE | σDxL1 mm | axb mm | + | L mm | g | | TL/Ad. |
|--------------|----------|--------|-----|------|----|----|--------|
| 4170 17 0680 | 6x80 | 1.2x6 | Ph2 | 180 | 60 | 10 | |

4150

Opak Seri Düz Uçlu Tornavida Screwdriver, Opak, Flat

TS ISO 2380 - 1
DIN ISO 2380-1

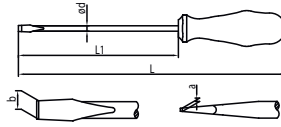

Krom vanadyum, Krom kaplı, PP saplı
Chrom vanadium, Chrom plated, PP handle

| KOD CODE | øDxL1 mm | - | | L mm | g | □ | TL/Ad. |
|--------------|-------------|---------|---------|---------|-----|----|--------|
| | | a mm | b mm | | | | |
| 4150 17 0380 | 3x80 | 0.5 | 3 | 150 | 20 | 10 | |
| 4150 17 0480 | 4x80 | 0.8 | 4 | 170 | 30 | 10 | |
| 4150 17 4100 | 4x100 | 0.8 | 4 | 190 | 40 | 10 | |
| 4150 17 5100 | 5x100 | 1.0 | 5.5 | 200 | 55 | 10 | |
| 4150 17 5125 | 5x125 | 1.0 | 5.5 | 225 | 60 | 10 | |
| 4150 17 6100 | 6x100 | 1.2 | 6.5 | 200 | 70 | 10 | |
| 4150 17 6125 | 6x125 | 1.2 | 6.5 | 225 | 75 | 10 | |
| 4150 17 6150 | 6x150 | 1.2 | 6.5 | 250 | 80 | 10 | |
| 4150 17 7150 | 7x150 | 1.2 | 8 | 260 | 110 | 10 | |
| 4150 17 8150 | 8x150 | 1.6 | 10 | 260 | 130 | 10 | |
| 4150 17 8175 | 8x175 | 1.6 | 10 | 285 | 135 | 10 | |

4170

Opak Seri Yıldız Uçlu Tornavida Screwdriver, Opak Phillips

TS 59 - 5 ISO 8764
DIN ISO 8764

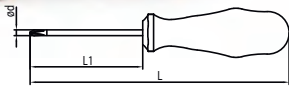
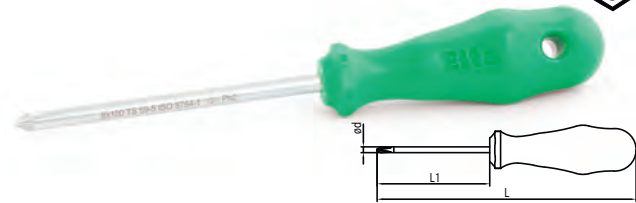

Krom vanadyum, Krom kaplı, PP saplı
Chrom vanadium, Chrom plated, PP handle

| KOD CODE | øDxL1 mm | + | L mm | g | □ | TL/Ad. |
|--------------|-------------|-----|---------|-----|----|--------|
| | | | | | | |
| 4170 18 4580 | 4.5x80 | Ph1 | 170 | 45 | 10 | |
| 4170 18 6100 | 6x100 | Ph2 | 200 | 70 | 10 | |
| 4170 18 8150 | 8x150 | Ph3 | 260 | 130 | 10 | |

4150

Opak Seri Tornavida Seti (6 parça) Screwdriver Set, Opak (6 Pcs)



| KOD CODE | İÇERİK CONTENTS | g | □ | TL/Ad. |
|--------------|------------------------|-----|---|--------|
| 4150 00 8106 | 4x80 - 5x100 - 6x125 | 545 | 6 | |
| | 7x150 | | | |
| | Düz uçlu / Flat | | | |
| | 4.5x80 - 6x100 | | | |
| | Yıldız uçlu / Phillips | | | |

4150

Opak Seri Tornavida Seti (7 parça) Screwdriver Set, Opak (7 Pcs)



| KOD CODE | İÇERİK CONTENTS | g | □ | TL/Ad. |
|--------------|------------------------|-----|---|--------|
| 4150 00 8107 | 3x80 - 4x100 - 5x125 | 605 | 7 | |
| | 6x150 - 8x175 | | | |
| | Düz uçlu / Flat | | | |
| | 4.5x80 - 6x100 | | | |
| | Yıldız uçlu / Phillips | | | |

(*) İşaretili olan ürünler stoklarla sınırlıdır.
Limited with stocks.

4908

Allen Anahtar Altı Köşe (mm) Hex Key Wrench (mm)

TS ISO 2936
DIN ISO 2936



Krom vanadyum, Siyah Oksit Kaplı
Chrom vanadium, Black finish

| KOD CODE | mm | L mm | L1 mm | g | TL/Ad. |
|--------------|-----|------|-------|-----|--------|
| 4908 22 0015 | 1.5 | 45 | 14 | 1.5 | 10 |
| 4908 22 0020 | 2 | 50 | 16 | 2 | 10 |
| 4908 22 0025 | 2.5 | 56 | 18 | 4 | 10 |
| 4908 22 0030 | 3 | 63 | 20 | 6 | 10 |
| 4908 22 0035 | 3.5 | 66 | 22 | 8 | 10 |
| 4908 22 0040 | 4 | 70 | 25 | 10 | 10 |
| 4908 22 0050 | 5 | 80 | 28 | 20 | 10 |
| 4908 22 0060 | 6 | 90 | 32 | 30 | 10 |
| 4908 22 0070 | 7 | 95 | 36 | 40 | 10 |
| 4908 22 0080 | 8 | 100 | 36 | 55 | 10 |
| 4908 22 0090 | 9 | 105 | 38 | 75 | 10 |
| 4908 22 0100 | 10 | 112 | 40 | 100 | 10 |
| 4908 22 0120 | 12 | 125 | 45 | 160 | 10 |

4908

Allen Anahtar Takım Altı Köşe (mm) Hex Key Wrench Set (mm)

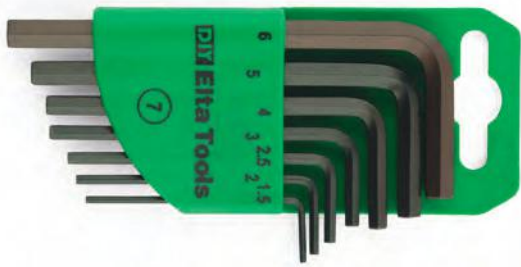

| KOD CODE | İÇERİK CONTENTS | g | TL/Ad. |
|--------------|--|-----|--------|
| 4908 00 3107 | 1.5 - 2 - 2.5 - 3 - 4 - 5 - 6 | 80 | 7 |
| 4908 00 3109 | 1.5 - 2 - 2.5 - 3 - 4 5 - 6 - 8 - 10 | 235 | 9 |
| 4908 00 3110 | 1.5 - 2 - 2.5 - 3 - 4 - 5 6 - 8 - 10 - 12 | 395 | 10 |

4922

T Tipi Allen Anahtar (mm) Hex Key Wrench T - Handle (mm)

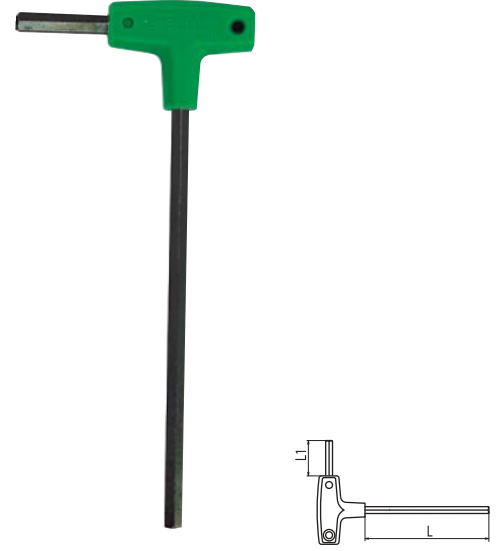

Krom vanadyum, Siyah Oksit Kaplı, PP saplı
Chrom vanadium, Black finish, PP handle

| KOD CODE | mm | L mm | L1 mm | g | TL/Ad. |
|--------------|-----|------|-------|-----|--------|
| 4922 22 0025 | 2.5 | 110 | 14 | 15 | 5 |
| 4922 22 0030 | 3 | 125 | 18 | 20 | 5 |
| 4922 22 0040 | 4 | 140 | 22 | 30 | 5 |
| 4922 22 0050 | 5 | 155 | 26 | 55 | 5 |
| 4922 22 0060 | 6 | 170 | 30 | 75 | 5 |
| 4922 22 0070 | 7 | 185 | 34 | 115 | 5 |
| 4922 22 0080 | 8 | 200 | 38 | 150 | 5 |
| 4922 22 0100 | 10 | 220 | 48 | 270 | 5 |

4922

T Tipi Allen Anahtar Takımı (8 Parça, mm) Hex Key Wrench T - Handle Set (8 Pcs, mm)



| KOD CODE | İÇERİK CONTENTS | g | TL/Ad. |
|--------------|-----------------------------------|-----|--------|
| 4922 00 8108 | 2.5 - 3 - 4 - 5 6 - 7 - 8 - 10 | 730 | 8 |

(*) İşaretili olan ürünler stoklarla sınırlıdır.
Limited with stocks.

4915

Kaset Allen Anahtar Takımı (6 Parça, mm)
Hex Key Wrench Folding Set (6 Pcs, mm)



Krom vanadyum, Siyah oksid kaplı
Chrom vanadium, Black finish

| KOD CODE | İÇERİK CONTENTS | g | TL/Ad. |
|--------------|-------------------------|-----|--------|
| 4915 00 6106 | 2.5 - 3 - 4 - 5 - 6 - 8 | 175 | 1 |

5011

Iskarpela (Düz)
Wood Chisel

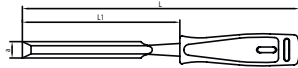

Özel alaşımlı çelik, Uç indüksiyonda sertleştirilmiş, PP Saplı
Special steel, induction hardened tips, PP Handle

| KOD CODE | a mm | L mm | L1 mm | g | TL/Ad. |
|--------------|------|------|-------|-----|--------|
| 5011 23 0006 | 6 | 245 | 120 | 105 | 5 |
| 5011 23 0008 | 8 | 245 | 122 | 125 | 5 |
| 5011 23 0010 | 10 | 245 | 124 | 140 | 5 |
| 5011 23 0012 | 12 | 245 | 126 | 140 | 5 |
| 5011 23 0014 | 14 | 245 | 128 | 145 | 5 |
| 5011 23 0016 | 16 | 255 | 130 | 165 | 5 |
| 5011 23 0018 | 18 | 255 | 132 | 165 | 5 |
| 5011 23 0020 | 20 | 255 | 134 | 165 | 5 |
| 5011 23 0022 | 22 | 255 | 136 | 180 | 5 |
| 5011 23 0024 | 24 | 255 | 138 | 205 | 5 |
| 5011 23 0026 | 26 | 255 | 140 | 205 | 5 |
| 5011 23 0030 | 30 | 260 | 150 | 205 | 5 |

5884

Plastik Şerit Metre
Plastic Measuring tapes



| KOD CODE | ÖLÇÜ SIZE | g | TL/Ad. |
|--------------|-----------|-----|--------|
| 5884 26 0003 | 3 | 95 | 5 |
| 5884 26 0005 | 5 | 195 | 5 |

5891

Testere Kolu
Hacksaw Frame

DIN 6473



| KOD CODE | L mm | g | TL/Ad. |
|--------------|------|-----|--------|
| 5891 26 0830 | 300 | 345 | 5 |

6351

Levye Oluklu
Tyre Lever, Straight

TSEK



Krom vanadyum, Krom kaplı
Chrom vanadium, Chrom plated

| KOD CODE | L mm | L inch | g | TL/Ad. |
|--------------|------|--------|-----|--------|
| 6351 26 0400 | 400 | 16" | 435 | 5 |
| 6351 26 0500 | 500 | 20" | 680 | 5 |
| 6351 26 0600 | 600 | 24" | 970 | 5 |

6730

Çim Kesme Makası (Düz Ağız)
Grass Shears (Straight)



| KOD CODE | L mm | L inch | g | TL/Ad. |
|--------------|------|---------|-----|--------|
| 6730 27 0550 | 550 | 21 5/8" | 915 | 5 |

6722

Bağ Makası (Hafif Tip)
Pruning Shears (Light)



Alüminyum gövde, Daldırma PVC izoleli
Aluminum forged body, PVC dipped

| KOD CODE | L mm | L inch | g | TL/Ad. |
|--------------|------|--------|-----|--------|
| 6722 27 0220 | 220 | 8 5/8" | 240 | 5 |

6731

Çim Kesme Makası (Eğri Ağız)
Grass Shears (Wave Edges)



| KOD CODE | L mm | L inch | g | TL/Ad. |
|--------------|------|---------|------|--------|
| 6731 27 0650 | 650 | 25 5/8" | 1195 | 5 |

8011

Teşhir Panosu
Display



6721

Bağ Makası (Lüks)
Pruning Shears (Lux)



Özel alaşımlı çelik, Kesici ağızlar indüksiyonda sertleştirilmiş, PVC izoleli
Special steel, Cutters induction hardened, PVC dipped

| KOD CODE | L mm | L inch | g | TL/Ad. |
|--------------|------|--------|-----|--------|
| 6721 27 0205 | 205 | 8" | 290 | 5 |

| KOD CODE | SIZE mm | Cinsi | g | TL/Ad. |
|--------------|---------------|-------|-------|--------|
| 8011 31 6001 | 500x1000x2250 | Boş | 14000 | 1 |

IZELTAS®

YEDEK PARÇALAR

SPARE PARTS

Yedek Parçalar
Spare Parts



Kurbağacık Anahtar ve Ayarlı Montaj Anahtarı Yedek Parçaları
Adjustable Wrench, Spare Parts

| | KOD CODE | L mm | L inch | g | TL/Ad. |
|-----------------------------|--------------|------|--------|----|--------|
| Somun <i>Nut</i> | 0600 01 0206 | 160 | 6" | 5 | 10 |
| | 0600 01 0208 | 208 | 8" | 10 | 10 |
| | 0600 01 0210 | 260 | 10" | 10 | 10 |
| | 0600 01 0212 | 308 | 12" | 20 | 10 |
| | 0600 01 0215 | 388 | 15" | 65 | 10 |
| Vida <i>Bolt</i> | 0600 01 0306 | 160 | 6" | 3 | 10 |
| | 0600 01 0308 | 208 | 8" | 5 | 10 |
| | 0600 01 0310 | 260 | 10" | 5 | 10 |
| | 0600 01 0312 | 308 | 12" | 10 | 10 |
| | 0600 01 0315 | 388 | 15" | 20 | 10 |
| Yay <i>Spring</i> | 0600 01 0406 | 160 | 6" | 1 | 10 |
| | 0600 01 0408 | 208 | 8" | 1 | 10 |
| | 0600 01 0410 | 260 | 10" | 1 | 10 |
| | 0600 01 0412 | 308 | 12" | 1 | 10 |
| | 0600 01 0415 | 388 | 15" | 3 | 10 |

2100
Stilson Anahtar Yedek Parçaları
Stilson Wrench Spare Part

| | KOD CODE | ÖLÇÜ FOR | g | TL/Ad. |
|----------------------------|---|--------------|-----|--------|
| Çene <i>Jaw</i> | 2100 10 0108 | 8" | 80 | 5 |
| | 2100 10 0110 | 10" | 180 | 5 |
| | 2100 10 0112 | 12" | 320 | 5 |
| | 2100 10 0114 | 14" | 400 | 5 |
| | 2100 10 0118 | 18" | 575 | 5 |
| | 2100 10 0124 | 24" | 980 | 5 |
| | Bağlantı Parçası <i>Connection Part</i> | 2100 10 0208 | 8" | 60 |
| 2100 10 0210 | | 10" | 95 | 5 |
| 2100 10 0212 | | 12" | 100 | 5 |
| 2100 10 0214 | | 14" | 195 | 5 |
| 2100 10 0218 | | 18" | 345 | 5 |
| 2100 10 0224 | | 24" | 445 | 5 |
| Somun <i>Nut</i> | | 2100 10 0308 | 8" | 10 |
| | 2100 10 0310 | 10" | 30 | 5 |
| | 2100 10 0312 | 12" | 25 | 5 |
| | 2100 10 0314 | 14" | 45 | 5 |
| | 2100 10 0318 | 18" | 75 | 5 |
| | 2100 10 0324 | 24" | 105 | 5 |

2110
Ağır Tip Boru Anahtarı Yedek Parçaları
Pipe Wrench, Heavy Duty Spare Parts

| | KOD CODE | ÖLÇÜ FOR | g | TL/Ad. | |
|---------------------------|----------------------------|--------------|------|--------|---|
| Çene <i>Jaw</i> | 2110 10 0108 | 8" | 100 | 5 | |
| | 2110 10 0110 | 10" | 205 | 5 | |
| | 2110 10 0112 | 12" | 235 | 5 | |
| | 2110 10 0114 | 14" | 400 | 5 | |
| | 2110 10 0118 | 18" | 675 | 5 | |
| | 2110 10 0124 | 24" | 900 | 5 | |
| | 2110 10 0136 | 36" | 1820 | 5 | |
| | 2110 10 0148 | 48" | 3410 | 5 | |
| | Somun <i>Nut</i> | 2110 10 0308 | 8" | 10 | 5 |
| | | 2110 10 0310 | 10" | 25 | 5 |
| 2110 10 0312 | | 12" | 35 | 5 | |
| 2110 10 0314 | | 14" | 40 | 5 | |
| 2110 10 0318 | | 18" | 65 | 5 | |
| 2110 10 0324 | | 24" | 115 | 5 | |
| 2110 10 0336 | | 36" | 230 | 5 | |
| 2110 10 0348 | | 48" | 305 | 5 | |

Alt Çene ve Pim
Lower Jaw and Pin

| | | | |
|--------------|-----|-----|---|
| 2110 10 0408 | 8" | 15 | 5 |
| 2110 10 0410 | 10" | 40 | 5 |
| 2110 10 0412 | 12" | 60 | 5 |
| 2110 10 0414 | 14" | 60 | 5 |
| 2110 10 0418 | 18" | 90 | 5 |
| 2110 10 0424 | 24" | 125 | 5 |
| 2110 10 0436 | 36" | 225 | 5 |
| 2110 10 0448 | 48" | 285 | 5 |

2201
Maşalı Boru Anahtarı Yedek Somun
Nut

| | KOD CODE | ÖLÇÜ FOR | g | TL/Ad. |
|--------------|----------|----------|----|--------|
| 2201 10 0110 | 1" | 25 | 10 | |
| 2201 10 0115 | 1 1/2" | 40 | 10 | |
| 2201 10 0120 | 2" | 60 | 10 | |
| 2201 10 0130 | 3" | 75 | 10 | |
| 2201 10 0140 | 4" | 75 | 10 | |

2350
Demir Kesme Makası Yedek
Bolt Cutters Spare Part
Çene
Jaw

| | KOD CODE | ÖLÇÜ SIZE | KAPASİTE CAPACITY Ø mm | g | TL/Ad. |
|--------------|----------|-----------|---------------------------|---|--------|
| 2350 27 0118 | 18" | 6 - 8 | 850 | 1 | |
| 2350 27 0124 | 24" | 8 - 10 | 870 | 1 | |
| 2350 27 0130 | 30" | 9 - 13 | 1250 | 1 | |
| 2350 27 0136 | 36" | 11 - 16 | 1850 | 1 | |

(★) İşaretili olan ürünler stoklarla sınırlıdır.
Limited with stocks.

5850

Plastik Çekiç Yedek Başlık Plastic Hammer Spare Head



| KOD CODE | ØD mm | g | TL/Ad. |
|--------------|----------|-----|--------|
| 5850 25 0130 | 30 | 35 | 10 |
| 5850 25 0140 | 40 | 70 | 10 |
| 5850 25 0150 | 50 | 120 | 10 |

6400

Keser Yedek Sapı / Adze Handle



| KOD CODE | L mm | g | TL/Ad. |
|--------------|---------|-----|--------|
| 6400 25 0001 | 400 | 140 | 10 |

5800

Tesviyeci Çekiç Yedek Sapı (Kamalı) Hammer Handle (With Pin)



| KOD CODE | L mm | g | g | TL/Ad. |
|--------------|---------|------|-----|--------|
| 5800 25 0001 | 260 | 100 | 60 | 10 |
| 5800 25 0002 | 280 | 200 | 60 | 10 |
| 5800 25 0003 | 300 | 300 | 95 | 10 |
| 5800 25 0005 | 320 | 500 | 100 | 10 |
| 5800 25 0010 | 360 | 1000 | 165 | 10 |
| 5800 25 0015 | 380 | 1500 | 185 | 10 |
| 5800 25 0020 | 400 | 2000 | 205 | 10 |

5865

Madırğa Yedek Sap (Kamalı) Mallet Handle (With Pin)



| KOD CODE | L mm | g | TL/Ad. |
|--------------|---------|------|--------|
| 5865 25 0001 | 260 | 1000 | 10 |
| 5865 25 0002 | 280 | 1500 | 10 |

6410

Nacak Yedek Sap (Kamalı) Hatchet Handle (With Pin)



| KOD CODE | L mm | g | g | TL/Ad. |
|--------------|---------|-----|-----|--------|
| 6410 25 0001 | 380 | 800 | 250 | 10 |

03755

Kablo Sıyırıcı Yedek Bıçağı Cable Strippers Spare Blade



| KOD CODE | ÖLÇÜ SIZE | g | TL/Ad. |
|--------------|-------------------------|----|--------|
| 03755 50 625 | Tek 6/300 Çok 1,5/25 | 25 | 5 |

06375

Ayarlı Yağ Filtresi Sökeceği Yedek Kelepçe Adjustable Slot Type Oil Filter Wrench Spare Clamp



| KOD CODE | Ø mm | g | TL/Ad. |
|--------------|---------|----|--------|
| 06375 50 010 | 65-110 | 20 | 5 |

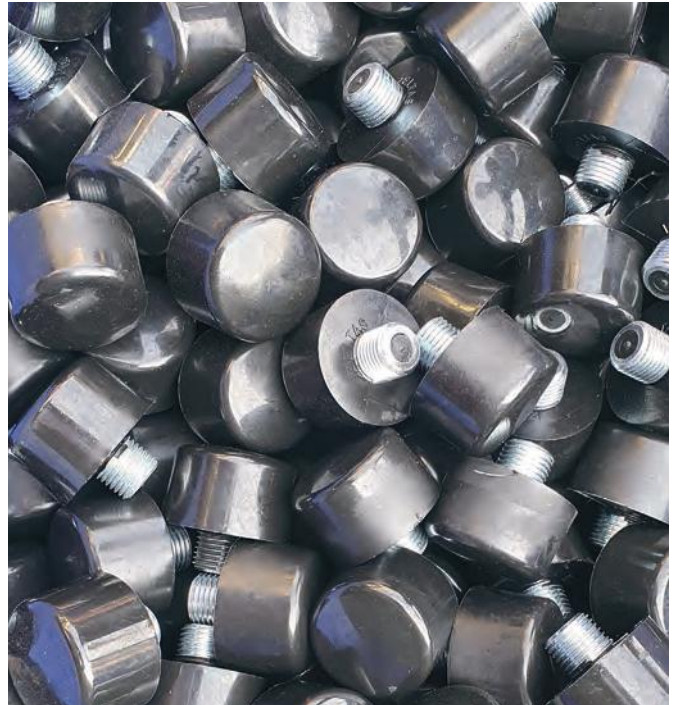

6230

Gres Pompası Yedek Ucu
Grease Gun Nozzle



500cc
300cc

| KOD CODE | L mm | Ø mm | g | TL/Ad. |
|--------------|------|------|----|--------|
| 6230 26 2500 | 38 | 15 | 31 | 10 |

Hortumu

Hose for
Grease Gun



| KOD CODE | Ø mm | L mm | g | TL/Ad. |
|--------------|------|------|-----|--------|
| 6230 26 3300 | 8 | 300 | 34 | 10 |
| 6230 26 3500 | 12 | 500 | 102 | 10 |

05898

HSS Testere Laması
Hacksaw Blade HSS



| KOD CODE | ÖLÇÜ SIZE | g | TL/Ad. |
|--------------|------------|----|--------|
| 05898 50 283 | 13x0.65x18 | 20 | 100 |

05899

Bimetal Testere Laması
Hacksaw Blade Bimetal



| KOD CODE | ÖLÇÜ SIZE | g | TL/Ad. |
|--------------|------------|----|--------|
| 05899 50 283 | 13x0.65x18 | 20 | 100 |

6735

Dal Budama Testeresi Yedek Bıçak
Spare Blade for Pruning Saw



| KOD CODE | L mm | g | TL/Ad. |
|--------------|------|----|--------|
| 6735 27 1300 | 300 | 60 | 5 |

06765

Plastik Boru Kesme Makası Bıçağı
Plastic Pipe Cutter Spare Blade



| KOD CODE | ÖLÇÜ SIZE | g | TL/Ad. |
|--------------|-----------|-----|--------|
| 06765 50 042 | 42 | 73 | 5 |
| 06765 50 063 | 63 | 105 | 5 |

6850

Mini Boru Kesici Bıçağı / Blade For Mini Tube Cutter
Standart Boru Kesici Bıçağı / Blade For Standard Tube Cutter
Teleskopik Boru Kesici Bıçağı / Blade For Telescopic Tube Cutter



| KOD CODE | ÖLÇÜ SIZE | g | TL/Ad. |
|--------------|---------------|---|--------|
| 6850 28 1322 | 1/4" - 1 3/8" | 5 | 10 |

6865

Profesyonel Boru Kesici Bıçağı
Blade For Professional Tube Cutter



| KOD CODE | ÖLÇÜ SIZE | g | TL/Ad. |
|--------------|-----------|----|--------|
| 6865 28 0150 | 1/8" - 2" | 30 | 5 |



7010-7020

Standart Çektirme Yedek Parçaları Spare Parts For Standard Pullers

Uzatma Parçası / Connection Part, Extention



| KOD CODE | L mm | KULLANILAN ÇEKTİRME FOR | g | TL/Ad. |
|--------------|------|--------------------------------|------|--------|
| 7010 29 2033 | 200 | 8x10 - 12x10 | 415 | 1 |
| 7010 29 3033 | 300 | 16x15 - 20x15 | 890 | 1 |
| 7010 29 4033 | 400 | 25x20 - 35x20 37x20 - 52x20 | 2350 | 1 |

Kol / Arm



| KOD CODE | KULLANILAN ÇEKTİRME FOR | g | TL/Ad. |
|--------------|--------------------------------|-----|--------|
| 7010 29 0822 | 8x10 - 12x10 | 110 | 1 |
| 7010 29 1622 | 16x15 - 20x15 | 330 | 1 |
| 7010 29 2522 | 25x20 - 35x20 52x20 - 37x20 | 775 | 1 |

Bağlantı Parçası / Connection Part



| KOD CODE | KULLANILAN ÇEKTİRME FOR | g | TL/Ad. |
|--------------|--------------------------------|-----|--------|
| 7010 29 0833 | 8x10 - 12x10 | 160 | 1 |
| 7010 29 1633 | 16x15 - 20x15 | 325 | 1 |
| 7010 29 2533 | 25x20 - 35x20 52x20 - 37x20 | 930 | 1 |

Mil / Spindle



| KOD CODE | KULLANILAN ÇEKTİRME FOR | g | TL/Ad. |
|--------------|-------------------------|------|--------|
| 7010 29 0844 | 8x10 - 12x10 | 185 | 1 |
| 7010 29 1644 | 16x15 - 20x15 | 555 | 1 |
| 7010 29 2544 | 25x20 | 1400 | 1 |
| 7010 29 3544 | 35x20 - 37x20 | 2185 | 1 |
| 7010 29 5244 | 52x20 | 3210 | 1 |

7030-7040

Master Çektirme Yedek Parçaları/Spare Parts For Master Puller

Kol / Arm



| KOD CODE | KULLANILAN ÇEKTİRME FOR | g | TL/Ad. |
|--------------|-------------------------|-----|--------|
| 7030 29 0822 | 8x8 | 110 | 1 |
| 7030 29 1222 | 12x12 | 215 | 1 |
| 7030 29 1622 | 16x16 | 345 | 1 |
| 7030 29 2322 | 23x20 | 580 | 1 |

Mil/Spindle



| KOD CODE | KULLANILAN ÇEKTİRME FOR | g | TL/Ad. |
|--------------|-------------------------|------|--------|
| 7030 29 0844 | 8x8 | 180 | 1 |
| 7030 29 1244 | 12x12 | 360 | 1 |
| 7030 29 1644 | 16x16 | 680 | 1 |
| 7030 29 2344 | 23x20 | 1230 | 1 |

7050-7060

Batarya Çektirme Yedek Parçaları Spare Parts For Battery Pullers

Kol / Arm



| KOD CODE | KULLANILAN ÇEKTİRME FOR | g | TL/Ad. |
|--------------|-------------------------|-----|--------|
| 7050 29 0422 | 6x4 | 40 | 1 |
| 7050 29 0622 | 6x6 | 50 | 1 |
| 7050 29 0822 | 8x8 | 110 | 1 |

Mil / Spindle



| KOD CODE | KULLANILAN ÇEKTİRME FOR | g | TL/Ad. |
|--------------|-------------------------|-----|--------|
| 7050 29 0444 | 6x4 | 95 | 1 |
| 7050 29 0644 | 6x6 | 105 | 1 |
| 7050 29 0844 | 8x8 | 200 | 1 |

7070-7080

S Tipi Çektirme Yedek Parçaları Spare Parts For S Type Puller

Kol / Arm



| KOD CODE | KULLANILAN ÇEKTİRME FOR | g | TL/Ad. |
|--------------|-------------------------|-----|--------|
| 7070 29 2022 | 20x13 | 405 | 1 |

Mil / Spindle



| KOD CODE | KULLANILAN ÇEKTİRME FOR | g | TL/Ad. |
|--------------|-------------------------|-----|--------|
| 7070 29 2044 | 20x13 | 520 | 1 |

7090-7100

Üniversal Çektirme Yedek Parçaları Spare Parts For Universal Puller

Kol / Arm



| KOD CODE | KULLANILAN ÇEKTİRME FOR | g | TL/Ad. |
|--------------|-------------------------|-----|--------|
| 7090 29 2322 | 22x22 | 690 | 1 |

Mil / Spindle



| KOD CODE | KULLANILAN ÇEKTİRME FOR | g | TL/Ad. |
|--------------|-------------------------|-----|--------|
| 7090 29 2244 | 22x22 | 565 | 1 |



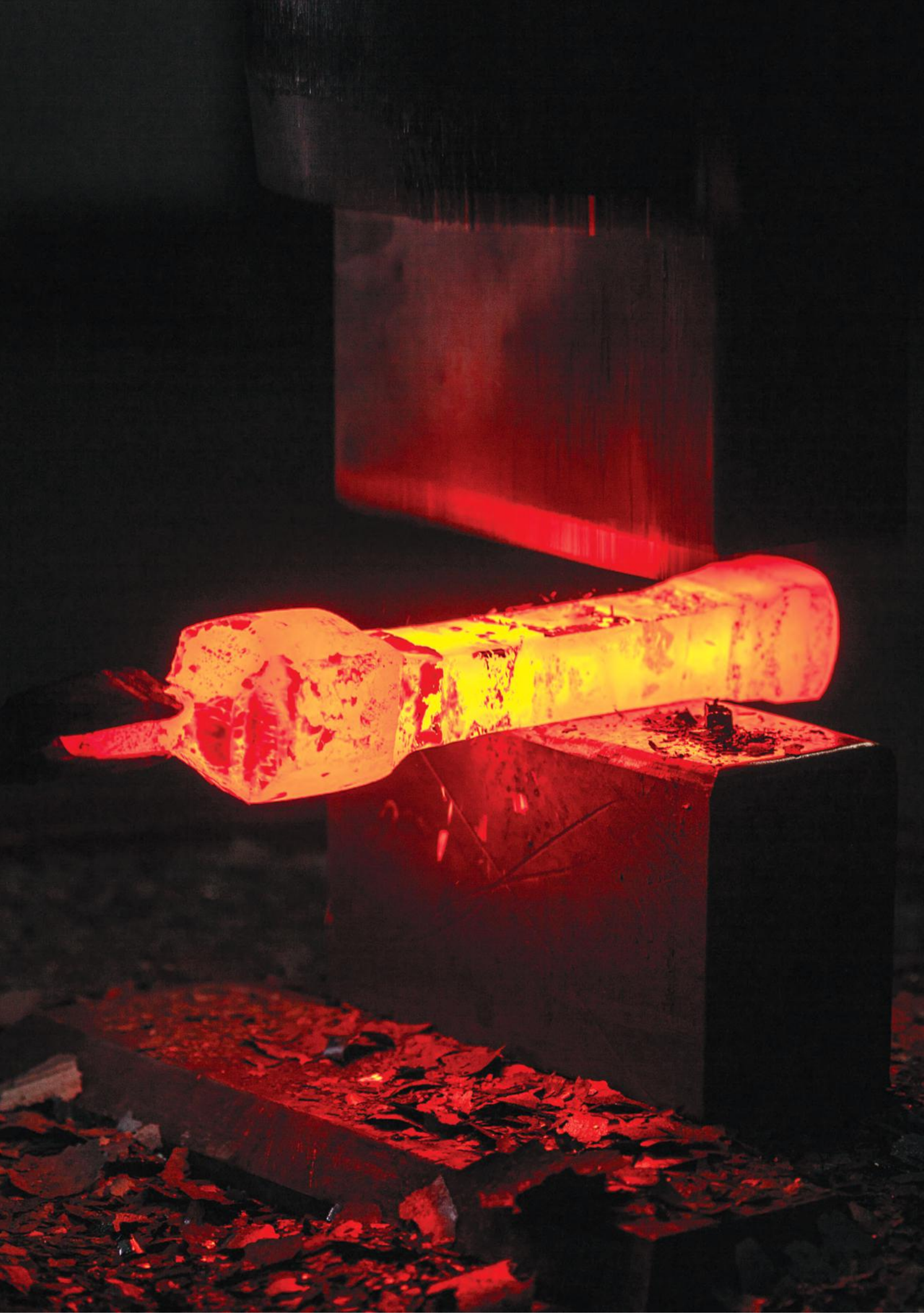

IZELTAS®

TİCARİ TEŞHİR ÜRÜNLERİ

COMMERCIAL DISPLAY PRODUCTS

Ticari Teşhir Ürünleri
Commercial Display Products

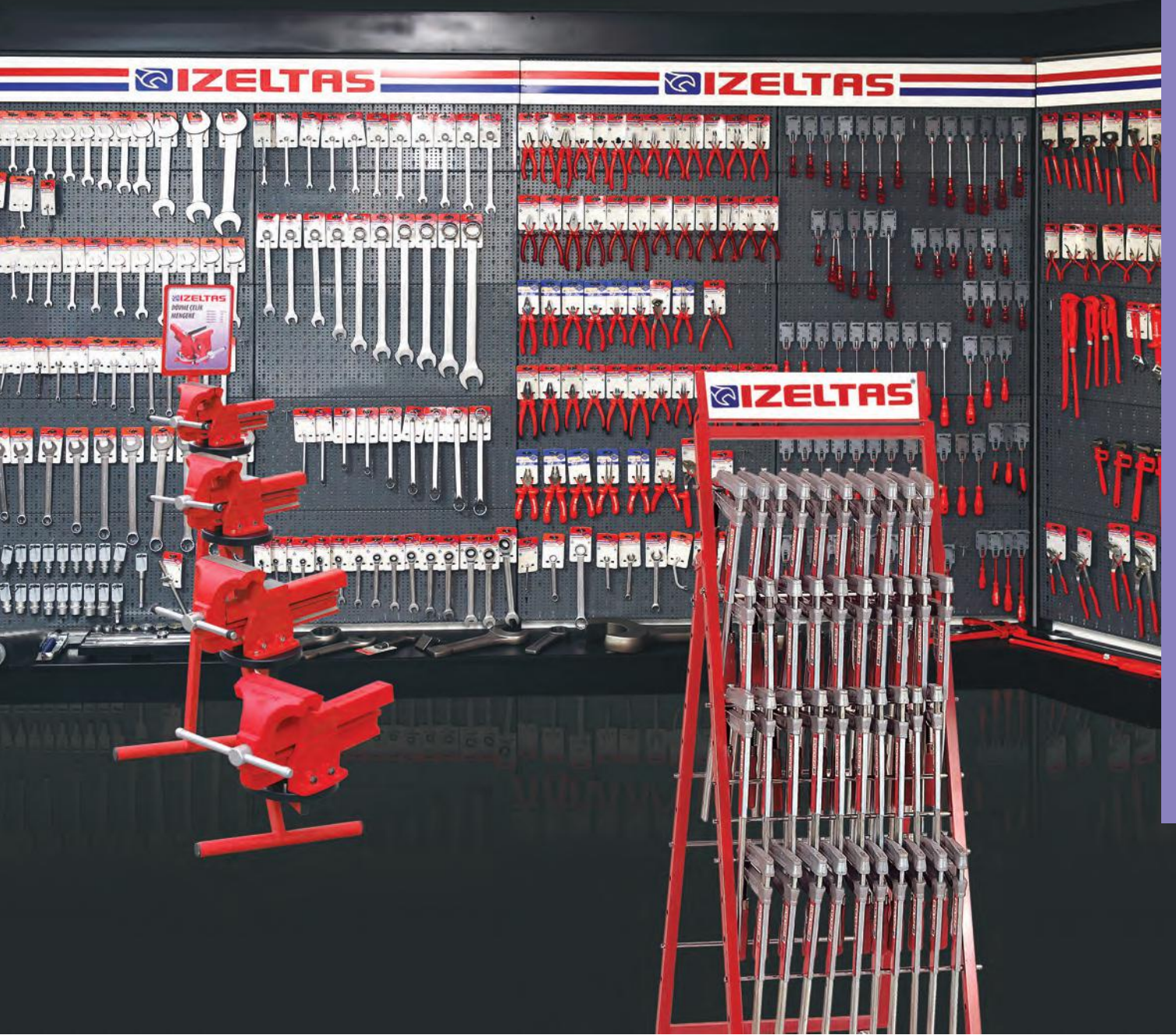

1113

1/2" Lokma Anahtar Sehpası
Display Frame for Sockets

**1/2"**

| KOD CODE | ÖLÇÜ SIZE mm | g | TL/Ad. |
|--------------|--------------|------|--------|
| 1113 31 6100 | 175x360x605 | 5800 | 1 |

7010

Çektirme Sehpası
Display Frame For Pullers



| KOD CODE | İÇERİK CONTENTS | g | TL/Ad. |
|--------------|-----------------|------|--------|
| 7010 31 6105 | Boş - Empty | 2000 | 1 |

2350

Demir Kesme Makası Sehpası
Display Frame for Bolt Cutters

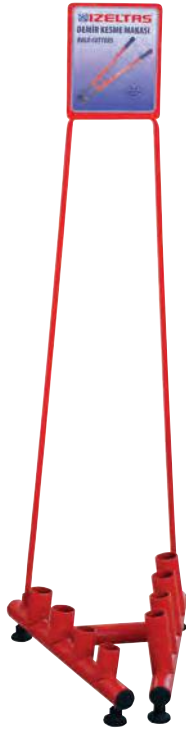

| KOD CODE | İÇERİK CONTENTS | g | TL/Ad. |
|--------------|-----------------|------|--------|
| 2350 31 6104 | Boş - Empty | 7400 | 1 |

7300

İşkence Sehpası
Display Frame for Screw Clamps



| KOD CODE | ÖLÇÜ SIZE mm | g | TL/Ad. |
|--------------|--------------|------|--------|
| 7300 31 6150 | 100x520x1420 | 8000 | 1 |

8001-8002

Çatal ve Yıldız Anahtar Sehpası Display Frame For Wrenches



Sacdan imal edilmiş, Fırın boya
Made from metal sheet, Electrostatic paint

| KOD CODE | ÖLÇÜ SIZE mm | g | İÇERİK CONTENTS | TL/Ad. |
|--------------|--------------|------|------------------|--------|
| 8001 31 6012 | 160x500 | 800 | Çatal / Open Jaw | 1 |
| 8002 31 6012 | 170x560 | 1000 | Yıldız / Ring | 1 |

8004

Dövme Çelik Mengene Sehpası Forged Steel Vice Frame



| KOD CODE | İÇERİK CONTENTS | g | TL/Ad. |
|--------------|-----------------|------|--------|
| 8004 31 6004 | Boş - Empty | 8000 | 1 |

8015

Tekerlekli Üçgen Teşhir Standı Triangular Display Frame



Sacdan imal edilmiş, Fırın boya
Made from metal sheet, Electrostatic paint

| KOD CODE | ÖLÇÜ SIZE mm | g | TL/Ad. |
|--------------|--------------|-------|--------|
| 8015 31 6001 | 520x1670 | 29500 | 1 |



(*) İşaretili olan ürünler stoklarla sınırlıdır.
Limited with stocks.

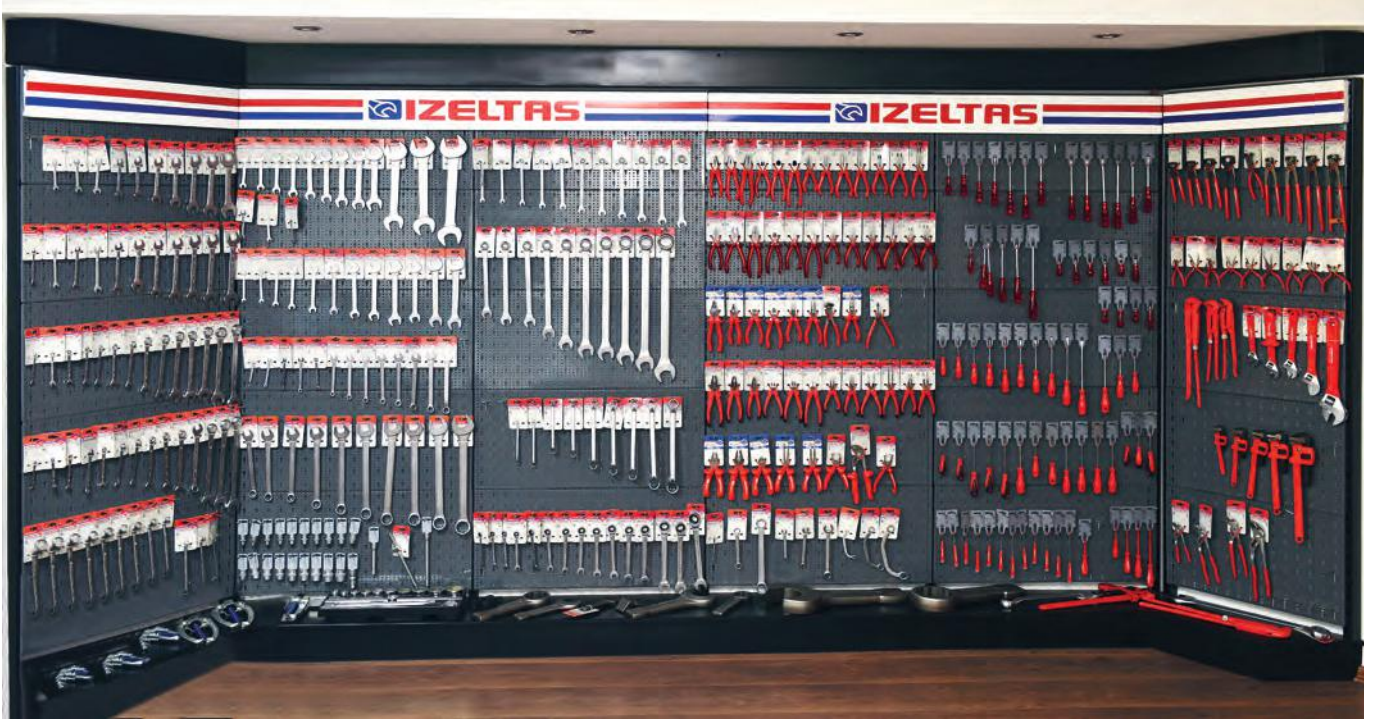

İzeltas El Aletleri Teşhir Panosu, satış noktaları için özel olarak dizayn edilmiştir. Kolayca monte edilebilen 19 ana parçadan oluşan panonun derinliği 46 cm, genişliği 100 cm, yüksekliği 220 cm'dir. Etkili görünümü ve tüm ürünleri bir arada sergileme özelliği yanında, perakende satışlarda seçme kolaylığı sağlaması bakımından da önem taşımaktadır.

İzeltas's Product Exhibition Board has been specially designed for selling points. These boards have been formed from easily mountable 19 main parts and have the dimensions as following, width 46 cm, length 100 cm and height 220 cm.

Board features an impressive looking and displays the products all together, which makes it easy to choose desired tools during retail selling activities.

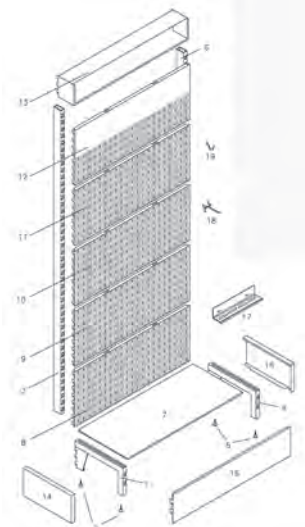

Büyük Pano
Display Panel (Empty)

Montaj Sırası / Montage Order

1. Ayak / Stand right leg
2. Plastik ayak / Plastic leg
3. Kolon / Stand right column
4. Ayak / Stand left leg
5. Plastik ayak / Plastic leg
6. Kolon / Stand left column
7. Raf / Shelf
8. Delikli pano / Drilled panel
9. Delikli pano / Drilled panel
10. Delikli pano / Drilled panel
11. Delikli pano / Drilled panel
12. Yarım delikli pano / Half - drilled panel
13. Aydınlatma alınlığı / Illumination panel
14. Yan kapak / Side cover
15. Yan kapak / Side cover
16. Ön kapak / Front cover
17. Tornavida askısı / Screwdriver hanger
18. Büyük askı / Long hanger
19. Küçük askı / Short hanger

| KOD CODE | ÖLÇÜ SIZE mm | Cinsi | g | TL/Ad. |
|--------------|--------------------|-----------|-------|--------|
| 8010 31 6001 | 460x1000x2200 | Boş/Empty | 43000 | 1 |

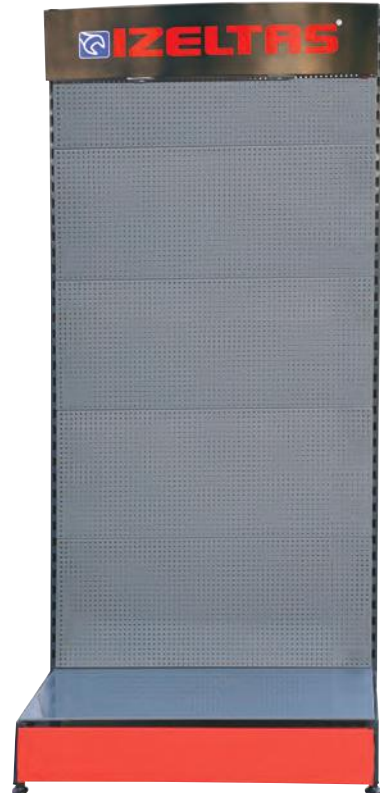

(★) İşaretili olan ürünler stoklarla sınırlıdır.
Limited with stocks.

TEKNİK BİLGİLER

TECHNICAL INFORMATIONS

Teknik Bilgiler
Technical Informations

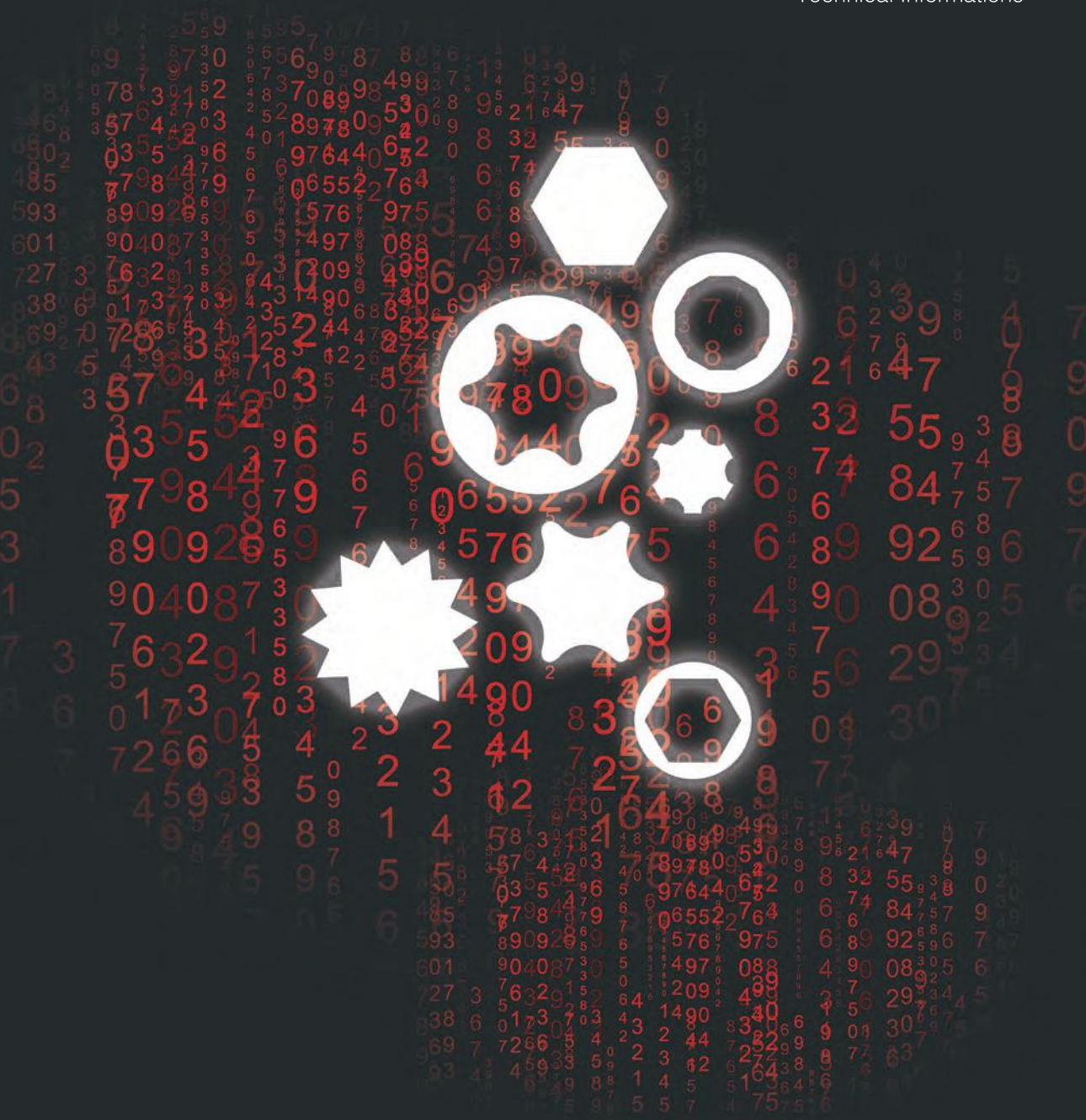



Elektrik akımı geçme (1000V üzeri hariç) ihtimali olan tüm yerlerde IEC 60900'a göre izoleli uygun el aletleri kullanılmalıdır.
Hand tools with IEC 60900 compliant isolation must be used for any work involving risk of electrical current (excluding 1000V and above).



Tozlu ve çapaklı alanlarda mutlaka gözlük kullanınız.
Make sure to wear goggles in work areas with dust and burrs.



Lokma anahtarlarınızı uygun ölçülerdeki cıvata, en geniş yüzeyde dik olarak kullanınız. Lokma anahtarların cıvataya eğik olarak takılıp kullanılması, kavrama yüzeyini azaltarak ürünün kullanım ömrünü kısıltacaktır.
Use box wrenches with bolts of appropriate size, placed perpendicularly on the largest area of contact. Use of a box wrench at an angle will reduce the gripping surface and result in a shorter useful life.



Yüksek sesli ortamlarda mutlaka kulaklık kullanınız.
Make sure to wear ear protection in work areas with high levels of noise.



Çekici amacı dışında kendinden daha sert malzemelere vurmuyunuz, eğik olarak kullanmayınız. Mantarlaşmış bölgeleri mutlaka temizleyerek kullanınız.
Do not use a hammer outside its intended purpose or to hit objects harder than the hammer. Do not hit at an angle. Make sure to clean weakened parts before use.



Kimyasal madde içeren işlerde mutlaka eldiven ve maske kullanınız. Make sure to wear gloves and facemask for works involving chemical materials.

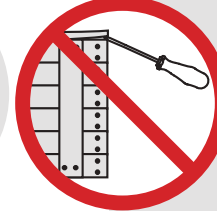

Tornavidayı amacı dışında sökme işlemlerinde kullanmayınız.
Do not use the screwdriver as a levering tool out of its intended purpose.



Anahtarlarınızı, ağız ölçüsüne uygun cıvatalarda kullanınız. Anahtar ve cıvata arasındaki ölçü uyumsuzluğu, üründe ağız aşınmasına neden olur.
Use wrenches with bolts of appropriate size. Size discrepancy between wrench and bolt will lead to wear on tool edge.



Tornavidayı amacı dışında keski gibi ya da darbeli olarak kullanmayınız.
Do not use the screwdriver as a chiselling tool or for impacting out of its intended purpose.



Anahtarların ağızına taşlama işlemi yapmayınız; sert cisimler sürterek müdahale etmeyiniz. Bu durum anahtarınızın ağız yapısını bozar.
Do not grind or expose the edge of wrenches to hard objects. This will deform the tool edge structure.



Dolapları çekerek değil iterek kullanınız.
Do not pull the set cabinets. Push to move the cabinets.



Anahtar gövdesine boru takarak kuvvet uygulamayınız. Anahtarınızın ağız yapısının bozulmasına, kırılmalara ve yaralanmalara neden olabilir.
Do not apply force to the wrench by attaching a pipe to the tool body. This may result in deformation of tool edge, breakage or injury.



Dolapların birden fazla çekmesini aynı anda açık bırakmayınız. Ağır merkezli değişerek dolabın devrilmesine neden olacaktır.
Do not leave multiple drawers of set cabinets open at the same time. This will move the centre of gravity and cause toppling.



Anahtar gövdesine çekiç ile darbe uygulamayınız. Ağız yapısında bozulmalara, kırılma ve yaralanmalara neden olabilir.
Do not hit the wrench body with a hammer. This may result in deformation of tool edge, breakage or injury.



Dolapların çekmecelerini ayağınızla kapatmaya ya da basamak, merdiven olarak kullanmaya çalışmayınız. Bu gibi durumlar yaralanmalara sebep olacaktır.
Do not use your foot to close a cabinet drawer or attempt to use cabinet drawers as a stepladder. Such actions will result in injury.

TEKNİK BİLGİLER/TECHNICAL DATA

ANAHTAR AĞZI ÖLÇÜLERİ VE VİDA ÇAPLARI SPANNER JAW WIDTH ACCROSS FLATS and THREAD DIAMETERS

| mm | DIN ISO 272 ye göre metrik | DIN ISO 272 ye göre metrik | AF | Ağız Genişliği | | Civata Çapı Whitw. BS 916 1083 | Ağız Genişliği | | |
|-----------|-------------------------------|-------------------------------|---------|----------------|--------|--|----------------|-------|--------|
| | | | | inch | mm | | inch | mm | |
| 4 | 2 | | 5/32 | 0,1562 | 3,97 | 8 BA | 0,152 | 3,86 | |
| 4,5 | 2,3 | | | | | 7 BA | 0,172 | 4,87 | |
| 5 | 2,5 | | 3/16 | 0,1875 | 4,76 | 6 BA | 0,193 | 4,90 | |
| 5,5 | 3,5 | | 7/32 | 0,2187 | 5,56 | 5 BA | 0,220 | 5,59 | |
| 6 | 26,8 | | 1/4 | 0,2500 | 6,35 | 4 BA | 0,248 | 6,30 | |
| | | | | | | 1/16 W | 0,256 | 6,50 | |
| 7 | 4 | | 9/32 | 0,2812 | 7,14 | 3 BA | 0,282 | 7,16 | |
| | | | | | | 3/32 W | 0,297 | 7,54 | |
| 7-8 | 5 | | 5/16 | 0,3125 | 7,94 | 2 BA | 0,324 | 8,23 | |
| 9 | 5 Alt | | 11/32 | 0,3438 | 8,73 | 1/8 W (3/16) | 0,340 | 8,64 | |
| | | | 3/8 | 0,3750 | 9,52 | 1 BA | 0,365 | 9,27 | |
| 8-10 | 6 | | 13/32 | 0,4062 | 10,32 | 0 BA (7/32) | 0,413 | 10,49 | |
| 11 | 7 | | 7/16 | 0,4375 | 11,11 | 3/16 W 1/4 | 0,445 | 11,30 | |
| 12 | | | | | | | | | |
| 10-13 | 8 | | 1/2 | 0,5000 | 12,70 | 1/4 W 5/16 | 0,525 | 13,34 | |
| 14* | 8 Alt | | 9/16 | 0,5625 | 14,29 | | | | |
| 15 | 10 KFZ | | 19/32 | 0,5938 | 15,08 | 5/16 W 3/8 | 0,600 | 15,24 | |
| 16 | 10 | | 5/8 | 0,6250 | 15,88 | | | | |
| 13-15-17 | 10 | | 11/16 | 0,6875 | 17,46 | | | | |
| 18 | 12 | | | | | 3/8 W 7/16 | 0,710 | 18,03 | |
| 15-18-19 | 12 | | 3/4 | 0,7500 | 19,05 | | | | |
| 20* | | | 25/32 | 0,7812 | 19,84 | | | | |
| 18-21 | 14 | | 13/16 | 0,8125 | 20,64 | 7/16 W 1/2 | 0,820 | 20,83 | |
| 22-24 | 14 | 12 | 7/8 | 0,8750 | 22,22 | | | | |
| 23* | | | | | | 1/2 W 9/16 | 0,920 | 23,37 | |
| 21-24* | 16 | | 15/16 | 0,9375 | 23,81 | | | | |
| 25*-27* | | | 1, | 1,0000 | 25,40 | | | | |
| 26* | | | | | | 9/16 W 5/8 | 1,010 | 25,65 | |
| 27 | 18 | 16 | 1.1/16 | 1,0625 | 26,99 | | | | |
| 27-28*-30 | | | | | | 5/8 W (11/16) | 1,100 | 27,94 | |
| | | | 1.1/8 | 1,1250 | 28,58 | | | | |
| 27-30-34 | 20 | | 1.3/16 | 1,1875 | 30,16 | 11/16 W 3/4 | 1,200 | 30,48 | |
| 32-36-41 | 22 | 20 | 1.1/4 | 1,2500 | 31,75 | | | | |
| | | | 1.5/16 | 1,3125 | 33,34 | 3/4 W 7/8 | 1,300 | 33,02 | |
| 34 | 22 | | 1.3/8 | 1,3750 | 34,92 | 13/16 W (15/16) | 1,390 | 35,31 | |
| 36-41 | 24 | 22 | 1.7/16 | 1,4375 | 36,51 | | | | |
| 38* | | | 1.1/2 | 1,5000 | 38,10 | 7/8 W 1 | 1,480 | 37,59 | |
| 41-46 | 27 | 24 | 1.5/8 | 1,6250 | 41,28 | | | | |
| | | | 1.11/16 | 1,6875 | 42,86 | 1. W 1.1/8 | 1,670 | 42,42 | |
| | | | 1.3/4 | 1,7500 | 44,45 | | | | |
| 46-50 | 30 | 27 | 1.13/16 | 1,8125 | 46,04 | 1.1/8 W 1.1/4 | 1,860 | 47,24 | |
| | | | 1.7/8 | 1,8750 | 47,62 | | | | |
| 50-55 | 33 | 30 | 2, | 2,0000 | 50,80 | | | | |
| | | | 2.1/16 | 2,0625 | 52,39 | 1.1/4 W 1.3/8 | 2,050 | 52,07 | |
| 55-60 | 36 | | 2.3/16 | 2,1875 | 55,56 | | | | |
| | | | 2.1/4 | 2,2500 | 57,15 | 1.3/8 W 1.1/2 | 2,220 | 56,39 | |
| 60-65 | 39 | 36 | 2.3/8 | 2,3750 | 60,32 | | | | |
| | | | 2.7/16 | 2,4375 | 61,91 | 1.1/2 W 1.5/8 | 2,410 | 61,21 | |
| 65 | 42 | | 2.9/16 | 2,5625 | 65,09 | 1.5/8 1.3/4 | 2,580 | 65,53 | |
| | | | 2.5/8 | 2,6250 | 66,68 | | | | |
| 70 | 45 | | 2.3/4 | 2,7500 | 69,85 | 1.3/4 W 2, | 2,760 | 70,10 | |
| | | | 2.13/16 | 2,8125 | 71,44 | | | | |
| 75 | 48 | | 2.15/16 | 2,9375 | 74,61 | | | | |
| | | | 3, | 3,0000 | 76,20 | (1.7/8 W) | | 76,70 | |
| 80 | 52 | | 3.1/8 | 3,1250 | 79,38 | 2. W 2.1/4 | 3,150 | 80,01 | |
| 85 | 56 | | 3.3/8 | 3,3750 | 85,72 | | | | |
| 90 | 60 | | 3.1/2 | 3,5000 | 88,90 | | 2.1/2 | 3,550 | 90,17 |
| 95 | 64 | | 3.3/4 | 3,7500 | 92,25 | | | | |
| | | | 3.7/8 | 3,8750 | 98,42 | | 2.3/4 | 3,890 | 98,81 |
| 100 | 68 | | | | | | | | |
| 105 | 72 | | 4.1/8 | 4,1250 | 104,78 | | 3, | 4,180 | 106,17 |
| 110 | 76 | | 4.1/4 | 4,2500 | 107,95 | | | | |
| 115* | 80 | | 4.1/2 | 4,5000 | 114,30 | | 3.1/4 | 4,530 | 115,06 |

ANAHTAR İÇİN MİNİMUM DÖNDÜRME MOMENTLERİ TEST TORQUE VALUES FOR SPANNERS ISO 1711-1

| mm | 0430 | 0440 | 0100 | 1800 | 1870 |
|------|------|------|------|------|------|
| | 0320 | | 0130 | | 1874 |
| | 0330 | | | | |
| | 0370 | | | | |
| 4 | | | 1,90 | | |
| 4,5* | | | 2,64 | | |
| 5 | | | 3,55 | | |
| 5,5 | | | 4,64 | | |
| 6* | 17,6 | 7,4 | 5,92 | 17,6 | |
| 7 | 25,2 | 11,4 | 9,12 | 25,2 | |
| 8 | 34,5 | 16,6 | 13,3 | 34,5 | 34,5 |
| 9* | 45,5 | 23,0 | 18,4 | 45,5 | 45,5 |
| 10 | 58,1 | 31,0 | 24,8 | 58,1 | 58,1 |
| 11 | 72,7 | 40,4 | 32,3 | 72,7 | 72,7 |
| 12 | 89,1 | 51,5 | 41,2 | 89,1 | 89,1 |
| 13 | 107 | 64,5 | 51,6 | 107 | 107 |
| 14* | 128 | 79,4 | 63,5 | 128 | 128 |
| 15 | 150 | 96,2 | 77,0 | 150 | 150 |
| 16 | 175 | 115 | 92,3 | 175 | 175 |
| 17 | 201 | 134 | 107 | 201 | 201 |
| 18 | 230 | 160 | 128 | 230 | 230 |
| 19* | 261 | 186 | 149 | 261 | 261 |
| 20* | 294 | 215 | 172 | 294 | 294 |
| 21 | 330 | 247 | 198 | 330 | 330 |
| 22* | 368 | 281 | 225 | 368 | 368 |
| 23* | 408 | 319 | 255 | 408 | 408 |
| 24 | 451 | 359 | 287 | 451 | 451 |
| 25* | 496 | 402 | 322 | 496 | 496 |
| 26* | 544 | 449 | 359 | 544 | 544 |
| 27 | 594 | 499 | 399 | 594 | 594 |
| 28* | 647 | 552 | 442 | 647 | 647 |
| 30 | 760 | 670 | 536 | 760 | 760 |
| 32* | 884 | 804 | 643 | 884 | 884 |
| 34 | 1019 | 951 | 761 | 1019 | 1019 |
| 36 | 1165 | 1117 | 994 | 1165 | 1165 |
| 41 | 1579 | 1442 | 1154 | 1579 | 1579 |
| 46 | 2067 | 1816 | 1453 | 2067 | 2067 |
| 50 | 2512 | 2145 | 1716 | 2512 | 2512 |
| 55 | 3140 | | 2077 | 3140 | 3140 |
| 60 | 3849 | | 2471 | 3849 | |
| 65 | 4021 | | | | |
| 70 | 4658 | | | | |
| 75 | 5394 | | | | |

(*) İşaretili olan ürünler stoklarla sınırlıdır.
Limited with stocks.

* Standart dışı/Not Standardised

VİDA AĞIZ ÖLÇÜLERİ
GUIDELINE FOR SCREWDRIVERS

| | M 1.6 (M 1.7) | M 2 | M 2.3 | (M 2.3) (M 2.6) | M 3 | (M 3.5) | M 4 | M 5 | M 6 | M 8 | M 10 |
|---|------------------|-----------|-----------|--------------------|-----------|-----------|-----------|-----------|----------|----------|----------|
| "Metrik Vida Metric screw" | | | | | | | | | | | |
| Düz başlı Vidalar Flat head screws | 0.4 x 3 (3.2) | 0.5 x 3.8 | 0.6 x 4.4 | 0.6 x 4.5 (5) | 0.8 x 5.5 | 0.8 x 6 | 1 x 7 | 1.2 x 8.5 | 1.6 x 10 | 2 x 13 | 2.5 x 16 |
| Düz başlı Vidalar Flat head screws | — | — | — | — | 0.8 x 6 | 0.8 x 7 | 1 x 8 | 1.2 x 10 | 1.6 x 12 | 2 x 16 | 2.5 x 20 |
| Düz başlı Vidalar (küçük) Flat head screws (small sizes) | — | — | — | 0.4 x 3.5 | 0.5 x 4 | 0.5 x 4.5 | 0.6 x 5.5 | 0.8 x 6.5 | 1 x 8 | 1.2 x 10 | 1.6 x 13 |
| Oval başlı Vidalar Oval head screws | 0.4 x 3 | 0.5 x 3.8 | — | 0.6 x 4.7 | 0.8 x 5.6 | — | — | — | — | — | — |
| Havşa başlı Vidalar Countersank head screws | 0.4 x 3 | 0.5 x 3.8 | — | 0.6 x 4.7 | 0.8 x 5.6 | 0.8 x 6.5 | 1 x 7.5 | 1.2 x 9.2 | 1.6 x 11 | 2 x 14.5 | 2.5 x 18 |

YILDIZ VİDALAR İÇİN UYGUN TORNAVİDA AĞIZ ÖLÇÜLERİ
SUITABLE TİPS FOR CROSS HEAD SCREWS

| Yıldız Ağız Ölçüsü Cross Slot Size | Metrik Vidalar Metric Screw |
|---------------------------------------|--------------------------------|
| 0 | M 1.6 - M 2 |
| 1 | M 2 - M 2.5 - M 3 |
| 2 | M 3.5 - M 5 |
| 3 | M 6 |
| 4 | M 8 - M 10 |



TEKNİK BİLGİLER/TECHNICAL DATA

METRİK VIDALAR İÇİN LOKMA SEÇİMİ GUIDE TO METRIC SIZES COVERED BY SOCKET WRENCHES FOR EACH DRIVE

| | 1107 6.3 | 1110 10 | 1113 12.5 | 1119 20 | 1125 25 | | |
|-------|-------------|------------|--------------|------------|------------|------|----|
| | 1/4" | 3/8" | 1/2" | 1/2" | 3/4" | 3/4" | 1" |
| M 2 | 4 | | | | | | |
| | 4,5 | | | | | | |
| M 2.5 | 5 | | | | | | |
| M 3 | 5,5 | | | | | | |
| M 3.5 | 6 | 6 | | | | | |
| M 4 | 7 | 7 | | | | | |
| M 5 | 8 | 8 | 8 | | | | |
| | 9 | 9 | 9 | | | | |
| M 6 | 10 | 10 | 10 | 10 | | | |
| M 7 | 11 | 11 | 11 | 11 | | | |
| | 12 | 12 | 12 | 12 | | | |
| M 8 | 13 | 13 | 13 | 13 | | | |
| | | 14 | 14 | 14 | | | |
| | | 15 | 15 | 15 | | | |
| M 10 | | 16 | 16 | 16 | | | |
| M 10 | | 17 | 17 | 17 | 17 | | |
| M 12 | | 18 | 18 | 18 | 18 | 18 | |
| M 12 | | 19 | 19 | 19 | 19 | 19 | |
| | | 20 | 20 | | | | |
| M 14 | | 21 | 21 | 21 | 21 | | |
| M 14 | | 22 | 22 | 22 | 22 | 22 | 22 |
| | | 23 | 23 | 23 | | | |
| M 16 | | | 24 | 24 | 24 | 24 | 24 |
| | | | 25 | | | | |
| | | | 26 | | | | |
| M 18 | | | 27 | 27 | 27 | 27 | 27 |
| | | | 28 | | | | |
| M 20 | | | 30 | 30 | 30 | 30 | 30 |
| M 22 | | | 32 | 32 | 32 | 32 | 32 |
| | | | | 33 | 33 | 33 | 33 |
| M 22 | | | 34 | 34 | 34 | 34 | 34 |
| M 24 | | | | 36 | 36 | 36 | 36 |
| | | | | 38 | 38 | 38 | 38 |
| M 27 | | | | 41 | 41 | 41 | 41 |
| | | | | | | 42 | |
| M 30 | | | | | 46 | 46 | 46 |
| M 33 | | | | | 50 | 50 | |
| M 36 | | | | | 55 | 55 | |
| M 39 | | | | | 60 | 60 | |
| M 42 | | | | | | 65 | |
| M 45 | | | | | | 70 | |
| M 48 | | | | | | 75 | |
| M 52 | | | | | | | |

LOKMALAR İÇİN MİN DÖNDÜRME MOMENTLERİ TEST TORQUE VALUES FOR SOCKET WRENCHES ISO 1711-1 (N-m)

| | | 6,3 1107 | 10 1110 | 12,5 1113 1114 | 20 1119 1120 | 25 1125 |
|-------|------|-------------|------------|----------------------|--------------------|------------|
| | mm | 1/4 | 3/8 | 1/2 | 3/4 | 1 |
| M2 | 4 | 10,4 | | | | |
| M 2.2 | 4.5* | 12,6 | | | | |
| M 2.5 | 5 | 15,1 | | | | |
| M 3 | 5,5 | 17,8 | | | | |
| M 3.5 | 6* | 20,6 | 23,2 | | | |
| M 4 | 7 | 26,8 | 33,2 | | | |
| M 5 | 8 | 33,6 | 45,5 | 94,1 | | |
| | 9* | 41,1 | 59,9 | 119,2 | | |
| M 6 | 10 | 49,1 | 76,7 | 147 | | |
| M 7 | 11 | 57,8 | 96 | 178 | | |
| | 12 | 67,0 | 118 | 212 | | |
| M 8 | 13 | 68,6 | 141 | 249 | | |
| | 14* | 68,6 | 169 | 288 | | |
| | 15 | | 198 | 331 | | |
| | 16 | | 225 | 377 | | |
| M 10 | 17 | | 225 | 425 | | |
| | 18 | | 225 | 477 | | |
| M 12 | 19* | | 225 | 531 | | |
| | 20* | | 225 | 569 | | |
| | 21 | | 225 | 569 | - | |
| M 14 | 22* | | 225 | 569 | 569 | |
| | 23* | | | 569 | 569 | |
| M 16 | 24 | | | 569 | 569 | |
| | 25* | | | 569 | 583 | |
| | 26* | | | 569 | 624 | |
| M 18 | 27 | | | 569 | 665 | |
| | 28* | | | 569 | 707 | |
| M 20 | 30 | | | 569 | 795 | |
| M 22 | 32* | | | 569 | 888 | |
| | 34 | | | 569 | 984 | |
| M 24 | 36 | | | | 1084 | 1677 |
| M 27 | 41 | | | | 1353 | 1910 |
| M 30 | 46 | | | | 1569 | 2143 |
| M 33 | 50 | | | | 1569 | 2329 |
| M 36 | 55 | | | | 1569 | 2562 |
| M 39 | 60 | | | | 1569 | 2795 |
| M 42 | 65 | | | | | 2795 |
| M 45 | 70 | | | | | 2795 |
| M 48 | 75 | | | | | 2795 |
| M 52 | 80 | | | | | 2795 |

(*) İşaretili olan ürünler stoklarla sınırlıdır.
Limited with stocks.

SIKMA / TEST TORK DEĞERLERİ TIGHTENING / TEST TORQUE VALUES

Önerilen (Bağlayıcı olmayan) civata sıkma torkları Nm (Newton Metre)
Suggested (Not Compulsory) Bolt Tightening Torque in Nm (Newton Meter)

Kalite Sınıfı DIN 267'ye Göre Sıkma Değerleri
Tightening Torques Values According to Quality Class DIN 267

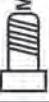
|  | 4.6 | 5.6 | 6.9 | 8.8 | 10.9 | 12.9 |
|---|-------|--------|--------|--------|--------|--------|
| M 2 | 0,123 | 0,162 | 0,314 | 0,373 | 0,520 | 0,628 |
| M 2,2 | 0,196 | 0,265 | 0,510 | 0,598 | 0,843 | 1,010 |
| M 2,5 | 0,284 | 0,373 | 0,726 | 0,863 | 1,206 | 1,451 |
| M 3 | 0,441 | 0,588 | 1,128 | 1,344 | 1,883 | 2,256 |
| M 3,5 | 0,677 | 0,902 | 1,736 | 2,060 | 2,893 | 3,481 |
| M 4 | 1,000 | 1,344 | 2,599 | 3,040 | 4,315 | 5,148 |
| M 5 | 1,916 | 2,648 | 5,099 | 6,031 | 8,483 | 10,200 |
| M 6 | 3,432 | 4,511 | 8,728 | 10,300 | 14,710 | 17,652 |
| M 7 | 5,590 | 7,453 | 14,220 | 17,162 | 24,517 | 28,439 |
| M 8 | 8,238 | 10,787 | 21,575 | 25,497 | 35,304 | 42,168 |
| M 10 | 16,67 | 21,575 | 42,168 | 50,014 | 70,608 | 85,317 |
| M 12 | 28,44 | 38,246 | 73,550 | 87,279 | 122,60 | 147,10 |
| M 14 | 45,11 | 60,801 | 116,70 | 138,30 | 194,20 | 235,40 |
| M 16 | 69,63 | 93,163 | 178,5 | 210,80 | 299,10 | 357,90 |
| M 18 | 95,12 | 127,50 | 245,20 | 289,3 | 411,90 | 490,30 |
| M 20 | 135,3 | 180,45 | 384,10 | 411,90 | 578,60 | 696,30 |
| M 22 | 182,4 | 245,16 | 470,70 | 559,00 | 784,50 | 941,40 |
| M 24 | 230,5 | 308,91 | 598,20 | 711,00 | 1000 | 1196 |
| M 27 | 343,2 | 460,90 | 887,50 | 1049 | 1481 | 1775 |
| M 30 | 465,8 | 622,72 | 1206 | 1422 | 2010 | 2403 |
| M 33 | 632,5 | 848,30 | 1628 | 1932 | 2716 | 3266 |
| M 36 | 814,0 | 1089 | 2099 | 2481 | 3491 | 4197 |
| M 39 | 1059 | 1412 | 2716 | 3226 | 4531 | 5443 |
| M 42 | 1304 | 1746 | 3364 | 3991 | 5609 | 6727 |
| M 45 | 1638 | 2177 | 4207 | 4992 | 7012 | 8414 |
| M 48 | 1981 | 2638 | 5080 | 6021 | 8473 | 10150 |
| M 52 | 2540 | 3393 | 6541 | 7747 | 10885 | 13092 |
| M 56 | 3168 | 4227 | 8149 | 9650 | 13582 | 16279 |
| M 60 | 3932 | 5247 | 10101 | 11964 | 16867 | 20202 |
| M 64 | 4737 | 6306 | 12160 | 14416 | 20300 | 24320 |

Moment Değerleri Yağlanmış Civatalar İçin %20 Azaltılmalıdır.
Torque Values Should be Decreased of 20% for Lubricated Screws

(★) İşaretili olan ürünler stoklarla sınırlıdır.
Limited with stocks.

Ölçü Birimleri Measuring Units

| | | | | |
|-------|---|---------------|-------------------|---------------------------|
| Giga | G | 1.000.000.000 | =10 ⁹ | 1GW= 1 Milyar Watt |
| Mega | M | 1.000.000 | =10 ⁶ | 1 MW= 1 Milyon Watt |
| Kilo | k | 1.000 | =10 ³ | 1 kW= Bin Watt |
| Milli | m | 0.001 | =10 ⁻³ | 1 mm= Binde Bir Watt |
| Mikro | m | 0.000001 | =10 ⁻⁶ | 1 mm= 1 Milyonda Bir Watt |
| Nano | n | 0.000000001 | =10 ⁻⁹ | 1 nm= 1 Milyarda Bir Watt |

Önemli Ölçülerin Değişim Tablosu Conversion Table For Essential Measuring Units

| | | | | |
|---------------------------------------|-------------|----|----------------------|--------------------------|
| Uzunluk Length | Metre | m | | |
| Kütle Weight | Kilogram | kg | | |
| Zaman Time | Saniye | s | | |
| Kuvvet Force | Newton | N | =kg m/s ² | 1 N= 0.102 kp |
| Döndürme Mom. Torque | Newtonmetre | | | 9.81 Nm= 1kpm |
| İş Enerjisi Work | Joule | J | =Nm | |
| Isı Enerjisi Heat | Joule | J | | 1 J= 0.239 cal |
| Güç Power | Watt | W | =Nm/s | 1 kW= 1.36 PS=860 kcal/h |
| Basınç Pressure | Pascal | Pa | =N/m ² | 100.000 Pa=1 bar=10 mWS |
| Elektrik Akımı Electricity Current | Amper | A | | |
| Sıcaklık Temperature | Kelvin | K | | 1K= -272.15 °C |

Döndürme Momenti Dönüşüm Tablosu Conversion Table For Bending Moments

| Var Olan Ölçüler/ present units | İstenen Ölçüler / Wanted Units | | | | | |
|--|--------------------------------|---------|---------|---------|----------|----------|
| | =Ncm | =Nm | =kpcm | =kpm | =lbf.in. | =lbf.ft. |
| Ncm | 1 | 0.01 | 0.10197 | 0.00102 | 0.0885 | 0.00738 |
| Nm | 100 | 1 | 10.197 | 0.10197 | 8.851 | 0.7376 |
| kpcm | 9.807 | 0.09807 | 1 | 0.01 | 0.868 | 0.0723 |
| kpm | 980.07 | 9.807 | 100 | 1 | 86.796 | 7.233 |
| lbf.in. | 11.298 | 0.11298 | 1.152 | 0.01152 | 1 | 0.0833 |
| lbf.ft. | 135.58 | 1.3558 | 13.825 | 0.13825 | 12 | 1 |

Newton-Metre ve Librefoot Dönüşüm Tablosu Conversion Table Of Newton-Meter And Librefoot (1 Nm=0.738 lbf.ft.)

| Nm | ft.,lbs. | | | | | | | | | |
|-----|----------|-------|-------|-------|-------|-------|-------|-------|-------|-------|
| | 0 | 1 | 2 | 3 | 4 | 5 | 6 | 7 | 8 | 9 |
| 0 | 0 | 0.74 | 1.48 | 2.21 | 2.95 | 3.69 | 4.43 | 5.17 | 5.90 | 6.64 |
| 10 | 7.38 | 8.12 | 8.86 | 9.59 | 10.33 | 11.07 | 11.81 | 12.54 | 13.28 | 14.02 |
| 20 | 14.76 | 15.50 | 16.2 | 16.97 | 17.71 | 18.45 | 19.19 | 19.93 | 20.65 | 21.40 |
| 30 | 22.14 | 22.88 | 23.62 | 24.35 | 25.10 | 25.83 | 26.57 | 27.31 | 28.04 | 28.78 |
| 40 | 29.52 | 30.26 | 31.00 | 31.73 | 32.47 | 33.21 | 33.95 | 34.69 | 35.42 | 36.16 |
| 50 | 36.90 | 37.64 | 38.38 | 39.11 | 39.85 | 40.59 | 41.33 | 42.07 | 42.80 | 43.54 |
| 60 | 44.28 | 45.02 | 45.76 | 46.49 | 47.23 | 47.97 | 48.71 | 49.45 | 50.18 | 50.92 |
| 70 | 51.66 | 52.40 | 53.14 | 53.87 | 54.61 | 55.35 | 56.09 | 56.83 | 57.56 | 58.30 |
| 80 | 59.04 | 59.78 | 60.52 | 61.25 | 62.00 | 62.73 | 63.47 | 64.21 | 64.94 | 65.68 |
| 90 | 66.42 | 67.16 | 67.90 | 68.63 | 69.37 | 70.11 | 70.85 | 71.59 | 72.32 | 73.06 |
| 100 | 73.80 | 74.54 | 75.28 | 76.01 | 76.75 | 77.49 | 78.23 | 78.97 | 79.70 | 80.44 |

Librefoot ve Newton-Metre Dönüşüm Tablosu Conversion Table Of Librefoot And Newton-Meter (1 lbf.ft.=1.356 Nm)

| ft.- lbs. | Nm | | | | | | | | | |
|--------------|--------|--------|--------|--------|--------|--------|--------|--------|--------|--------|
| | 0 | 1 | 2 | 3 | 4 | 5 | 6 | 7 | 8 | 9 |
| 0 | 0 | 1.36 | 2.71 | 4.07 | 5.42 | 6.78 | 8.14 | 9.49 | 10.85 | 12.20 |
| 10 | 13.56 | 14.92 | 16.27 | 17.63 | 18.98 | 20.34 | 21.70 | 23.05 | 24.41 | 25.76 |
| 20 | 27.12 | 28.48 | 29.83 | 31.19 | 32.54 | 33.90 | 35.26 | 36.61 | 37.97 | 39.32 |
| 30 | 40.68 | 42.04 | 43.39 | 44.75 | 46.10 | 47.46 | 48.82 | 50.17 | 51.53 | 52.88 |
| 40 | 54.24 | 55.60 | 56.95 | 58.31 | 59.66 | 61.02 | 62.38 | 63.73 | 65.09 | 66.44 |
| 50 | 67.80 | 69.16 | 70.51 | 71.87 | 73.22 | 74.58 | 75.94 | 77.29 | 78.65 | 80.00 |
| 60 | 81.36 | 82.72 | 84.07 | 85.43 | 86.78 | 88.14 | 89.50 | 90.85 | 92.21 | 93.56 |
| 70 | 94.92 | 96.28 | 97.63 | 98.99 | 100.34 | 101.70 | 103.06 | 104.41 | 105.77 | 107.12 |
| 80 | 108.48 | 109.84 | 111.19 | 112.55 | 113.90 | 115.26 | 116.62 | 117.97 | 119.33 | 120.68 |
| 90 | 122.04 | 123.40 | 124.75 | 126.11 | 127.46 | 128.82 | 130.18 | 131.53 | 132.89 | 134.24 |
| 100 | 135.60 | 136.96 | 138.31 | 139.67 | 141.02 | 142.38 | 143.74 | 145.09 | 146.45 | 147.80 |

Newton-Metre ve Kilopound-Metre Dönüşüm Tablosu Conversion Table Of Newton-Meter and Kilopound-Meter (1 Nm=0.102 kpm)

| Nm | kpm | | | | | | | | | |
|------|--------|--------|--------|--------|--------|--------|--------|--------|--------|--------|
| | 0 | 1 | 2 | 3 | 4 | 5 | 6 | 7 | 8 | 9 |
| 0 | 0.00 | 1.02 | 2.04 | 3.06 | 4.08 | 5.10 | 6.12 | 7.14 | 8.16 | 9.18 |
| 100 | 10.20 | 11.22 | 12.24 | 13.26 | 14.28 | 15.30 | 16.31 | 17.33 | 18.35 | 19.37 |
| 200 | 20.39 | 21.41 | 22.43 | 23.45 | 24.47 | 25.49 | 26.51 | 27.53 | 28.55 | 29.57 |
| 300 | 30.59 | 31.61 | 32.63 | 33.65 | 34.67 | 35.69 | 36.71 | 37.73 | 38.75 | 39.77 |
| 400 | 40.79 | 41.81 | 42.83 | 43.85 | 44.87 | 45.89 | 46.91 | 47.93 | 48.95 | 49.97 |
| 500 | 50.99 | 52.00 | 53.02 | 54.04 | 55.06 | 56.08 | 57.10 | 58.12 | 59.14 | 60.16 |
| 600 | 61.18 | 62.20 | 63.22 | 64.24 | 65.26 | 66.28 | 67.30 | 68.32 | 69.34 | 70.36 |
| 700 | 71.38 | 72.40 | 73.42 | 74.44 | 75.46 | 76.48 | 77.50 | 78.52 | 79.54 | 80.56 |
| 800 | 81.58 | 82.60 | 83.62 | 84.64 | 85.66 | 86.68 | 87.70 | 88.71 | 89.73 | 90.75 |
| 900 | 91.77 | 92.79 | 93.81 | 94.83 | 95.85 | 96.87 | 97.89 | 98.91 | 99.93 | 100.95 |
| 1000 | 101.97 | 102.99 | 104.01 | 105.03 | 106.05 | 107.07 | 108.09 | 109.11 | 110.13 | 111.15 |



Sertlik Dönüşüm Tablosu

Hardness Conversion Table

| Vickers Sertlik Hardness | Brinell Sertlik Hardness | Rockwell Sertlik Hardness | | Çekme dayanımı Tensile Strength |
|--------------------------------|--------------------------------|---------------------------------|------|---------------------------------------|
| | | HRB | HRC | |
| HV 30 | HB 30 | HRB | HRC | sB N/mm ² |
| 80 | 80.7 | 36.4 | - | 270 |
| 85 | 85 | 42.4 | - | 290 |
| 90 | 90 | 47.4 | - | 310 |
| 95 | 95 | 52.00 | - | 320 |
| 100 | 100 | 56.4 | - | 340 |
| 105 | 105 | 60.0 | - | 360 |
| 110 | 110 | 63.4 | - | 380 |
| 115 | 115 | 66.4 | - | 390 |
| 120 | 120 | 69.4 | - | 410 |
| 125 | 125 | 72.0 | - | 420 |
| 130 | 130 | 74.4 | - | 440 |
| 135 | 135 | 76.4 | - | 460 |
| 140 | 140 | 78.4 | - | 470 |
| 145 | 145 | 80.4 | - | 490 |
| 150 | 150 | 82.2 | - | 500 |
| 155 | 155 | 83.8 | - | 520 |
| 160 | 160 | 85.4 | - | 540 |
| 165 | 165 | 86.8 | - | 550 |
| 170 | 170 | 88.2 | - | 570 |
| 175 | 175 | 89.6 | - | 590 |
| 180 | 180 | 90.8 | - | 600 |
| 185 | 185 | 91.8 | - | 620 |
| 195 | 190 | 91.5 | - | 640 |
| 200 | 195 | 94.0 | - | 660 |
| 200 | 200 | 95.0 | - | 670 |
| 205 | 205 | 95.8 | - | 680 |
| 210 | 210 | 96.6 | - | 710 |
| 215 | 215 | 97.4 | - | 720 |
| 220 | 220 | 98.2 | - | 730 |
| 225 | 225 | 99.0 | - | 750 |
| 230 | 230 | - | 19.2 | 760 |
| 235 | 235 | - | 20.2 | 780 |
| 240 | 240 | - | 21.2 | 800 |
| 245 | 245 | - | 22.1 | 820 |
| 250 | 250 | - | 23.0 | 830 |
| 255 | 255 | - | 23.8 | 850 |
| 260 | 260 | - | 24.6 | 870 |
| 265 | 265 | - | 25.4 | 880 |
| 280 | 280 | - | 27.1 | 900 |
| 275 | 275 | - | 26.9 | 920 |
| 280 | 280 | - | 27.6 | 940 |
| 285 | 285 | - | 28.3 | 950 |
| 290 | 290 | - | 29.0 | 970 |
| 295 | 295 | - | 29.6 | 990 |
| 300 | 300 | - | 30.3 | 1010 |
| 310 | 310 | - | 31.5 | 1040 |
| 320 | 320 | - | 32.7 | 1080 |
| 330 | 330 | - | 33.8 | 1110 |

| Vickers Sertlik Hardness | Brinell Sertlik Hardness | Rockwell Sertlik Hardness | | Çekme dayanımı Tensile Strength |
|--------------------------------|--------------------------------|---------------------------------|------|---------------------------------------|
| | | HRB | HRC | |
| HV 30 | HB 30 | HRB | HRC | sB N/mm ² |
| 340 | 340 | - | 34.9 | 1140 |
| 350 | 350 | - | 36.0 | 1170 |
| 360 | 359 | - | 37.0 | 1200 |
| 370 | 368 | - | 38.0 | 1260 |
| 380 | 376 | - | 38.9 | 1260 |
| 390 | 385 | - | 39.8 | 1290 |
| 400 | 392 | - | 40.7 | 1320 |
| 410 | 400 | - | 41.5 | 1350 |
| 420 | 408 | - | 42.4 | 1380 |
| 440 | 423 | - | 44.0 | 1430 |
| 450 | 430 | - | 44.8 | 1460 |
| 460 | - | - | 45.6 | - |
| 470 | - | - | 46.3 | - |
| 480 | - | - | 47.0 | - |
| 490 | - | - | 47.7 | - |
| 500 | - | - | 48.3 | - |
| 510 | - | - | 49.1 | - |
| 520 | - | - | 49.7 | - |
| 530 | - | - | 50.4 | - |
| 540 | - | - | 51.0 | - |
| 550 | - | - | 51.6 | - |
| 560 | - | - | 52.2 | - |
| 570 | - | - | 52.8 | - |
| 580 | - | - | 53.3 | - |
| 590 | - | - | 53.9 | - |
| 600 | - | - | 54.4 | - |
| 610 | - | - | 55.0 | - |
| 620 | - | - | 55.5 | - |
| 630 | - | - | 56.0 | - |
| 640 | - | - | 56.5 | - |
| 650 | - | - | 57.0 | - |
| 660 | - | - | 57.5 | - |
| 670 | - | - | 58.0 | - |
| 680 | - | - | 58.5 | - |
| 690 | - | - | 59.0 | - |
| 700 | - | - | 59.5 | - |
| 720 | - | - | 60.4 | - |
| 740 | - | - | 61.2 | - |
| 760 | - | - | 62.0 | - |
| 780 | - | - | 62.8 | - |
| 800 | - | - | 63.6 | - |
| 820 | - | - | 64.3 | - |
| 840 | - | - | 65.0 | - |
| 860 | - | - | 65.7 | - |
| 880 | - | - | 66.3 | - |
| 900 | - | - | 66.9 | - |
| 920 | - | - | 67.5 | - |
| 940 | - | - | 68.0 | - |

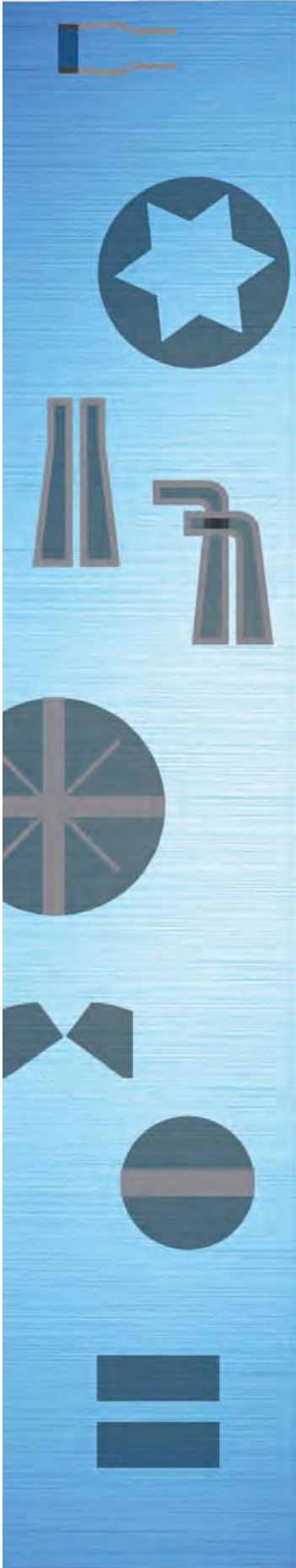

Semboller / Symbols

**Anahtar Ağız
Size**



**Ağız Açıklığı
Opening Limit of Jaws**



**Altı Köşe Lokma Bijon
Anahtar Ağızı
Six Point Sockets**



**Sekiz Köşe Anahtar Ağızı
Eight Point Wrench**



**On iki Köşe Anahtar Ağızı
Twelve Point Wrench**



**Kare Adaptör
Square Adapter**



**Kovan Anahtar
Tubular Socket Wrench**



**Bir Ağız Bijon Anahtar
Single Ended Rim Wrench**



**TORX® Lokma Anahtar
TORX Socket**



**Düz Uç
Flat Tip**



**Yıldız Uç
PHILLIPS® Tip**



**POZIDRIV® Yıldız Uç
POZIDRIV® Tip**



**TORX® Uç
TORX® Tip**



**Delikli TORX® Uç
TORX® with hole**



**Bits Tutucular
Bit Holders**



**Allen Anahtar
Hexagonal Allen Keys**



**Segman
Circlip**



**Gövde Ağırlık
Weight of Body**



**Tapa Anahtar
Wrench for Carter Case**



**İşence
Screw Clamp**



**Çektirme
Puller**

| in. | dec.in. | 0" | 1" | 2" | 3" | 4" | 5" | 6" | 7" | 8" | 9" | 10" | 11" |
|-------|-----------|------------------|----------|----------|-----------|-----------|-----------|-----------|-----------|-----------|-----------|-----------|-----------|
| | | millimeters (mm) | | | | | | | | | | | |
| 0 | 0 | 0 | 25.400 0 | 50.800 0 | 76.200 0 | 101.600 0 | 127.000 0 | 152.400 0 | 177.800 0 | 203.200 0 | 228.600 0 | 254.000 0 | 279.400 0 |
| 1/64 | 0.015 625 | 0.396 9 | 25.796 9 | 51.196 9 | 76.596 9 | 101.996 9 | 127.396 9 | 152.796 9 | 178.196 9 | 203.596 9 | 228.996 9 | 254.396 9 | 279.796 9 |
| 1/32 | 0.031 25 | 0.793 8 | 26.193 8 | 51.593 8 | 76.993 8 | 102.393 8 | 127.793 8 | 153.193 8 | 178.593 8 | 203.993 8 | 229.393 8 | 254.793 8 | 280.193 8 |
| 3/64 | 0.046 875 | 1.190 6 | 26.590 6 | 51.990 6 | 77.390 6 | 102.790 6 | 128.190 6 | 153.590 6 | 178.990 6 | 204.390 6 | 229.790 6 | 255.190 6 | 280.590 6 |
| 1/16 | 0.062 5 | 1.587 5 | 26.987 5 | 52.387 5 | 77.787 5 | 103.187 5 | 128.587 5 | 153.987 5 | 179.387 5 | 204.787 5 | 230.187 5 | 255.587 5 | 280.987 5 |
| 5/64 | 0.078 125 | 1.984 4 | 27.384 4 | 52.784 4 | 78.184 4 | 103.584 4 | 128.984 4 | 154.384 4 | 179.784 4 | 205.184 4 | 230.584 4 | 255.984 4 | 281.384 4 |
| 3/32 | 0.093 75 | 2.381 2 | 27.781 2 | 53.181 2 | 78.581 2 | 103.981 2 | 129.381 2 | 154.781 2 | 180.181 2 | 205.581 2 | 230.981 2 | 256.381 2 | 281.781 2 |
| 7/64 | 0.109 375 | 2.778 1 | 28.178 1 | 53.578 1 | 78.978 1 | 104.378 1 | 129.778 1 | 155.178 1 | 180.578 1 | 205.978 1 | 231.378 1 | 256.778 1 | 282.178 1 |
| 1/8 | 0.125 | 3.175 0 | 28.575 0 | 53.975 0 | 79.375 0 | 104.775 0 | 130.175 0 | 155.575 0 | 180.975 0 | 206.375 0 | 231.775 0 | 257.175 0 | 282.575 0 |
| 9/64 | 0.140 625 | 3.571 9 | 28.971 9 | 54.371 9 | 79.771 9 | 105.171 9 | 130.571 9 | 155.971 9 | 181.371 9 | 206.771 9 | 232.171 9 | 257.571 9 | 282.971 9 |
| 5/32 | 0.156 25 | 3.968 8 | 29.368 8 | 54.768 8 | 80.168 8 | 105.568 8 | 130.968 8 | 156.368 8 | 181.768 8 | 207.168 8 | 232.568 8 | 257.968 8 | 283.368 8 |
| 11/64 | 0.171 875 | 4.365 6 | 29.765 6 | 55.165 6 | 80.565 6 | 105.965 6 | 131.365 6 | 156.765 6 | 182.165 6 | 207.565 6 | 232.965 6 | 258.365 6 | 283.765 6 |
| 3/16 | 0.187 5 | 4.762 5 | 30.162 5 | 55.562 5 | 80.962 5 | 106.362 5 | 131.762 5 | 157.162 5 | 182.562 5 | 207.962 5 | 233.362 5 | 258.762 5 | 284.162 5 |
| 13/64 | 0.203 125 | 5.159 4 | 30.559 4 | 55.959 4 | 81.359 4 | 106.759 4 | 132.159 4 | 157.559 4 | 182.959 4 | 208.359 4 | 233.759 4 | 259.159 4 | 284.559 4 |
| 7/32 | 0.218 75 | 5.556 2 | 30.956 2 | 56.356 2 | 81.756 2 | 107.156 2 | 132.556 2 | 157.956 2 | 183.356 2 | 208.756 2 | 234.156 2 | 259.556 2 | 284.956 2 |
| 15/64 | 0.234 375 | 5.953 1 | 31.353 1 | 56.753 1 | 82.153 1 | 107.553 1 | 132.953 1 | 158.353 1 | 183.753 1 | 209.153 1 | 234.553 1 | 259.953 1 | 285.353 1 |
| 1/4 | 0.25 | 6.350 0 | 31.750 0 | 57.150 0 | 82.550 0 | 107.950 0 | 133.350 0 | 158.750 0 | 184.150 0 | 209.550 0 | 234.950 0 | 260.350 0 | 285.750 0 |
| 17/64 | 0.265 625 | 6.746 9 | 32.146 9 | 57.546 9 | 82.946 9 | 108.346 9 | 133.746 9 | 159.146 9 | 184.546 9 | 209.946 9 | 235.346 9 | 260.746 9 | 286.146 9 |
| 9/32 | 0.281 25 | 7.143 8 | 32.543 8 | 57.943 8 | 83.343 8 | 108.743 8 | 134.143 8 | 159.543 8 | 184.943 8 | 210.343 8 | 235.743 8 | 261.143 8 | 286.543 8 |
| 19/64 | 0.296 875 | 7.540 6 | 32.940 6 | 58.340 6 | 83.740 6 | 109.140 6 | 134.540 6 | 159.940 6 | 185.340 6 | 210.740 6 | 236.140 6 | 261.540 6 | 286.940 6 |
| 5/16 | 0.312 5 | 7.937 5 | 33.337 5 | 58.737 5 | 84.137 5 | 109.537 5 | 134.937 5 | 160.337 5 | 185.737 5 | 211.137 5 | 236.537 5 | 261.937 5 | 287.337 5 |
| 21/64 | 0.328 125 | 8.334 4 | 33.734 4 | 59.134 4 | 84.534 4 | 109.934 4 | 135.334 4 | 160.734 4 | 186.134 4 | 211.534 4 | 236.934 4 | 262.334 4 | 287.734 4 |
| 11/32 | 0.343 75 | 8.731 2 | 34.131 2 | 59.531 2 | 84.931 2 | 110.331 2 | 135.731 2 | 161.131 2 | 186.531 2 | 211.931 2 | 237.331 2 | 262.731 2 | 288.131 2 |
| 23/64 | 0.359 375 | 9.128 1 | 34.528 1 | 59.928 1 | 85.328 1 | 110.728 1 | 136.128 1 | 161.528 1 | 186.928 1 | 212.328 1 | 237.728 1 | 263.128 1 | 288.528 1 |
| 3/8 | 0.375 | 9.525 0 | 34.925 0 | 60.325 0 | 85.725 0 | 111.125 0 | 136.525 0 | 161.925 0 | 187.325 0 | 212.725 0 | 238.125 0 | 263.525 0 | 288.925 0 |
| 25/64 | 0.390 625 | 9.921 9 | 35.321 9 | 60.721 9 | 86.121 9 | 111.521 9 | 136.921 9 | 162.321 9 | 187.721 9 | 213.121 9 | 238.521 9 | 263.921 9 | 289.321 9 |
| 13/32 | 0.406 25 | 10.318 8 | 35.718 8 | 61.118 8 | 86.518 8 | 111.918 8 | 137.318 8 | 162.718 8 | 188.118 8 | 213.518 8 | 238.918 8 | 264.318 8 | 289.718 8 |
| 27/64 | 0.421 875 | 10.715 6 | 36.115 6 | 61.515 6 | 86.915 6 | 112.315 6 | 137.715 6 | 163.115 6 | 188.515 6 | 213.915 6 | 239.315 6 | 264.715 6 | 290.115 6 |
| 7/16 | 0.437 5 | 11.112 5 | 36.512 5 | 61.912 5 | 87.312 5 | 112.712 5 | 138.112 5 | 163.512 5 | 188.912 5 | 214.312 5 | 239.712 5 | 265.112 5 | 290.512 5 |
| 29/64 | 0.453 125 | 11.509 4 | 36.909 4 | 62.309 4 | 87.709 4 | 113.109 4 | 138.509 4 | 163.909 4 | 189.309 4 | 214.709 4 | 240.109 4 | 265.509 4 | 290.909 4 |
| 15/32 | 0.468 75 | 11.906 2 | 37.306 2 | 62.706 2 | 88.106 2 | 113.506 2 | 138.906 2 | 164.306 2 | 189.706 2 | 215.106 2 | 240.506 2 | 265.906 2 | 291.306 2 |
| 31/64 | 0.484 375 | 12.303 1 | 37.703 1 | 63.103 1 | 88.503 1 | 113.903 1 | 139.303 1 | 164.703 1 | 190.103 1 | 215.503 1 | 240.903 1 | 266.303 1 | 291.703 1 |
| 1/2 | 0.5 | 12.700 0 | 38.100 0 | 63.500 0 | 88.900 0 | 114.300 0 | 139.700 0 | 165.100 0 | 190.500 0 | 215.900 0 | 241.300 0 | 266.700 0 | 292.100 0 |
| 33/64 | 0.515 625 | 13.096 9 | 38.496 9 | 63.896 9 | 89.296 9 | 114.696 9 | 140.096 9 | 165.496 9 | 190.896 9 | 216.296 9 | 241.696 9 | 267.096 9 | 292.496 9 |
| 17/32 | 0.531 25 | 13.493 8 | 38.893 8 | 64.293 8 | 89.693 8 | 115.093 8 | 140.493 8 | 165.893 8 | 191.293 8 | 216.693 8 | 242.093 8 | 267.493 8 | 292.893 8 |
| 35/64 | 0.546 875 | 13.890 6 | 39.290 6 | 64.690 6 | 90.090 6 | 115.490 6 | 140.890 6 | 166.290 6 | 191.690 6 | 217.090 6 | 242.490 6 | 267.890 6 | 293.290 6 |
| 9/16 | 0.562 5 | 14.287 5 | 39.687 5 | 65.087 5 | 90.487 5 | 115.887 5 | 141.287 5 | 166.687 5 | 192.087 5 | 217.487 5 | 242.887 5 | 268.287 5 | 293.687 5 |
| 37/64 | 0.578 125 | 14.684 4 | 40.084 4 | 65.484 4 | 90.884 4 | 116.284 4 | 141.684 4 | 167.084 4 | 192.484 4 | 217.884 4 | 243.284 4 | 268.684 4 | 294.084 4 |
| 19/32 | 0.593 75 | 15.081 2 | 40.481 2 | 65.881 2 | 91.281 2 | 116.681 2 | 142.081 2 | 167.481 2 | 192.881 2 | 218.281 2 | 243.681 2 | 269.081 2 | 294.481 2 |
| 39/64 | 0.609 375 | 15.478 1 | 40.878 1 | 66.278 1 | 91.678 1 | 117.078 1 | 142.478 1 | 167.878 1 | 193.278 1 | 218.678 1 | 244.078 1 | 269.478 1 | 294.878 1 |
| 5/8 | 0.625 | 15.875 0 | 41.275 0 | 66.675 0 | 92.075 0 | 117.475 0 | 142.875 0 | 168.275 0 | 193.675 0 | 219.075 0 | 244.475 0 | 269.875 0 | 295.275 0 |
| 41/64 | 0.640 625 | 16.271 9 | 41.671 9 | 67.071 9 | 92.471 9 | 117.871 9 | 143.271 9 | 168.671 9 | 194.071 9 | 219.471 9 | 244.871 9 | 270.271 9 | 295.671 9 |
| 21/32 | 0.656 25 | 16.668 8 | 42.068 8 | 67.468 8 | 92.868 8 | 118.268 8 | 143.668 8 | 169.068 8 | 194.468 8 | 219.868 8 | 245.268 8 | 270.668 8 | 296.068 8 |
| 43/64 | 0.671 875 | 17.065 6 | 42.465 6 | 67.865 6 | 93.265 6 | 118.665 6 | 144.065 6 | 169.465 6 | 194.865 6 | 220.265 6 | 245.665 6 | 271.065 6 | 296.465 6 |
| 11/16 | 0.687 5 | 17.462 5 | 42.862 5 | 68.262 5 | 93.662 5 | 119.062 5 | 144.462 5 | 169.862 5 | 195.262 5 | 220.662 5 | 246.062 5 | 271.462 5 | 296.862 5 |
| 45/64 | 0.703 125 | 17.859 4 | 43.259 4 | 68.659 4 | 94.059 4 | 119.459 4 | 144.859 4 | 170.259 4 | 195.659 4 | 221.059 4 | 246.459 4 | 271.859 4 | 297.259 4 |
| 23/32 | 0.718 75 | 18.256 2 | 43.656 2 | 69.056 2 | 94.456 2 | 119.856 2 | 145.256 2 | 170.656 2 | 196.056 2 | 221.456 2 | 246.856 2 | 272.256 2 | 297.656 2 |
| 47/64 | 0.734 375 | 18.653 1 | 44.053 1 | 69.453 1 | 94.853 1 | 120.253 1 | 145.653 1 | 171.053 1 | 196.453 1 | 221.853 1 | 247.253 1 | 272.653 1 | 298.053 1 |
| 3/4 | 0.75 | 19.050 0 | 44.450 0 | 69.850 0 | 95.250 0 | 120.650 0 | 146.050 0 | 171.450 0 | 196.850 0 | 222.250 0 | 247.650 0 | 273.050 0 | 298.450 0 |
| 49/64 | 0.765 625 | 19.446 9 | 44.846 9 | 70.246 9 | 95.646 9 | 121.046 9 | 146.446 9 | 171.846 9 | 197.246 9 | 222.646 9 | 248.046 9 | 273.446 9 | 298.846 9 |
| 25/32 | 0.781 25 | 19.843 8 | 45.243 8 | 70.643 8 | 96.043 8 | 121.443 8 | 146.843 8 | 172.243 8 | 197.643 8 | 223.043 8 | 248.443 8 | 273.843 8 | 299.243 8 |
| 51/64 | 0.796 875 | 20.240 6 | 45.640 6 | 71.040 6 | 96.440 6 | 121.840 6 | 147.240 6 | 172.640 6 | 198.040 6 | 223.440 6 | 248.840 6 | 274.240 6 | 299.640 6 |
| 13/16 | 0.812 5 | 20.637 5 | 46.037 5 | 71.437 5 | 96.837 5 | 122.237 5 | 147.637 5 | 173.037 5 | 198.437 5 | 223.837 5 | 249.237 5 | 274.637 5 | 300.037 5 |
| 53/64 | 0.828 125 | 21.034 4 | 46.434 4 | 71.834 4 | 97.234 4 | 122.634 4 | 148.034 4 | 173.434 4 | 198.834 4 | 224.234 4 | 249.634 4 | 275.034 4 | 300.434 4 |
| 27/32 | 0.843 75 | 21.431 2 | 46.831 2 | 72.231 2 | 97.631 2 | 123.031 2 | 148.431 2 | 173.831 2 | 199.231 2 | 224.631 2 | 250.031 2 | 275.431 2 | 300.831 2 |
| 55/64 | 0.859 375 | 21.828 1 | 47.228 1 | 72.628 1 | 98.028 1 | 123.428 1 | 148.828 1 | 174.228 1 | 199.628 1 | 225.028 1 | 250.428 1 | 275.828 1 | 301.228 1 |
| 7/8 | 0.875 | 22.225 0 | 47.625 0 | 73.025 0 | 98.425 0 | 123.825 0 | 149.225 0 | 174.625 0 | 200.025 0 | 225.425 0 | 250.825 0 | 276.225 0 | 301.625 0 |
| 57/64 | 0.890 625 | 22.621 9 | 48.021 9 | 73.421 9 | 98.821 9 | 124.221 9 | 149.621 9 | 175.021 9 | 200.421 9 | 225.821 9 | 251.221 9 | 276.621 9 | 302.021 9 |
| 29/32 | 0.906 25 | 23.018 8 | 48.418 8 | 73.818 8 | 99.218 8 | 124.618 8 | 150.018 8 | 175.418 8 | 200.818 8 | 226.218 8 | 251.618 8 | 277.018 8 | 302.418 8 |
| 59/64 | 0.921 875 | 23.415 6 | 48.815 6 | 74.215 6 | 99.615 6 | 125.015 6 | 150.415 6 | 175.815 6 | 201.215 6 | 226.615 6 | 252.015 6 | 277.415 6 | 302.815 6 |
| 15/16 | 0.937 5 | 23.812 5 | 49.212 5 | 74.612 5 | 100.012 5 | 125.412 5 | 150.812 5 | 176.212 5 | 201.612 5 | 227.012 5 | 252.412 5 | 277.812 5 | 303.212 5 |
| 61/64 | 0.953 125 | 24.209 4 | 49.609 4 | 75.009 4 | 100.409 4 | 125.809 4 | 151.209 4 | 176.609 4 | 202.009 4 | 227.409 4 | 252.809 4 | 278.209 4 | 303.609 4 |
| 31/32 | 0.968 75 | 24.606 2 | 50.006 2 | 75.406 2 | 100.806 2 | 126.206 2 | 151.606 2 | 177.006 2 | 202.406 2 | 227.806 2 | 253.206 2 | 278.606 2 | 304.006 2 |
| 63/64 | 0.984 375 | 25.003 1 | 50.403 1 | 75.803 1 | 101.203 1 | 126 | | | | | | | |

KALİTE GÜVENCE TESTLERİ / QUALITY ASSURANCE TEST



YASAL UYARILAR / LEGAL NOTIE

Bu katalog, önceki baskıların yerine geçer. Katalog içerisinde yer alan ürünlerin teknik özellikleri, görünümü, ölçüleri katalogun yayımlandığı tarihteki mevcut şartları temsil etmektedir. Bu sebeple sipariş verilmeden önce mutlaka firma ile iletişime geçerek sipariş tarihindeki ürünlere ilişkin güncel bilgileri öğrenmenizi öneririz. Katalogta belirtilen ürünlere ait teknik özellikler, görünüm veya ölçü gibi özelliklerin sipariş tarihindeki ürünler ile aynı olmamasından kaynaklı firmanın her ne nam altında olursa olsun hiçbir sorumluluğu bulunmamaktadır. Bu bilgiler doğrultusunda, firma işbu katalog içeriğinde yer alan bilgilerden veya görsel malzemedan kaynaklanabilecek hatalardan, maddi veya manevi zararlardan hiç bir şekil ve surette sorumlu değildir.

Firma katalog içeriğinde yer alan bilgiler veya ürünler ile ilgili önceden haber vermeksizin tek taraflı değişiklikler yapabilir. Firma dilediği zaman, ürünlerinin teknik özelliklerini, görsellerini veya ölçülerini veya ürünlerini tamamen veya kısmen değiştirme hakkına sahiptir. Kataloglarda yer alan görsellerde gözükken montaj, bağlantı detayları, kullanım alanları veya güvenlik önlemleri ürünlerin doğru kullanımı için bir örnek teşkil etmez. Ürünleri kullanan kişiler, katalog içeriğinde yer alan ürünler ile ilgili güvenlik uyarılarına ve ayrıca ürünlere ilişkin ek güvenlik/kullanım talimatlarına uymakla yükümlüdür, aksi takdirde ortaya çıkacak zararlardan firma hiçbir suretle sorumlu tutulamaz.

İşbu Katalog, tüm sayfaları, içeriğindeki bilgiler ve ürünler firmanın fikri ve sınai hakları kapsamında korunmaktadır. Ürün katalogu, içeriğindeki tüm bilgiler ile görseller ve ürünlere ilişkin telif hakkı İzeltaş İzmir El Aletleri Sanayi ve Ticaret A.Ş.'ye aittir. Firmanın yazılı izni olmadan işbu telif hakkına konu ürünlerin, bilgilerin, görsellerin veya katalogun izinsiz kullanılması, yayımlanması, üretilmesi, dağıtılması ve çoğaltılması yasaktır, aksi durum firmanın fikri ve sınai hakkın ihlali sonucunu doğuracaktır.

This catalog replaces previous editions.

The technical features, appearance and dimensions of the products in the catalog represent the current conditions at the date of publication of the catalog. For this reason, we recommend that you contact the company before ordering and learn the current information about the products on the order date. The company does not have any responsibility under any name due to the fact that the technical features, appearance or size of the products specified in the catalog are not the same as the products on the order date. In line with this information, the company is not responsible in any way or form for any errors, material or moral damages that may arise from the information or visual material contained in this catalogue.

The company may make unilateral changes regarding the information or products in the catalog without prior notice. The company reserves the right to change the technical specifications, images or dimensions of its products or products, in whole or in part, at any time. The assembly, connection details, usage areas or safety measures seen in the images in the catalogs do not constitute an example for the correct use of the products. Persons using the products are obliged to comply with the safety warnings regarding the products in the catalog content, as well as the additional safety / usage instructions regarding the products, otherwise the company cannot be held responsible for any damages that may arise.

This Catalog, all its pages, the information and products in it are protected within the scope of the intellectual and industrial rights of the company. The copyright of the product catalog, all the information in its content, images and products belongs to İzeltaş İzmir El Aletleri Sanayi ve Ticaret A.Ş. Unauthorized use, publication, production, distribution and reproduction of the products, information, images or catalog subject to this copyright without the written permission of the company is prohibited, otherwise it will result in violation of the intellectual and industrial rights of the company.

(★) İşaretili olan ürünler stoklarla sınırlıdır.
Limited with stocks.

| KOD | ÜRÜN | SAYFA | | | SAYFA |
|------------|-----------------------------|-------|------------|--------------------------------|-------|
| 8245321005 | TKD ÇKM5 SYH PRM | 7 | 8244321005 | TKD ÇKM5 KRMZ SYH TRND | 24 |
| 8245321007 | TKD ÇKM7 SYH PRM | 7 | 8244321007 | TKD ÇKM7 KRMZ SYH TRND | 24 |
| 8245007096 | TKD ÇKM7 SET243 PRM | 7 | 8244005096 | TKD ÇKM5 KRMZ SET93 TRND | 24 |
| 8245001042 | TKD 1.ÇKM SET42 PRM | 8 | 8244007096 | TKD ÇKM7 KRMZ SET93 TRND | 24 |
| 8245002094 | TKD 2.ÇKM SET91 PRM | 8 | 8244001030 | TKD 1.ÇKM SET30 TRND | 25 |
| 8245003014 | TKD 3.ÇKM SET14 PRM | 8 | 8244002052 | TKD 2.ÇKM SET49 TRND | 25 |
| 8245004043 | TKD 4.ÇKM SET43 PRM | 9 | 8244003013 | TKD 3.ÇKM SET13 TRND | 25 |
| 8245005043 | TKD 5.ÇKM SET43 PRM | 9 | 8246321007 | TKD AHŞAP ÜST TBL KRMZ ANT XXL | 26 |
| 8245006009 | TKD 6.ÇKM SET9 PRM | 9 | 8247321007 | TKD AHŞAP ÜST TBL KRMZ ANT WB | 27 |
| 8241321005 | TKD ÇKM5 GRİ KRMZ PROMOB | 11 | 8210326001 | TKD VGN | 28 |
| 8241321006 | TKD ÇKM6 GRİ KRMZ PROMOB | 11 | 8160326001 | TKD | 29 |
| 8241321007 | TKD ÇKM7 GRİ KRMZ PROMOB | 11 | 8550348001 | DMNT KÇK SRV ARB | 30 |
| 8241321008 | TKD ÇKM8 GRİ KRMZ PROMOB | 11 | 8550348002 | KAPA KÇK DMNT SRV ARB | 30 |
| 8241322005 | TKD ÇKM5 GRİ MAVİ PROMOB | 11 | 8545341005 | DMNT TARB | 31 |
| 8241322006 | TKD ÇKM6 GRİ MAVİ PROMOB | 11 | 8550346001 | BYK SRV ARB | 31 |
| 8241322007 | TKD ÇKM7 GRİ MAVİ PROMOB | 11 | 8500346001 | SRVMASA P | 32 |
| 8241322008 | TKD ÇKM8 GRİ MAVİ PROMOB | 11 | 8501346001 | SRVMASA | 33 |
| 8241323005 | TKD ÇKM5 GRİ GRİ PROMOB | 11 | 8502346002 | DMNT ATLY MASA | 34 |
| 8241323006 | TKD ÇKM6 GRİ GRİ PROMOB | 11 | 8320331001 | ÇKM ALET SND KRMZ450 | 36 |
| 8241323007 | TKD ÇKM7 GRİ GRİ PROMOB | 11 | 8320331003 | ÇKM ALET SND KRMZ650 | 36 |
| 8241323008 | TKD ÇKM8 GRİ GRİ PROMOB | 11 | 8410336103 | TKÇ GÖZ3 300 | 37 |
| 8241001209 | TKD ÇKM8 KRMZ SET206 PROMOB | 11 | 8410336203 | TKÇ GÖZ3 420 | 37 |
| 8241001030 | TKD 1.ÇKM SET30 PROMOB | 12 | 8420336105 | TKÇ GÖZ5 300 | 37 |
| 8241002072 | TKD 2.ÇKM SET69 PROMOB | 12 | 8420336205 | TKÇ GÖZ5 420 | 37 |
| 8241003051 | TKD 3.ÇKM SET51 PROMOB | 12 | 8420336305 | TKÇ GÖZ5 520 | 37 |
| 8241004027 | TKD 4.ÇKM SET27 PROMOB | 13 | 8420336405 | TKÇ GÖZ5 600 | 37 |
| 8241005010 | TKD 5.ÇKM SET10 PROMOB | 13 | 8420005063 | TKÇ GÖZ5 420 MNKN SET62 | 39 |
| 8241006018 | TKD 6.ÇKM SET18 PROMOB | 13 | 8420005046 | TKÇ GÖZ5 420 ELKT SET45 | 39 |
| 8242321005 | TKD ÇKM5 KRMZ GRİ GRJ | 15 | 8420005028 | TKÇ GÖZ5 420 TSTÇ SET28 | 39 |
| 8242321006 | TKD ÇKM6 KRMZ GRİ GRJ | 15 | 8440331016 | TKÇ PLS 16" | 40 |
| 8242321007 | TKD ÇKM7 KRMZ GRİ GRJ | 15 | 8440331019 | TKÇ PLS 19" | 40 |
| 8242321008 | TKD ÇKM8 KRMZ GRİ GRJ | 15 | 8440331022 | TKÇ PLS 22" | 40 |
| 8242322005 | TKD ÇKM5 MAVİ GRİ GRJ | 15 | 8445331028 | TKÇ PLS TKR 28" | 40 |
| 8242322006 | TKD ÇKM6 MAVİ GRİ GRJ | 15 | 8705006113 | OTO TİP HOB SET13 | 40 |
| 8242322007 | TKD ÇKM7 MAVİ GRİ GRJ | 15 | 8790008106 | BKM ONRM SET5 | 40 |
| 8242322008 | TKD ÇKM8 MAVİ GRİ GRJ | 15 | 8793001014 | BKM SET14 | 41 |
| 8242323005 | TKD ÇKM5 GRİ GRİ GRJ | 15 | 8786001003 | DĞD SET3 | 41 |
| 8242323006 | TKD ÇKM6 GRİ GRİ GRJ | 15 | 8779008741 | MOTOSİKLET BKM SET42 | 41 |
| 8242323007 | TKD ÇKM7 GRİ GRİ GRJ | 15 | 100010405 | 2A ANH KB 0405 | 45 |
| 8242323008 | TKD ÇKM8 GRİ GRİ GRJ | 15 | 100010607 | 2A ANH KB 0607 | 45 |
| 8242001142 | TKD ÇKM7 KRMZ SET139 GRJ | 15 | 100010809 | 2A ANH KB 0809 | 45 |
| 8242008142 | TKD ÇKM8 KRMZ SET139 GRJ | 15 | 100010810 | 2A ANH KB 0810 | 45 |
| 8242001030 | TKD 1.ÇKM SET30 GRJ | 16 | 100011011 | 2A ANH KB 1011 | 45 |
| 8242002072 | TKD 2.ÇKM SET69 GRJ | 16 | 100011012 | 2A ANH KB 1012 | 45 |
| 8242003010 | TKD 3.ÇKM SET10 GRJ | 17 | 100011013 | 2A ANH KB 1013 | 45 |
| 8242004018 | TKD 4.ÇKM SET18 GRJ | 17 | 100011213 | 2A ANH KB 1213 | 45 |
| 8242005011 | TKD 5.ÇKM SET11 GRJ | 17 | 100011214 | 2A ANH KB 1214 | 45 |
| 8235326005 | TKD ÇKM5 KRMZ PART | 19 | 100011314 | 2A ANH KB 1314 | 45 |
| 8235325005 | TKD ÇKM5 MAVİ PART | 19 | 100011415 | 2A ANH KB 1415 | 45 |
| 8235327005 | TKD ÇKM5 SYH PART | 19 | 100011317 | 2A ANH KB 1317 | 45 |
| 8235006121 | TKD ÇKM5 KRMZ SET118 PART | 19 | 100011417 | 2A ANH KB 1417 | 45 |
| 8235001072 | TKD 1.ÇKM SET69 PART | 20 | 100011617 | 2A ANH KB 1617 | 45 |
| 8235002031 | TKD 2.ÇKM SET31 PART | 21 | 100011719 | 2A ANH KB 1719 | 45 |
| 8235003017 | TKD 3.ÇKM SET17 PART | 21 | 100011819 | 2A ANH KB 1819 | 45 |
| 8243321003 | TKD ÇKM3 KRMZ GRİ ECO | 22 | 100011922 | 2A ANH KB 1922 | 45 |
| 8243321005 | TKD ÇKM5 KRMZ GRİ ECO | 22 | 100012022 | 2A ANH KB 2022 | 45 |
| 8243321007 | TKD ÇKM7 KRMZ GRİ ECO | 22 | 100012123 | 2A ANH KB 2123 | 45 |
| 8243322005 | TKD ÇKM5 MAVİ GRİ ECO | 22 | 100012224 | 2A ANH KB 2224 | 45 |
| 8243322007 | TKD ÇKM7 MAVİ GRİ ECO | 22 | 100012426 | 2A ANH KB 2426 | 45 |
| 8243323005 | TKD ÇKM5 GRİ GRİ ECO | 22 | 100012427 | 2A ANH KB 2427 | 45 |
| 8243323007 | TKD ÇKM7 GRİ GRİ ECO | 22 | 100012528 | 2A ANH KB 2528 | 45 |
| 8243001096 | TKD ÇKM5 KRMZ SET93 ECO | 22 | 100012732 | 2A ANH KB 2732 | 45 |
| 8243007096 | TKD ÇKM7 KRMZ SET93 ECO | 22 | 100013032 | 2A ANH KB 3032 | 45 |
| 8243001030 | TKD 1.ÇKM SET30 ECO | 23 | 100010608 | 2A ANH KB 0608 | 45 |
| 8243002052 | TKD 2.ÇKM SET49 ECO | 23 | 100010708 | 2A ANH KB 0708 | 45 |
| 8243003013 | TKD 3.ÇKM SET13 ECO | 23 | 100010709 | 2A ANH KB 0709 | 45 |
| | | | 100010910 | 2A ANH KB 0910 | 45 |

| KOD | ÜRÜN | FİYAT | SAYFA | KOD | ÜRÜN | FİYAT | SAYFA |
|-----------|--------------------------|-------|-------|-----------|----------------------------|-------|-------|
| 10001113 | 2A ANH KB 1113 | | 45 | 161010811 | 2A ANH UB 5/16X7/16 SAE | | 47 |
| 10001114 | 2A ANH KB 1114 | | 45 | 161010911 | 2A ANH UB 3/8X7/16 SAE | | 47 |
| 100011315 | 2A ANH KB 1315 | | 45 | 161011112 | 2A ANH UB 7/16X1/2 SAE | | 47 |
| 100011722 | 2A ANH KB 1722 | | 45 | 161011214 | 2A ANH UB 1/2X9/16 SAE | | 47 |
| 100011820 | 2A ANH KB 1820 | | 45 | 161011416 | 2A ANH UB 9/16X5/8 SAE | | 47 |
| 100011822 | 2A ANH KB 1822 | | 45 | 161011417 | 2A ANH UB 9/16X11/16 SAE | | 47 |
| 100011924 | 2A ANH KB 1924 | | 45 | 161011517 | 2A ANH UB 19/32X11/16 SAE | | 47 |
| 100012226 | 2A ANH KB 2226 | | 45 | 161011619 | 2A ANH UB 5/8X3/4 SAE | | 47 |
| 100012227 | 2A ANH KB 2227 | | 45 | 161011920 | 2A ANH UB 3/4X25/32 SAE | | 47 |
| 100012430 | 2A ANH KB 2430 | | 45 | 161012021 | 2A ANH UB 25/32X13/16 SAE | | 47 |
| 100012730 | 2A ANH KB 2730 | | 45 | 161011922 | 2A ANH UB 3/4X7/8 SAE | | 47 |
| 100002108 | 2A ANH KB TK8 | | 45 | 161012122 | 2A ANH UB 13/16X7/8 SAE | | 47 |
| 100002112 | 2A ANH KB TK12 | | 45 | 161012325 | 2A ANH UB 15/16X1 SAE | | 47 |
| 130010607 | 2A ANH UB 0607 | | 46 | 161012328 | 2A ANH UB 15/16X1-1/8 SAE | | 47 |
| 130010608 | 2A ANH UB 0608 | | 46 | 161012628 | 2A ANH UB 1-1/16X1-1/8 SAE | | 47 |
| 130010809 | 2A ANH UB 0809 | | 46 | 161012631 | 2A ANH UB 1-1/16X1-1/4 SAE | | 47 |
| 130010810 | 2A ANH UB 0810 | | 46 | 161012833 | 2A ANH UB 1-1/8X1-5/16 SAE | | 47 |
| 130011011 | 2A ANH UB 1011 | | 46 | 161002108 | 2A ANH UB TK8 SAE | | 47 |
| 130011012 | 2A ANH UB 1012 | | 46 | 161002112 | 2A ANH UB TK12 SAE | | 47 |
| 130011013 | 2A ANH UB 1013 | | 46 | 250010030 | 1A TAÇ ANH 30 | | 48 |
| 130011014 | 2A ANH UB 1014 | | 46 | 250010036 | 1A TAÇ ANH 36 | | 48 |
| 130011113 | 2A ANH UB 1113 | | 46 | 250010041 | 1A TAÇ ANH 41 | | 48 |
| 130011114 | 2A ANH UB 1114 | | 46 | 250010046 | 1A TAÇ ANH 46 | | 48 |
| 130011213 | 2A ANH UB 1213 | | 46 | 250010050 | 1A TAÇ ANH 50 | | 48 |
| 130011214 | 2A ANH UB 1214 | | 46 | 250010055 | 1A TAÇ ANH 55 | | 48 |
| 130011314 | 2A ANH UB 1314 | | 46 | 250010060 | 1A TAÇ ANH 60 | | 48 |
| 130011315 | 2A ANH UB 1315 | | 46 | 250010065 | 1A TAÇ ANH 65 | | 48 |
| 130011415 | 2A ANH UB 1415 | | 46 | 250010021 | 1A TAÇ ANH 21 | | 48 |
| 130011317 | 2A ANH UB 1317 | | 46 | 250010022 | 1A TAÇ ANH 22 | | 48 |
| 130011417 | 2A ANH UB 1417 | | 46 | 250010023 | 1A TAÇ ANH 23 | | 48 |
| 130011617 | 2A ANH UB 1617 | | 46 | 250010024 | 1A TAÇ ANH 24 | | 48 |
| 130011618 | 2A ANH UB 1618 | | 46 | 250010025 | 1A TAÇ ANH 25 | | 48 |
| 130011719 | 2A ANH UB 1719 | | 46 | 250010027 | 1A TAÇ ANH 27 | | 48 |
| 130011819 | 2A ANH UB 1819 | | 46 | 250010032 | 1A TAÇ ANH 32 | | 48 |
| 130011921 | 2A ANH UB 1921 | | 46 | 250010034 | 1A TAÇ ANH 34 | | 48 |
| 130011922 | 2A ANH UB 1922 | | 46 | 250010038 | 1A TAÇ ANH 38 | | 48 |
| 130012022 | 2A ANH UB 2022 | | 46 | 250010070 | 1A TAÇ ANH 70 | | 48 |
| 130011924 | 2A ANH UB 1924 | | 46 | 250010075 | 1A TAÇ ANH 75 | | 48 |
| 130012123 | 2A ANH UB 2123 | | 46 | 325020010 | MNT ANH 10 | | 48 |
| 130012224 | 2A ANH UB 2224 | | 46 | 325020013 | MNT ANH 13 | | 48 |
| 130012426 | 2A ANH UB 2426 | | 46 | 325020017 | MNT ANH 17 | | 48 |
| 130012427 | 2A ANH UB 2427 | | 46 | 325020019 | MNT ANH 19 | | 48 |
| 130012430 | 2A ANH UB 2430 | | 46 | 325020020 | MNT ANH 20 | | 48 |
| 130012528 | 2A ANH UB 2528 | | 46 | 325020021 | MNT ANH 21 | | 48 |
| 130012729 | 2A ANH UB 2729 | | 46 | 325020022 | MNT ANH 22 | | 48 |
| 130012730 | 2A ANH UB 2730 | | 46 | 255010010 | 1A SPR İZL ANH 10 | | 48 |
| 130012732 | 2A ANH UB 2732 | | 46 | 255010011 | 1A SPR İZL ANH 11 | | 48 |
| 130013032 | 2A ANH UB 3032 | | 46 | 255010012 | 1A SPR İZL ANH 12 | | 48 |
| 130013036 | 2A ANH UB 3036 | | 46 | 255010013 | 1A SPR İZL ANH 13 | | 48 |
| 130013236 | 2A ANH UB 3236 | | 46 | 255010014 | 1A SPR İZL ANH 14 | | 48 |
| 130013436 | 2A ANH UB 3436 | | 46 | 255010017 | 1A SPR İZL ANH 17 | | 48 |
| 130013641 | 2A ANH UB 3641 | | 46 | 255010019 | 1A SPR İZL ANH 19 | | 48 |
| 130014146 | 2A ANH UB 4146 | | 46 | 255010022 | 1A SPR İZL ANH 22 | | 48 |
| 130014650 | 2A ANH UB 4650 | | 46 | 255010024 | 1A SPR İZL ANH 24 | | 48 |
| 130010555 | 2A ANH UB 05X5,5 | | 46 | 320020005 | KMB ANH KB 05 | | 49 |
| 130010708 | 2A ANH UB 0708 | | 46 | 320020055 | KMB ANH KB 5,5 | | 49 |
| 130010709 | 2A ANH UB 0709 | | 46 | 320020006 | KMB ANH KB 06 | | 49 |
| 130010910 | 2A ANH UB 0910 | | 46 | 320020007 | KMB ANH KB 07 | | 49 |
| 130010911 | 2A ANH UB 0911 | | 46 | 320020008 | KMB ANH KB 08 | | 49 |
| 130011722 | 2A ANH UB 1722 | | 46 | 320020009 | KMB ANH KB 09 | | 49 |
| 130011724 | 2A ANH UB 1724 | | 46 | 320020010 | KMB ANH KB 10 | | 49 |
| 130012227 | 2A ANH UB 2227 | | 46 | 320020011 | KMB ANH KB 11 | | 49 |
| 130002108 | 2A ANH UB TK8 | | 46 | 320020012 | KMB ANH KB 12 | | 49 |
| 130002112 | 2A ANH UB TK12 | | 46 | 320020013 | KMB ANH KB 13 | | 49 |
| 161010608 | 2A ANH UB 1/4X5/16 SAE | | 47 | 320020014 | KMB ANH KB 14 | | 49 |
| 161010809 | 2A ANH UB 5/16X3/8 SAE | | 47 | 320020015 | KMB ANH KB 15 | | 49 |
| 161010810 | 2A ANH UB 5/16X11/32 SAE | | 47 | 320020016 | KMB ANH KB 16 | | 49 |

| KOD | ÜRÜN | FİYAT | SAYFA | KOD | ÜRÜN | FİYAT | SAYFA |
|-----------|----------------------|-------|-------|-----------|-----------------------------|-------|-------|
| 320020017 | KMB ANH KB 17 | | 49 | 331020017 | KMB ANH UB 11/16 SAE | | 51 |
| 320020018 | KMB ANH KB 18 | | 49 | 331020019 | KMB ANH UB 3/4 SAE | | 51 |
| 320020019 | KMB ANH KB 19 | | 49 | 331020020 | KMB ANH UB 25/32 SAE | | 51 |
| 320020020 | KMB ANH KB 20 | | 49 | 331020021 | KMB ANH UB 13/16 SAE | | 51 |
| 320020021 | KMB ANH KB 21 | | 49 | 331020022 | KMB ANH UB 7/8 SAE | | 51 |
| 320020022 | KMB ANH KB 22 | | 49 | 331020024 | KMB ANH UB 15/16 SAE | | 51 |
| 320020023 | KMB ANH KB 23 | | 49 | 331020025 | KMB ANH UB 1 SAE | | 51 |
| 320020024 | KMB ANH KB 24 | | 49 | 331020027 | KMB ANH UB 1-1/16 SAE | | 51 |
| 320020025 | KMB ANH KB 25 | | 49 | 331020028 | KMB ANH UB 1-1/8 SAE | | 51 |
| 320020026 | KMB ANH KB 26 | | 49 | 331020030 | KMB ANH UB 1-3/16 SAE | | 51 |
| 320020027 | KMB ANH KB 27 | | 49 | 331020032 | KMB ANH UB 1-1/4 SAE | | 51 |
| 320020028 | KMB ANH KB 28 | | 49 | 331020033 | KMB ANH UB 1-5/16 SAE | | 51 |
| 320020029 | KMB ANH KB 29 | | 49 | 331020038 | KMB ANH UB 1-1/2 SAE | | 51 |
| 320020030 | KMB ANH KB 30 | | 49 | 331020035 | KMB ANH UB 1-3/8 SAE | | 51 |
| 320020032 | KMB ANH KB 32 | | 49 | 331020036 | KMB ANH UB 1-7/16 SAE | | 51 |
| 320020034 | KMB ANH KB 34 | | 49 | 331020041 | KMB ANH UB 1-5/8 SAE | | 51 |
| 320002108 | KMB ANH KB TK8 | | 49 | 331020046 | KMB ANH UB 1-13/16 SAE | | 51 |
| 320002112 | KMB ANH KB TK12 | | 49 | 331020050 | KMB ANH UB 2 SAE | | 51 |
| 320002117 | KMB ANH KB TK17 | | 49 | 331002108 | KMB ANH UB TK8 SAE | | 51 |
| 320002121 | KMB ANH KB TK21 | | 49 | 331002112 | KMB ANH UB TK12 SAE | | 51 |
| 330020005 | KMB ANH UB 05 | | 50 | 331002117 | KMB ANH UB TK17 SAE | | 51 |
| 330020055 | KMB ANH UB 5,5 | | 50 | 331002120 | KMB ANH UB TK20 SAE | | 51 |
| 330020006 | KMB ANH UB 06 | | 50 | 340020008 | CRC KMB ANH 08 | | 52 |
| 330020007 | KMB ANH UB 07 | | 50 | 340020009 | CRC KMB ANH 09 | | 52 |
| 330020008 | KMB ANH UB 08 | | 50 | 340020010 | CRC KMB ANH 10 | | 52 |
| 330020009 | KMB ANH UB 09 | | 50 | 340020011 | CRC KMB ANH 11 | | 52 |
| 330020010 | KMB ANH UB 10 | | 50 | 340020012 | CRC KMB ANH 12 | | 52 |
| 330020011 | KMB ANH UB 11 | | 50 | 340020013 | CRC KMB ANH 13 | | 52 |
| 330020012 | KMB ANH UB 12 | | 50 | 340020014 | CRC KMB ANH 14 | | 52 |
| 330020013 | KMB ANH UB 13 | | 50 | 340020015 | CRC KMB ANH 15 | | 52 |
| 330020014 | KMB ANH UB 14 | | 50 | 340020016 | CRC KMB ANH 16 | | 52 |
| 330020015 | KMB ANH UB 15 | | 50 | 340020017 | CRC KMB ANH 17 | | 52 |
| 330020016 | KMB ANH UB 16 | | 50 | 340020018 | CRC KMB ANH 18 | | 52 |
| 330020017 | KMB ANH UB 17 | | 50 | 340020019 | CRC KMB ANH 19 | | 52 |
| 330020018 | KMB ANH UB 18 | | 50 | 340020021 | CRC KMB ANH 21 | | 52 |
| 330020019 | KMB ANH UB 19 | | 50 | 340020022 | CRC KMB ANH 22 | | 52 |
| 330020020 | KMB ANH UB 20 | | 50 | 340020024 | CRC KMB ANH 24 | | 52 |
| 330020021 | KMB ANH UB 21 | | 50 | 335020010 | ÇOK YLD CRC ANH 10X13X17X19 | | 52 |
| 330020022 | KMB ANH UB 22 | | 50 | 340002110 | CRC KMB ANH TK10 | | 52 |
| 330020023 | KMB ANH UB 23 | | 50 | 340002115 | CRC KMB ANH TK15 | | 52 |
| 330020024 | KMB ANH UB 24 | | 50 | 345020008 | MFSL CRC KMB ANH 08 | | 53 |
| 330020025 | KMB ANH UB 25 | | 50 | 345020009 | MFSL CRC KMB ANH 09 | | 53 |
| 330020026 | KMB ANH UB 26 | | 50 | 345020010 | MFSL CRC KMB ANH 10 | | 53 |
| 330020027 | KMB ANH UB 27 | | 50 | 345020011 | MFSL CRC KMB ANH 11 | | 53 |
| 330020028 | KMB ANH UB 28 | | 50 | 345020012 | MFSL CRC KMB ANH 12 | | 53 |
| 330020029 | KMB ANH UB 29 | | 50 | 345020013 | MFSL CRC KMB ANH 13 | | 53 |
| 330020030 | KMB ANH UB 30 | | 50 | 345020014 | MFSL CRC KMB ANH 14 | | 53 |
| 330020032 | KMB ANH UB 32 | | 50 | 345020015 | MFSL CRC KMB ANH 15 | | 53 |
| 330020034 | KMB ANH UB 34 | | 50 | 345020016 | MFSL CRC KMB ANH 16 | | 53 |
| 330020036 | KMB ANH UB 36 | | 50 | 345020017 | MFSL CRC KMB ANH 17 | | 53 |
| 330020038 | KMB ANH UB 38 | | 50 | 345020018 | MFSL CRC KMB ANH 18 | | 53 |
| 330020041 | KMB ANH UB 41 | | 50 | 345020019 | MFSL CRC KMB ANH 19 | | 53 |
| 330020046 | KMB ANH UB 46 | | 50 | 345002112 | MFSL CRC KMB ANH TK12 | | 53 |
| 330020050 | KMB ANH UB 50 | | 50 | 370020006 | BYN KMB ANH 06 | | 54 |
| 330002108 | KMB ANH UB TK8 | | 50 | 370020007 | BYN KMB ANH 07 | | 54 |
| 330002112 | KMB ANH UB TK12 | | 50 | 370020008 | BYN KMB ANH 08 | | 54 |
| 330002117 | KMB ANH UB TK17 | | 50 | 370020009 | BYN KMB ANH 09 | | 54 |
| 330002121 | KMB ANH UB TK21 | | 50 | 370020010 | BYN KMB ANH 10 | | 54 |
| 331020005 | KMB ANH UB 3/16 SAE | | 51 | 370020011 | BYN KMB ANH 11 | | 54 |
| 331020006 | KMB ANH UB 1/4 SAE | | 51 | 370020012 | BYN KMB ANH 12 | | 54 |
| 331020008 | KMB ANH UB 5/16 SAE | | 51 | 370020013 | BYN KMB ANH 13 | | 54 |
| 331020010 | KMB ANH UB 3/8 SAE | | 51 | 370020014 | BYN KMB ANH 14 | | 54 |
| 331020011 | KMB ANH UB 7/16 SAE | | 51 | 370020015 | BYN KMB ANH 15 | | 54 |
| 331020013 | KMB ANH UB 1/2 SAE | | 51 | 370020016 | BYN KMB ANH 16 | | 54 |
| 331020014 | KMB ANH UB 9/16 SAE | | 51 | 370020017 | BYN KMB ANH 17 | | 54 |
| 331020015 | KMB ANH UB 19/32 SAE | | 51 | 370020018 | BYN KMB ANH 18 | | 54 |
| 331020016 | KMB ANH UB 5/8 SAE | | 51 | 370020019 | BYN KMB ANH 19 | | 54 |

| KOD | ÜRÜN | FİYAT | SAYFA | KOD | ÜRÜN | FİYAT | SAYFA |
|-----------|--------------------|-------|-------|-----------|---------------------------------|-------|-------|
| 370020020 | BYN KMB ANH 20 | | 54 | 430031315 | 2A YLD ANH SB 1315 | | 56 |
| 370020021 | BYN KMB ANH 21 | | 54 | 430032227 | 2A YLD ANH SB 2227 | | 56 |
| 370020022 | BYN KMB ANH 22 | | 54 | 430033034 | 2A YLD ANH SB 3034 | | 56 |
| 370020023 | BYN KMB ANH 23 | | 54 | 430002108 | 2A YLD ANH SB TK8 | | 56 |
| 370020024 | BYN KMB ANH 24 | | 54 | 430002112 | 2A YLD ANH SB TK12 | | 56 |
| 370020025 | BYN KMB ANH 25 | | 54 | 431030608 | 2A YLD ANH SB 1/4X5/16 SAE | | 57 |
| 370020026 | BYN KMB ANH 26 | | 54 | 431030809 | 2A YLD ANH SB 5/16X3/8 SAE | | 57 |
| 370020027 | BYN KMB ANH 27 | | 54 | 431030811 | 2A YLD ANH SB 5/16X7/16 SAE | | 57 |
| 370020028 | BYN KMB ANH 28 | | 54 | 431030911 | 2A YLD ANH SB 3/8X7/16 SAE | | 57 |
| 370020029 | BYN KMB ANH 29 | | 54 | 431031112 | 2A YLD ANH SB 7/16X1/2 SAE | | 57 |
| 370020030 | BYN KMB ANH 30 | | 54 | 431031214 | 2A YLD ANH SB 1/2X9/16 SAE | | 57 |
| 370020032 | BYN KMB ANH 32 | | 54 | 431031415 | 2A YLD ANH SB 9/16X19/32 SAE | | 57 |
| 370020036 | BYN KMB ANH 36 | | 54 | 431031416 | 2A YLD ANH SB 9/16X5/8 SAE | | 57 |
| 370002108 | BYN KMB ANH TK8 | | 54 | 431031517 | 2A YLD ANH SB 19/32X11/16 SAE | | 57 |
| 370002112 | BYN KMB ANH TK12 | | 54 | 431031920 | 2A YLD ANH SB 3/4X25/32 SAE | | 57 |
| 370002117 | BYN KMB ANH TK17 | | 54 | 431032122 | 2A YLD ANH SB 13/16X7/8 SAE | | 57 |
| 370002121 | BYN KMB ANH TK21 | | 54 | 431032325 | 2A YLD ANH SB 15/16X1 SAE | | 57 |
| 380020008 | TORX KMB ANH 08 | | 55 | 431032631 | 2A YLD ANH SB 1-1/16X1-1/4 SAE | | 57 |
| 380020009 | TORX KMB ANH 09 | | 55 | 431032833 | 2A YLD ANH SB 1-1/8X1-5/16 SAE | | 57 |
| 380020010 | TORX KMB ANH 10 | | 55 | 431033033 | 2A YLD ANH SB 1-3/16X1-5/16 SAE | | 57 |
| 380020011 | TORX KMB ANH 11 | | 55 | 431031217 | 2A YLD ANH SB 1/2X11/16 SAE | | 57 |
| 380020012 | TORX KMB ANH 12 | | 55 | 431031417 | 2A YLD ANH SB 9/16x11/16 SAE | | 57 |
| 380020013 | TORX KMB ANH 13 | | 55 | 431031617 | 2A YLD ANH SB 5/8X11/16 SAE | | 57 |
| 380020014 | TORX KMB ANH 14 | | 55 | 431031619 | 2A YLD ANH SB 5/8X3/4 SAE | | 57 |
| 380020015 | TORX KMB ANH 15 | | 55 | 431032021 | 2A YLD ANH SB 25/32X13/16 SAE | | 57 |
| 380020017 | TORX KMB ANH 17 | | 55 | 431031922 | 2A YLD ANH SB 3/4X7/8 SAE | | 57 |
| 380020018 | TORX KMB ANH 18 | | 55 | 431032223 | 2A YLD ANH SB 7/8X15/16 SAE | | 57 |
| 380020019 | TORX KMB ANH 19 | | 55 | 431032328 | 2A YLD ANH SB 15/16x1-1/8 SAE | | 57 |
| 380020022 | TORX KMB ANH 22 | | 55 | 431032528 | 2A YLD ANH SB 1X1-1/8 SAE | | 57 |
| 38002108 | TORX KMB ANH TK8 | | 55 | 431033036 | 2A YLD ANH SB 1-3/16 X1-3/8 SAE | | 57 |
| 38002112 | TORX KMB ANH TK12 | | 55 | 431033236 | 2A YLD ANH SB 1-1/4X1-7/16 SAE | | 57 |
| 430030607 | 2A YLD ANH SB 0607 | | 56 | 431033641 | 2A YLD ANH SB 1-7/16X1-5/8 SAE | | 57 |
| 430030809 | 2A YLD ANH SB 0809 | | 56 | 431034146 | 2A YLD ANH SB 1-11/16X1-7/8 SAE | | 57 |
| 430030810 | 2A YLD ANH SB 0810 | | 56 | 431034650 | 2A YLD ANH SB 1-13/16X2 SAE | | 57 |
| 430031011 | 2A YLD ANH SB 1011 | | 56 | 431002108 | 2A YLD ANH SB TK8 SAE | | 57 |
| 430031012 | 2A YLD ANH SB 1012 | | 56 | 431002112 | 2A YLD ANH SB TK12 SAE | | 57 |
| 430031013 | 2A YLD ANH SB 1013 | | 56 | 440030607 | 2A DÜZ YLD ANH SB 0607 | | 58 |
| 430031113 | 2A YLD ANH SB 1113 | | 56 | 440030809 | 2A DÜZ YLD ANH SB 0809 | | 58 |
| 430031213 | 2A YLD ANH SB 1213 | | 56 | 440031011 | 2A DÜZ YLD ANH SB 1011 | | 58 |
| 430031214 | 2A YLD ANH SB 1214 | | 56 | 440031213 | 2A DÜZ YLD ANH SB 1213 | | 58 |
| 430031415 | 2A YLD ANH SB 1415 | | 56 | 440031415 | 2A DÜZ YLD ANH SB 1415 | | 58 |
| 430031317 | 2A YLD ANH SB 1317 | | 56 | 440031617 | 2A DÜZ YLD ANH SB 1617 | | 58 |
| 430031417 | 2A YLD ANH SB 1417 | | 56 | 440031819 | 2A DÜZ YLD ANH SB 1819 | | 58 |
| 430031617 | 2A YLD ANH SB 1617 | | 56 | 440032022 | 2A DÜZ YLD ANH SB 2022 | | 58 |
| 430031618 | 2A YLD ANH SB 1618 | | 56 | 440032123 | 2A DÜZ YLD ANH SB 2123 | | 58 |
| 430031719 | 2A YLD ANH SB 1719 | | 56 | 440032426 | 2A DÜZ YLD ANH SB 2426 | | 58 |
| 430031819 | 2A YLD ANH SB 1819 | | 56 | 440032528 | 2A DÜZ YLD ANH SB 2528 | | 58 |
| 430031922 | 2A YLD ANH SB 1922 | | 56 | 440032732 | 2A DÜZ YLD ANH SB 2732 | | 58 |
| 430031924 | 2A YLD ANH SB 1924 | | 56 | 440030810 | 2A DÜZ YLD ANH SB 0810 | | 58 |
| 430032022 | 2A YLD ANH SB 2022 | | 56 | 440031013 | 2A DÜZ YLD ANH SB 1013 | | 58 |
| 430032123 | 2A YLD ANH SB 2123 | | 56 | 440031315 | 2A DÜZ YLD ANH SB 1315 | | 58 |
| 430032224 | 2A YLD ANH SB 2224 | | 56 | 440031317 | 2A DÜZ YLD ANH SB 1317 | | 58 |
| 430032426 | 2A YLD ANH SB 2426 | | 56 | 440031618 | 2A DÜZ YLD ANH SB 1618 | | 58 |
| 430032427 | 2A YLD ANH SB 2427 | | 56 | 440031719 | 2A DÜZ YLD ANH SB 1719 | | 58 |
| 430032430 | 2A YLD ANH SB 2430 | | 56 | 440032224 | 2A DÜZ YLD ANH SB 2224 | | 58 |
| 430032528 | 2A YLD ANH SB 2528 | | 56 | 440032427 | 2A DÜZ YLD ANH SB 2427 | | 58 |
| 430032729 | 2A YLD ANH SB 2729 | | 56 | 440032729 | 2A DÜZ YLD ANH SB 2729 | | 58 |
| 430032730 | 2A YLD ANH SB 2730 | | 56 | 440033032 | 2A DÜZ YLD ANH SB 3032 | | 58 |
| 430032732 | 2A YLD ANH SB 2732 | | 56 | 440002108 | 2A DÜZ YLD ANH SB TK8 | | 58 |
| 430033032 | 2A YLD ANH SB 3032 | | 56 | 440002112 | 2A DÜZ YLD ANH SB TK12 | | 58 |
| 430033036 | 2A YLD ANH SB 3036 | | 56 | 435030010 | 1A SPR İZL YLD ANH SB 10 | | 59 |
| 430033236 | 2A YLD ANH SB 3236 | | 56 | 435030011 | 1A SPR İZL YLD ANH SB 11 | | 59 |
| 430033436 | 2A YLD ANH SB 3436 | | 56 | 435030012 | 1A SPR İZL YLD ANH SB 12 | | 59 |
| 430033641 | 2A YLD ANH SB 3641 | | 56 | 435030013 | 1A SPR İZL YLD ANH SB 13 | | 59 |
| 430034146 | 2A YLD ANH SB 4146 | | 56 | 435030014 | 1A SPR İZL YLD ANH SB 14 | | 59 |
| 430034650 | 2A YLD ANH SB 4650 | | 56 | 435030017 | 1A SPR İZL YLD ANH SB 17 | | 59 |
| 430031014 | 2A YLD ANH SB 1014 | | 56 | 435030019 | 1A SPR İZL YLD ANH SB 19 | | 59 |

| KOD | ÜRÜN | FİYAT | SAYFA | KOD | ÜRÜN | FİYAT | SAYFA |
|-----------|-------------------------------|-------|-------|------------|------------------------|-------|-------|
| 435030022 | 1A SPR IZL YLD ANH SB 22 | | 59 | 750050055 | YLD ÇAK ANH 55 | | 60 |
| 435030024 | 1A SPR IZL YLD ANH SB 24 | | 59 | 750050060 | YLD ÇAK ANH 60 | | 60 |
| 540010810 | 2A RKR ANH 0810 | | 59 | 750050065 | YLD ÇAK ANH 65 | | 60 |
| 540011011 | 2A RKR ANH 1011 | | 59 | 750050070 | YLD ÇAK ANH 70 | | 60 |
| 540011012 | 2A RKR ANH 1012 | | 59 | 750050075 | YLD ÇAK ANH 75 | | 60 |
| 540011113 | 2A RKR ANH 1113 | | 59 | 750050080 | YLD ÇAK ANH 80 | | 60 |
| 540011214 | 2A RKR ANH 1214 | | 59 | 750050085 | YLD ÇAK ANH 85 | | 60 |
| 540011719 | 2A RKR ANH 1719 | | 59 | 750050090 | YLD ÇAK ANH 90 | | 60 |
| 540011922 | 2A RKR ANH 1922 | | 59 | 750050095 | YLD ÇAK ANH 95 | | 60 |
| 530040810 | YRM AY YLD ANH 0810 | | 59 | 750050100 | YLD ÇAK ANH 100 | | 60 |
| 530041011 | YRM AY YLD ANH 1011 | | 59 | 750050105 | YLD ÇAK ANH 105 | | 60 |
| 530041012 | YRM AY YLD ANH 1012 | | 59 | 750050110 | YLD ÇAK ANH 110 | | 60 |
| 530041113 | YRM AY YLD ANH 1113 | | 59 | 750050115 | YLD ÇAK ANH 115 | | 60 |
| 530041315 | YRM AY YLD ANH 1315 | | 59 | 750050120 | YLD ÇAK ANH 120 | | 60 |
| 530041317 | YRM AY YLD ANH 1317 | | 59 | 750050125 | YLD ÇAK ANH 125 | | 60 |
| 530041417 | YRM AY YLD ANH 1417 | | 59 | 750050130 | YLD ÇAK ANH 130 | | 60 |
| 530041517 | YRM AY YLD ANH 1517 | | 59 | 750050135 | YLD ÇAK ANH 135 | | 60 |
| 530041922 | YRM AY YLD ANH 1922 | | 59 | 750050140 | YLD ÇAK ANH 140 | | 60 |
| 531041112 | YRM AY YLD ANH 7/16X1/2 SAE | | 59 | 750050145 | YLD ÇAK ANH 145 | | 60 |
| 531041214 | YRM AY YLD ANH 1/2X9/16 SAE | | 59 | 750050150 | YLD ÇAK ANH 150 | | 60 |
| 531041416 | YRM AY YLD ANH 9/16X5/8 SAE | | 59 | 750050155 | YLD ÇAK ANH 155 | | 60 |
| 531041922 | YRM AY YLD ANH 3/4X7/8 SAE | | 59 | 750050160 | YLD ÇAK ANH 160 | | 60 |
| 531040809 | YRM AY YLD ANH 5/16X3/8 SAE | | 59 | 750050165 | YLD ÇAK ANH 165 | | 60 |
| 531040911 | YRM AY YLD ANH 3/8X7/16 SAE | | 59 | 750050170 | YLD ÇAK ANH 170 | | 60 |
| 531041417 | YRM AY YLD ANH 9/16X11/16 SAE | | 59 | 750050180 | YLD ÇAK ANH 180 | | 60 |
| 700050024 | ÇTL ÇAK ANH 24 | | 60 | 550050024 | BORU UZT YLD ANH 24 | | 61 |
| 700050027 | ÇTL ÇAK ANH 27 | | 60 | 550050027 | BORU UZT YLD ANH 27 | | 61 |
| 700050030 | ÇTL ÇAK ANH 30 | | 60 | 550050030 | BORU UZT YLD ANH 30 | | 61 |
| 700050032 | ÇTL ÇAK ANH 32 | | 60 | 550050032 | BORU UZT YLD ANH 32 | | 61 |
| 700050036 | ÇTL ÇAK ANH 36 | | 60 | 550050036 | BORU UZT YLD ANH 36 | | 61 |
| 700050038 | ÇTL ÇAK ANH 38 | | 60 | 550050038 | BORU UZT YLD ANH 38 | | 61 |
| 700050041 | ÇTL ÇAK ANH 41 | | 60 | 550050041 | BORU UZT YLD ANH 41 | | 61 |
| 700050042 | ÇTL ÇAK ANH 42 | | 60 | 550050046 | BORU UZT YLD ANH 46 | | 61 |
| 700050046 | ÇTL ÇAK ANH 46 | | 60 | 550050050 | BORU UZT YLD ANH 50 | | 61 |
| 700050047 | ÇTL ÇAK ANH 47 | | 60 | 550050055 | BORU UZT YLD ANH 55 | | 61 |
| 700050050 | ÇTL ÇAK ANH 50 | | 60 | 550050060 | BORU UZT YLD ANH 60 | | 61 |
| 700050055 | ÇTL ÇAK ANH 55 | | 60 | 550050065 | BORU UZT YLD ANH 65 | | 61 |
| 700050060 | ÇTL ÇAK ANH 60 | | 60 | 550050022 | BORU UZT YLD ANH 22 | | 61 |
| 700050065 | ÇTL ÇAK ANH 65 | | 60 | 550050034 | BORU UZT YLD ANH 34 | | 61 |
| 700050070 | ÇTL ÇAK ANH 70 | | 60 | 550050070 | BORU UZT YLD ANH 70 | | 61 |
| 700050075 | ÇTL ÇAK ANH 75 | | 60 | 550050075 | BORU UZT YLD ANH 75 | | 61 |
| 700050080 | ÇTL ÇAK ANH 80 | | 60 | 550050080 | BORU UZT YLD ANH 80 | | 61 |
| 700050085 | ÇTL ÇAK ANH 85 | | 60 | 550050085 | BORU UZT YLD ANH 85 | | 61 |
| 700050090 | ÇTL ÇAK ANH 90 | | 60 | 550050090 | BORU UZT YLD ANH 90 | | 61 |
| 700050095 | ÇTL ÇAK ANH 95 | | 60 | 550050095 | BORU UZT YLD ANH 95 | | 61 |
| 700050100 | ÇTL ÇAK ANH 100 | | 60 | 550050100 | BORU UZT YLD ANH 100 | | 61 |
| 700050105 | ÇTL ÇAK ANH 105 | | 60 | 551050001 | DNDR KOL BORU 22-30 | | 61 |
| 700050110 | ÇTL ÇAK ANH 110 | | 60 | 551050002 | DNDR KOL BORU 32-41 | | 61 |
| 700050115 | ÇTL ÇAK ANH 115 | | 60 | 551050003 | DNDR KOL BORU 46-55 | | 61 |
| 700050120 | ÇTL ÇAK ANH 120 | | 60 | 551050004 | DNDR KOL BORU 60-100 | | 61 |
| 700050125 | ÇTL ÇAK ANH 125 | | 60 | 600011006 | KURB ANH 6" | | 61 |
| 700050130 | ÇTL ÇAK ANH 130 | | 60 | 600011008 | KURB ANH 8" | | 61 |
| 700050135 | ÇTL ÇAK ANH 135 | | 60 | 600011010 | KURB ANH 10" | | 61 |
| 700050140 | ÇTL ÇAK ANH 140 | | 60 | 600011012 | KURB ANH 12" | | 61 |
| 700050145 | ÇTL ÇAK ANH 145 | | 60 | 600011015 | KURB ANH 15" | | 61 |
| 700050150 | ÇTL ÇAK ANH 150 | | 60 | 860052528 | KNC ANH 4GEN UÇ 25/28 | | 61 |
| 750050024 | YLD ÇAK ANH 24 | | 60 | 860053032 | KNC ANH 4GEN UÇ 30/32 | | 61 |
| 750050027 | YLD ÇAK ANH 27 | | 60 | 860053436 | KNC ANH 4GEN UÇ 34/36 | | 61 |
| 750050030 | YLD ÇAK ANH 30 | | 60 | 860054042 | KNC ANH 4GEN UÇ 40/42 | | 61 |
| 750050032 | YLD ÇAK ANH 32 | | 60 | 860054550 | KNC ANH 4GEN UÇ 45/50 | | 61 |
| 750050036 | YLD ÇAK ANH 36 | | 60 | 860055255 | KNC ANH 4GEN UÇ 52/55 | | 61 |
| 750050038 | YLD ÇAK ANH 38 | | 60 | 860055862 | KNC ANH 4GEN UÇ 58/62 | | 61 |
| 750050041 | YLD ÇAK ANH 41 | | 60 | 860056875 | KNC ANH 4GEN UÇ 68/75 | | 61 |
| 750050042 | YLD ÇAK ANH 42 | | 60 | 860058090 | KNC ANH 4GEN UÇ 80/90 | | 61 |
| 750050046 | YLD ÇAK ANH 46 | | 60 | 860059510 | KNC ANH 4GEN UÇ 95/100 | | 61 |
| 750050047 | YLD ÇAK ANH 47 | | 60 | 615010200 | AYR MNT ANH 200 | | 62 |
| 750050050 | YLD ÇAK ANH 50 | | 60 | 1107060004 | 1/4" 6KŞ LKM ANH 04 | | 69 |

| KOD | ÜRÜN | FİYAT | SAYFA | KOD | ÜRÜN | FİYAT | SAYFA |
|------------|-------------------------------|-------|-------|------------|--------------------------------------|-------|-------|
| 1107060045 | 1/4" 6KŞ LKM ANH 4,5 | | 69 | 1507064115 | 1/4" T KOL | | 71 |
| 1107060005 | 1/4" 6KŞ LKM ANH 05 | | 69 | 1507062140 | 1/4" CRC KOL 140 | | 72 |
| 1107060055 | 1/4" 6KŞ LKM ANH 5,5 | | 69 | 1507066140 | 1/4" MAND CRC KOL 140 | | 72 |
| 1107060006 | 1/4" 6KŞ LKM ANH 06 | | 69 | 1507062150 | 1/4" MFSL CRC KOL 72DİŞ 150 | | 72 |
| 1107060007 | 1/4" 6KŞ LKM ANH 07 | | 69 | 1507062110 | 1/4" CRC KOL 72DİŞ LKM&BITS TUTC 110 | | 72 |
| 1107060008 | 1/4" 6KŞ LKM ANH 08 | | 69 | 1507067115 | 1/4" MFSL T CRC KOL 72DİŞ 115 | | 72 |
| 1107060009 | 1/4" 6KŞ LKM ANH 09 | | 69 | 1507060004 | 1/4"FX3/8" M LKM ADP | | 73 |
| 1107060010 | 1/4" 6KŞ LKM ANH 10 | | 69 | 1507064080 | 1/4" DRN LKM TRNV ADP | | 73 |
| 1107060011 | 1/4" 6KŞ LKM ANH 11 | | 69 | 1107065010 | 1/4" BITS TUTC LKM MIKN | | 73 |
| 1107060012 | 1/4" 6KŞ LKM ANH 12 | | 69 | 1107060015 | 1/4" 6KŞ LKM ANH SET15 | | 73 |
| 1107060013 | 1/4" 6KŞ LKM ANH 13 | | 69 | 1110060006 | 3/8" 6KŞ LKM ANH 06 | | 74 |
| 1107064004 | 1/4" 6KŞ DRN LKM ANH 04 | | 69 | 1110060007 | 3/8" 6KŞ LKM ANH 07 | | 74 |
| 1107064005 | 1/4" 6KŞ DRN LKM ANH 05 | | 69 | 1110060008 | 3/8" 6KŞ LKM ANH 08 | | 74 |
| 1107064055 | 1/4" 6KŞ DRN LKM ANH 5,5 | | 69 | 1110060009 | 3/8" 6KŞ LKM ANH 09 | | 74 |
| 1107064006 | 1/4" 6KŞ DRN LKM ANH 06 | | 69 | 1110060010 | 3/8" 6KŞ LKM ANH 10 | | 74 |
| 1107064007 | 1/4" 6KŞ DRN LKM ANH 07 | | 69 | 1110060011 | 3/8" 6KŞ LKM ANH 11 | | 74 |
| 1107064008 | 1/4" 6KŞ DRN LKM ANH 08 | | 69 | 1110060012 | 3/8" 6KŞ LKM ANH 12 | | 74 |
| 1107064009 | 1/4" 6KŞ DRN LKM ANH 09 | | 69 | 1110060013 | 3/8" 6KŞ LKM ANH 13 | | 74 |
| 1107064010 | 1/4" 6KŞ DRN LKM ANH 10 | | 69 | 1110060014 | 3/8" 6KŞ LKM ANH 14 | | 74 |
| 1107064011 | 1/4" 6KŞ DRN LKM ANH 11 | | 69 | 1110060015 | 3/8" 6KŞ LKM ANH 15 | | 74 |
| 1107064012 | 1/4" 6KŞ DRN LKM ANH 12 | | 69 | 1110060016 | 3/8" 6KŞ LKM ANH 16 | | 74 |
| 1107064013 | 1/4" 6KŞ DRN LKM ANH 13 | | 69 | 1110060017 | 3/8" 6KŞ LKM ANH 17 | | 74 |
| 1107060014 | 1/4" 6KŞ DRN LKM ANH SET14 | | 69 | 1110060018 | 3/8" 6KŞ LKM ANH 18 | | 74 |
| 1107061125 | 1/4" ALLEN UÇ LKM ANH 2,5 | | 70 | 1110060019 | 3/8" 6KŞ LKM ANH 19 | | 74 |
| 1107061103 | 1/4" ALLEN UÇ LKM ANH 03 | | 70 | 1110060021 | 3/8" 6KŞ LKM ANH 21 | | 74 |
| 1107061104 | 1/4" ALLEN UÇ LKM ANH 04 | | 70 | 1110060022 | 3/8" 6KŞ LKM ANH 22 | | 74 |
| 1107061105 | 1/4" ALLEN UÇ LKM ANH 05 | | 70 | 1110060023 | 3/8" 6KŞ LKM ANH 23 | | 74 |
| 1107061106 | 1/4" ALLEN UÇ LKM ANH 06 | | 70 | 1110069208 | 3/8" BUJİ LKM LSTK 20,8 | | 74 |
| 1107061107 | 1/4" ALLEN UÇ LKM ANH 07 | | 70 | 1510060200 | 3/8" CRC KOL 200 | | 74 |
| 1107061108 | 1/4" ALLEN UÇ LKM ANH 08 | | 70 | 1510060075 | 3/8" ARA KOL 75 | | 74 |
| 1107061110 | 1/4" ALLEN UÇ LKM ANH 10 | | 70 | 1510060150 | 3/8" ARA KOL 150 | | 74 |
| 1107061208 | 1/4" TORX UÇ LKM ANH T8 | | 70 | 1510060056 | 3/8" MFSL 56,5 | | 74 |
| 1107061209 | 1/4" TORX UÇ LKM ANH T9 | | 70 | 1510061200 | 3/8" T KOL | | 75 |
| 1107061210 | 1/4" TORX UÇ LKM ANH T10 | | 70 | 1510060007 | 3/8"FX1/2M" LKM ADP | | 75 |
| 1107061215 | 1/4" TORX UÇ LKM ANH T15 | | 70 | 1110060019 | 3/8" 6KŞ LKM SET19 | | 75 |
| 1107061220 | 1/4" TORX UÇ LKM ANH T20 | | 70 | 1113006145 | 1/2" LKM ANH&SHP SET146 | | 76 |
| 1107061225 | 1/4" TORX UÇ LKM ANH T25 | | 70 | 1113061008 | 1/2" 6KŞ LKM ANH 08 | | 76 |
| 1107061227 | 1/4" TORX UÇ LKM ANH T27 | | 70 | 1113061009 | 1/2" 6KŞ LKM ANH 09 | | 76 |
| 1107061230 | 1/4" TORX UÇ LKM ANH T30 | | 70 | 1113061010 | 1/2" 6KŞ LKM ANH 10 | | 76 |
| 1107061240 | 1/4" TORX UÇ LKM ANH T40 | | 70 | 1113061011 | 1/2" 6KŞ LKM ANH 11 | | 76 |
| 1107061308 | 1/4" DLK TORX UÇ LKM ANH TR8 | | 70 | 1113061012 | 1/2" 6KŞ LKM ANH 12 | | 76 |
| 1107061309 | 1/4" DLK TORX UÇ LKM ANH TR9 | | 70 | 1113061013 | 1/2" 6KŞ LKM ANH 13 | | 76 |
| 1107061310 | 1/4" DLK TORX UÇ LKM ANH TR10 | | 70 | 1113061014 | 1/2" 6KŞ LKM ANH 14 | | 76 |
| 1107061315 | 1/4" DLK TORX UÇ LKM ANH TR15 | | 70 | 1113061015 | 1/2" 6KŞ LKM ANH 15 | | 76 |
| 1107061320 | 1/4" DLK TORX UÇ LKM ANH TR20 | | 70 | 1113061016 | 1/2" 6KŞ LKM ANH 16 | | 76 |
| 1107061325 | 1/4" DLK TORX UÇ LKM ANH TR25 | | 70 | 1113061017 | 1/2" 6KŞ LKM ANH 17 | | 76 |
| 1107061327 | 1/4" DLK TORX UÇ LKM ANH TR27 | | 70 | 1113061018 | 1/2" 6KŞ LKM ANH 18 | | 76 |
| 1107061330 | 1/4" DLK TORX UÇ LKM ANH TR30 | | 70 | 1113061019 | 1/2" 6KŞ LKM ANH 19 | | 76 |
| 1107061340 | 1/4" DLK TORX UÇ LKM ANH TR40 | | 70 | 1113061020 | 1/2" 6KŞ LKM ANH 20 | | 76 |
| 1107061403 | 1/4" DÜZ UÇ LKM ANH 03 | | 70 | 1113061021 | 1/2" 6KŞ LKM ANH 21 | | 76 |
| 1107061435 | 1/4" DÜZ UÇ LKM ANH 3,5 | | 70 | 1113061022 | 1/2" 6KŞ LKM ANH 22 | | 76 |
| 1107061404 | 1/4" DÜZ UÇ LKM ANH 04 | | 70 | 1113061023 | 1/2" 6KŞ LKM ANH 23 | | 76 |
| 1107061445 | 1/4" DÜZ UÇ LKM ANH 4,5 | | 70 | 1113061024 | 1/2" 6KŞ LKM ANH 24 | | 76 |
| 1107061455 | 1/4" DÜZ UÇ LKM ANH 5,5 | | 70 | 1113061025 | 1/2" 6KŞ LKM ANH 25 | | 76 |
| 1107061465 | 1/4" DÜZ UÇ LKM ANH 6,5 | | 70 | 1113061026 | 1/2" 6KŞ LKM ANH 26 | | 76 |
| 1107061407 | 1/4" DÜZ UÇ LKM ANH 07 | | 70 | 1113061027 | 1/2" 6KŞ LKM ANH 27 | | 76 |
| 1107061408 | 1/4" DÜZ UÇ LKM ANH 08 | | 70 | 1113061028 | 1/2" 6KŞ LKM ANH 28 | | 76 |
| 1107061410 | 1/4" DÜZ UÇ LKM ANH 10 | | 70 | 1113061029 | 1/2" 6KŞ LKM ANH 29 | | 76 |
| 1107061501 | 1/4" YLD UÇ LKM ANH PH1 | | 71 | 1113061030 | 1/2" 6KŞ LKM ANH 30 | | 76 |
| 1107061502 | 1/4" YLD UÇ LKM ANH PH2 | | 71 | 1113061032 | 1/2" 6KŞ LKM ANH 32 | | 76 |
| 1107061503 | 1/4" YLD UÇ LKM ANH PH3 | | 71 | 1114061010 | 1/2" 12KŞ LKM ANH 10 | | 77 |
| 1107061504 | 1/4" YLD UÇ LKM ANH PH4 | | 71 | 1114061011 | 1/2" 12KŞ LKM ANH 11 | | 77 |
| 1107001042 | 1/4" BITS UÇ LKM ANH SET42 | | 71 | 1114061012 | 1/2" 12KŞ LKM ANH 12 | | 77 |
| 1507060050 | 1/4" ARA KOL 50 | | 71 | 1114061013 | 1/2" 12KŞ LKM ANH 13 | | 77 |
| 1507060100 | 1/4" ARA KOL 100 | | 71 | 1114061014 | 1/2" 12KŞ LKM ANH 14 | | 77 |
| 1507063150 | 1/4" ARA KOL FLEX 150 | | 71 | 1114061015 | 1/2" 12KŞ LKM ANH 15 | | 77 |
| 1507060038 | 1/4" MFSL | | 71 | 1114061016 | 1/2" 12KŞ LKM ANH 16 | | 77 |

| KOD | ÜRÜN | FİYAT | SAYFA | KOD | ÜRÜN | FİYAT | SAYFA |
|------------|------------------------------|-------|-------|------------|-------------------------------------|-------|-------|
| 1114061017 | 1/2" 12KŞ LKM ANH 17 | | 77 | 1113001107 | 1/2" ALLEN UÇ LKM ANH TK7 | | 79 |
| 1114061018 | 1/2" 12KŞ LKM ANH 18 | | 77 | 1113061220 | 1/2" TORX UÇ LKM ANH T20 60 | | 79 |
| 1114061019 | 1/2" 12KŞ LKM ANH 19 | | 77 | 1113061225 | 1/2" TORX UÇ LKM ANH T25 60 | | 79 |
| 1114061020 | 1/2" 12KŞ LKM ANH 20 | | 77 | 1113061227 | 1/2" TORX UÇ LKM ANH T27 60 | | 79 |
| 1114061021 | 1/2" 12KŞ LKM ANH 21 | | 77 | 1113061230 | 1/2" TORX UÇ LKM ANH T30 60 | | 79 |
| 1114061022 | 1/2" 12KŞ LKM ANH 22 | | 77 | 1113061240 | 1/2" TORX UÇ LKM ANH T40 60 | | 79 |
| 1114061023 | 1/2" 12KŞ LKM ANH 23 | | 77 | 1113061245 | 1/2" TORX UÇ LKM ANH T45 60 | | 79 |
| 1114061024 | 1/2" 12KŞ LKM ANH 24 | | 77 | 1113061250 | 1/2" TORX UÇ LKM ANH T50 60 | | 79 |
| 1114061026 | 1/2" 12KŞ LKM ANH 26 | | 77 | 1113061255 | 1/2" TORX UÇ LKM ANH T55 60 | | 79 |
| 1114061027 | 1/2" 12KŞ LKM ANH 27 | | 77 | 1113061260 | 1/2" TORX UÇ LKM ANH T60 60 | | 79 |
| 1114061028 | 1/2" 12KŞ LKM ANH 28 | | 77 | 1113064220 | 1/2" TORX UÇ LKM ANH T20 100 | | 79 |
| 1114061030 | 1/2" 12KŞ LKM ANH 30 | | 77 | 1113064225 | 1/2" TORX UÇ LKM ANH T25 100 | | 79 |
| 1114061032 | 1/2" 12KŞ LKM ANH 32 | | 77 | 1113064227 | 1/2" TORX UÇ LKM ANH T27 100 | | 79 |
| 1413061008 | 1/2" 12KŞ LKM ANH 5/16 SAE | | 77 | 1113064230 | 1/2" TORX UÇ LKM ANH T30 100 | | 79 |
| 1413061095 | 1/2" 12KŞ LKM ANH 3/8 SAE | | 77 | 1113064240 | 1/2" TORX UÇ LKM ANH T40 100 | | 79 |
| 1413061010 | 1/2" 12KŞ LKM ANH 7/16 SAE | | 77 | 1113064245 | 1/2" TORX UÇ LKM ANH T45 100 | | 79 |
| 1413061011 | 1/2" 12KŞ LKM ANH 15/32 SAE | | 77 | 1113064250 | 1/2" TORX UÇ LKM ANH T50 100 | | 79 |
| 1413061012 | 1/2" 12KŞ LKM ANH 1/2 SAE | | 77 | 1113064255 | 1/2" TORX UÇ LKM ANH T55 100 | | 79 |
| 1413061013 | 1/2" 12KŞ LKM ANH 9/16 SAE | | 77 | 1113064260 | 1/2" TORX UÇ LKM ANH T60 100 | | 79 |
| 1413061014 | 1/2" 12KŞ LKM ANH 19/32 SAE | | 77 | 1113066009 | 1/2" TORX UÇ LKM ANH TK9 | | 79 |
| 1413061015 | 1/2" 12KŞ LKM ANH 5/8 SAE | | 77 | 1113066017 | 1/2" ALLEN UÇ&TORX UÇ LKM ANH SET17 | | 80 |
| 1413061016 | 1/2" 12KŞ LKM ANH 11/16 SAE | | 77 | 1114064005 | 1/2" 12KŞ LKM BİTS XZN M5 60 | | 80 |
| 1413061017 | 1/2" 12KŞ LKM ANH 3/4 SAE | | 77 | 1114064006 | 1/2" 12KŞ LKM BİTS XZN M6 60 | | 80 |
| 1413061020 | 1/2" 12KŞ LKM ANH 25/32 SAE | | 77 | 1114064008 | 1/2" 12KŞ LKM BİTS XZN M8 60 | | 80 |
| 1413061021 | 1/2" 12KŞ LKM ANH 13/16 SAE | | 77 | 1114064010 | 1/2" 12KŞ LKM BİTS XZN M10 60 | | 80 |
| 1413061022 | 1/2" 12KŞ LKM ANH 7/8 SAE | | 77 | 1114064012 | 1/2" 12KŞ LKM BİTS XZN M12 60 | | 80 |
| 1413061024 | 1/2" 12KŞ LKM ANH 15/16 SAE | | 77 | 1114064106 | 1/2" 12KŞ LKM BİTS XZN M6 80 | | 80 |
| 1413061025 | 1/2" 12KŞ LKM ANH 1 SAE | | 77 | 1114064108 | 1/2" 12KŞ LKM BİTS XZN M8 80 | | 80 |
| 1413061027 | 1/2" 12KŞ LKM ANH 1-1/16 SAE | | 77 | 1114064110 | 1/2" 12KŞ LKM BİTS XZN M10 80 | | 80 |
| 1413061029 | 1/2" 12KŞ LKM ANH 1-1/8 SAE | | 77 | 1114064112 | 1/2" 12KŞ LKM BİTS XZN M12 80 | | 80 |
| 1413061030 | 1/2" 12KŞ LKM ANH 1-3/16 SAE | | 77 | 1114064114 | 1/2" 12KŞ LKM BİTS XZN M14 80 | | 80 |
| 1413061032 | 1/2" 12KŞ LKM ANH 1-1/4 SAE | | 77 | 1114064208 | 1/2" 12KŞ LKM BİTS XZN M8 140 | | 80 |
| 1113069160 | 1/2" BUJİ LKM LSTK 16 | | 77 | 1114064210 | 1/2" 12KŞ LKM BİTS XZN M10 140 | | 80 |
| 1113069208 | 1/2" BUJİ LKM LSTK 20,8 | | 77 | 1114064212 | 1/2" 12KŞ LKM BİTS XZN M12 140 | | 80 |
| 1108060010 | 1/2" 6KŞ DRN LKM ANH 10 | | 78 | 1114064214 | 1/2" 12KŞ LKM BİTS XZN M14 140 | | 80 |
| 1108060011 | 1/2" 6KŞ DRN LKM ANH 11 | | 78 | 1114064216 | 1/2" 12KŞ LKM BİTS XZN M16 140 | | 80 |
| 1108060012 | 1/2" 6KŞ DRN LKM ANH 12 | | 78 | 1114065004 | 1/2" LKM BİTS UÇ RİBE M4 | | 80 |
| 1108060013 | 1/2" 6KŞ DRN LKM ANH 13 | | 78 | 1114065005 | 1/2" LKM BİTS UÇ RİBE M5 | | 80 |
| 1108060014 | 1/2" 6KŞ DRN LKM ANH 14 | | 78 | 1114065006 | 1/2" LKM BİTS UÇ RİBE M6 | | 80 |
| 1108060015 | 1/2" 6KŞ DRN LKM ANH 15 | | 78 | 1114065007 | 1/2" LKM BİTS UÇ RİBE M7 | | 80 |
| 1108060016 | 1/2" 6KŞ DRN LKM ANH 16 | | 78 | 1114065008 | 1/2" LKM BİTS UÇ RİBE M8 | | 80 |
| 1108060017 | 1/2" 6KŞ DRN LKM ANH 17 | | 78 | 1114065009 | 1/2" LKM BİTS UÇ RİBE M9 | | 80 |
| 1108060018 | 1/2" 6KŞ DRN LKM ANH 18 | | 78 | 1114065010 | 1/2" LKM BİTS UÇ RİBE M10 | | 80 |
| 1108060019 | 1/2" 6KŞ DRN LKM ANH 19 | | 78 | 1114065011 | 1/2" LKM BİTS UÇ RİBE M10,5 | | 80 |
| 1108060010 | 1/2" 6KŞ DRN LKM TK10 | | 78 | 1114065012 | 1/2" LKM BİTS UÇ RİBE M12 | | 80 |
| 1113060210 | 1/2" TORX LKM ANH E10 | | 78 | 1114065013 | 1/2" LKM BİTS UÇ RİBE M13 | | 80 |
| 1113060212 | 1/2" TORX LKM ANH E12 | | 78 | 1114065014 | 1/2" LKM BİTS UÇ RİBE M14 | | 80 |
| 1113060214 | 1/2" TORX LKM ANH E14 | | 78 | 1114065016 | 1/2" LKM BİTS UÇ RİBE M16 | | 80 |
| 1113060216 | 1/2" TORX LKM ANH E16 | | 78 | 1513060032 | 1/2" CRC KOL 32DİŞ 250 | | 81 |
| 1113060218 | 1/2" TORX LKM ANH E18 | | 78 | 1513064075 | 1/2" ARA KOL 75 | | 81 |
| 1113060220 | 1/2" TORX LKM ANH E20 | | 78 | 1513064125 | 1/2" ARA KOL 125 | | 81 |
| 1113060007 | 1/2" TORX LKM ANH SET7 | | 78 | 1513064250 | 1/2" ARA KOL 250 | | 81 |
| 1113061105 | 1/2" ALLEN UÇ LKM ANH 05 60 | | 79 | 1513065250 | 1/2" T KOL LKM ADP | | 81 |
| 1113061106 | 1/2" ALLEN UÇ LKM ANH 06 60 | | 79 | 1513062250 | 1/2" T KOL 250 | | 81 |
| 1113061107 | 1/2" ALLEN UÇ LKM ANH 07 60 | | 79 | 1513064070 | 1/2" MFSL 70 | | 81 |
| 1113061108 | 1/2" ALLEN UÇ LKM ANH 08 60 | | 79 | 1513060002 | 1/2"FX3/8" M LKM ADP | | 81 |
| 1113061110 | 1/2" ALLEN UÇ LKM ANH 10 60 | | 79 | 1513060003 | 1/2"FX3/4" M LKM ADP | | 81 |
| 1113061112 | 1/2" ALLEN UÇ LKM ANH 12 60 | | 79 | 1113065010 | 1/2" BİTS TUTC LKM | | 81 |
| 1113061114 | 1/2" ALLEN UÇ LKM ANH 14 60 | | 79 | 1113001038 | 1/4"&1/2" 6KŞ LKM ANH SET35 | | 82 |
| 1113064105 | 1/2" ALLEN UÇ LKM ANH 05 100 | | 79 | 1113002017 | 1/2" 6KŞ LKM ANH SET17 | | 83 |
| 1113064106 | 1/2" ALLEN UÇ LKM ANH 06 100 | | 79 | 1114006024 | 1/2" 12KŞ LKM ANH SET24 | | 83 |
| 1113064107 | 1/2" ALLEN UÇ LKM ANH 07 100 | | 79 | 1113002024 | 1/2" 6KŞ LKM ANH SET24 | | 83 |
| 1113064108 | 1/2" ALLEN UÇ LKM ANH 08 100 | | 79 | 1413006024 | 1/2" 12KŞ LKM ANH SET24 SAE | | 83 |
| 1113064110 | 1/2" ALLEN UÇ LKM ANH 10 100 | | 79 | 1119061022 | 3/4" 6KŞ LKM ANH 22 | | 85 |
| 1113064112 | 1/2" ALLEN UÇ LKM ANH 12 100 | | 79 | 1119061024 | 3/4" 6KŞ LKM ANH 24 | | 85 |
| 1113064114 | 1/2" ALLEN UÇ LKM ANH 14 100 | | 79 | 1119061027 | 3/4" 6KŞ LKM ANH 27 | | 85 |
| 1113064117 | 1/2" ALLEN UÇ LKM ANH 17 100 | | 79 | 1119061030 | 3/4" 6KŞ LKM ANH 30 | | 85 |

| KOD | ÜRÜN | FİYAT | SAYFA | KOD | ÜRÜN | FİYAT | SAYFA |
|------------|-------------------------------|-------|-------|------------|-----------------------------|-------|-------|
| 1119061032 | 3/4" 6KŞ LKM ANH 32 | | 85 | 1108067011 | 1/2" 6KŞ HVL DRN LKM ANH 11 | | 88 |
| 1119061034 | 3/4" 6KŞ LKM ANH 34 | | 85 | 1108067012 | 1/2" 6KŞ HVL DRN LKM ANH 12 | | 88 |
| 1119061036 | 3/4" 6KŞ LKM ANH 36 | | 85 | 1108067013 | 1/2" 6KŞ HVL DRN LKM ANH 13 | | 88 |
| 1119061038 | 3/4" 6KŞ LKM ANH 38 | | 85 | 1108067014 | 1/2" 6KŞ HVL DRN LKM ANH 14 | | 88 |
| 1119061041 | 3/4" 6KŞ LKM ANH 41 | | 85 | 1108067015 | 1/2" 6KŞ HVL DRN LKM ANH 15 | | 88 |
| 1119061046 | 3/4" 6KŞ LKM ANH 46 | | 85 | 1108067016 | 1/2" 6KŞ HVL DRN LKM ANH 16 | | 88 |
| 1119061050 | 3/4" 6KŞ LKM ANH 50 | | 85 | 1108067017 | 1/2" 6KŞ HVL DRN LKM ANH 17 | | 88 |
| 1119061055 | 3/4" 6KŞ LKM ANH 55 | | 85 | 1108067018 | 1/2" 6KŞ HVL DRN LKM ANH 18 | | 88 |
| 1119061060 | 3/4" 6KŞ LKM ANH 60 | | 85 | 1108067019 | 1/2" 6KŞ HVL DRN LKM ANH 19 | | 88 |
| 1120061022 | 3/4" 12KŞ LKM ANH 22 | | 85 | 1108067021 | 1/2" 6KŞ HVL DRN LKM ANH 21 | | 88 |
| 1120061024 | 3/4" 12KŞ LKM ANH 24 | | 85 | 1108067022 | 1/2" 6KŞ HVL DRN LKM ANH 22 | | 88 |
| 1120061027 | 3/4" 12KŞ LKM ANH 27 | | 85 | 1108067024 | 1/2" 6KŞ HVL DRN LKM ANH 24 | | 88 |
| 1120061030 | 3/4" 12KŞ LKM ANH 30 | | 85 | 1108067027 | 1/2" 6KŞ HVL DRN LKM ANH 27 | | 88 |
| 1120061032 | 3/4" 12KŞ LKM ANH 32 | | 85 | 1108067030 | 1/2" 6KŞ HVL DRN LKM ANH 30 | | 88 |
| 1120061034 | 3/4" 12KŞ LKM ANH 34 | | 85 | 1108067032 | 1/2" 6KŞ HVL DRN LKM ANH 32 | | 88 |
| 1120061036 | 3/4" 12KŞ LKM ANH 36 | | 85 | 1513067002 | 1/2"FX3/8" M HVL LKM ADP | | 88 |
| 1120061041 | 3/4" 12KŞ LKM ANH 41 | | 85 | 1513067003 | 1/2"FX3/4" M HVL LKM ADP | | 88 |
| 1120061046 | 3/4" 12KŞ LKM ANH 46 | | 85 | 1513067075 | 1/2" HVL LKM MFSL 75 | | 88 |
| 1120061050 | 3/4" 12KŞ LKM ANH 50 | | 85 | 1119067019 | 3/4" 6KŞ HVL LKM ANH 19 | | 89 |
| 1419061022 | 3/4" 12KŞ LKM ANH 7/8 SAE | | 85 | 1119067021 | 3/4" 6KŞ HVL LKM ANH 21 | | 89 |
| 1419061024 | 3/4" 12KŞ LKM ANH 15/16 SAE | | 85 | 1119067022 | 3/4" 6KŞ HVL LKM ANH 22 | | 89 |
| 1419061025 | 3/4" 12KŞ LKM ANH 1 SAE | | 85 | 1119067024 | 3/4" 6KŞ HVL LKM ANH 24 | | 89 |
| 1419061027 | 3/4" 12KŞ LKM ANH 1-1/16 SAE | | 85 | 1119067027 | 3/4" 6KŞ HVL LKM ANH 27 | | 89 |
| 1419061028 | 3/4" 12KŞ LKM ANH 1-1/8 SAE | | 85 | 1119067030 | 3/4" 6KŞ HVL LKM ANH 30 | | 89 |
| 1419061032 | 3/4" 12KŞ LKM ANH 1-1/4 SAE | | 85 | 1119067032 | 3/4" 6KŞ HVL LKM ANH 32 | | 89 |
| 1419061033 | 3/4" 12KŞ LKM ANH 1-5/16 SAE | | 85 | 1119067034 | 3/4" 6KŞ HVL LKM ANH 34 | | 89 |
| 1419061035 | 3/4" 12KŞ LKM ANH 1-3/8 SAE | | 85 | 1119067036 | 3/4" 6KŞ HVL LKM ANH 36 | | 89 |
| 1419061036 | 3/4" 12KŞ LKM ANH 1-7/16 SAE | | 85 | 1119067041 | 3/4" 6KŞ HVL LKM ANH 41 | | 89 |
| 1419061038 | 3/4" 12KŞ LKM ANH 1-1/2 SAE | | 85 | 1119067046 | 3/4" 6KŞ HVL LKM ANH 46 | | 89 |
| 1419061041 | 3/4" 12KŞ LKM ANH 1-5/8 SAE | | 85 | 1519067175 | 3/4" HVL LKM ARA KOL 175 | | 89 |
| 1419061044 | 3/4" 12KŞ LKM ANH 1-3/4 SAE | | 85 | 1519067250 | 3/4" HVL LKM ARA KOL 250 | | 89 |
| 1419061046 | 3/4" 12KŞ LKM ANH 1-13/16 SAE | | 85 | 1519067330 | 3/4" HVL LKM ARA KOL 330 | | 89 |
| 1419061047 | 3/4" 12KŞ LKM ANH 1-7/8 SAE | | 85 | 1519067108 | 3/4" HVL LKM MFSL 108 | | 89 |
| 1419061050 | 3/4" 12KŞ LKM ANH 2 SAE | | 85 | 1519067011 | 3/4"FX1/2" M HVL LKM ADP | | 89 |
| 1519064510 | 3/4" CRC KOL 510 | | 85 | 1125067024 | 1" 6KŞ HVL LKM ANH 24 | | 90 |
| 1519064200 | 3/4" ARA KOL 200 | | 85 | 1125067027 | 1" 6KŞ HVL LKM ANH 27 | | 90 |
| 1519064400 | 3/4" ARA KOL 400 | | 85 | 1125067030 | 1" 6KŞ HVL LKM ANH 30 | | 90 |
| 1519064500 | 3/4" T KOL 500 | | 86 | 1125067032 | 1" 6KŞ HVL LKM ANH 32 | | 90 |
| 1519060008 | 3/4"FX1/2" M LKM ADP | | 86 | 1125067033 | 1" 6KŞ HVL LKM ANH 33 | | 90 |
| 1519060001 | 3/4"FX1" M LKM ADP | | 86 | 1125067034 | 1" 6KŞ HVL LKM ANH 34 | | 90 |
| 111906114 | 3/4" 6KŞ LKM ANH SET14 | | 86 | 1125067036 | 1" 6KŞ HVL LKM ANH 36 | | 90 |
| 112006014 | 3/4" 12KŞ LKM ANH SET14 | | 86 | 1125067038 | 1" 6KŞ HVL LKM ANH 38 | | 90 |
| 141906114 | 3/4" 12KŞ LKM ANH SET14 SAE | | 86 | 1125067041 | 1" 6KŞ HVL LKM ANH 41 | | 90 |
| 1225060036 | 1" 12KŞ LKM ANH 36 | | 87 | 1125067046 | 1" 6KŞ HVL LKM ANH 46 | | 90 |
| 1225060041 | 1" 12KŞ LKM ANH 41 | | 87 | 1125067050 | 1" 6KŞ HVL LKM ANH 50 | | 90 |
| 1225060046 | 1" 12KŞ LKM ANH 46 | | 87 | 1125067055 | 1" 6KŞ HVL LKM ANH 55 | | 90 |
| 1225060050 | 1" 12KŞ LKM ANH 50 | | 87 | 1125067060 | 1" 6KŞ HVL LKM ANH 60 | | 90 |
| 1225060055 | 1" 12KŞ LKM ANH 55 | | 87 | 1525067175 | 1" HVL LKM ARA KOL 175 | | 90 |
| 1225060060 | 1" 12KŞ LKM ANH 60 | | 87 | 1525067250 | 1" HVL LKM ARA KOL 250 | | 90 |
| 1525060005 | 1"FX3/4" M LKM ADP | | 87 | 1525067330 | 1" HVL LKM ARA KOL 330 | | 90 |
| 1113009003 | 1/2" 6KŞ JNT LKM ANH TK3 | | 87 | 1525067128 | 1" HVL LKM MFSL 128 | | 90 |
| 1113067010 | 1/2" 6KŞ HVL LKM ANH 10 | | 88 | 1525067015 | 1"FX3/4" M HVL LKM ADP | | 90 |
| 1113067011 | 1/2" 6KŞ HVL LKM ANH 11 | | 88 | 1800070607 | 2A KVN ANH 0607 | | 91 |
| 1113067012 | 1/2" 6KŞ HVL LKM ANH 12 | | 88 | 1800070809 | 2A KVN ANH 0809 | | 91 |
| 1113067013 | 1/2" 6KŞ HVL LKM ANH 13 | | 88 | 1800071011 | 2A KVN ANH 1011 | | 91 |
| 1113067014 | 1/2" 6KŞ HVL LKM ANH 14 | | 88 | 1800071213 | 2A KVN ANH 1213 | | 91 |
| 1113067015 | 1/2" 6KŞ HVL LKM ANH 15 | | 88 | 1800071415 | 2A KVN ANH 1415 | | 91 |
| 1113067016 | 1/2" 6KŞ HVL LKM ANH 16 | | 88 | 1800071617 | 2A KVN ANH 1617 | | 91 |
| 1113067017 | 1/2" 6KŞ HVL LKM ANH 17 | | 88 | 1800071819 | 2A KVN ANH 1819 | | 91 |
| 1113067018 | 1/2" 6KŞ HVL LKM ANH 18 | | 88 | 1800072022 | 2A KVN ANH 2022 | | 91 |
| 1113067019 | 1/2" 6KŞ HVL LKM ANH 19 | | 88 | 1800072224 | 2A KVN ANH 2224 | | 91 |
| 1113067021 | 1/2" 6KŞ HVL LKM ANH 21 | | 88 | 1800072427 | 2A KVN ANH 2427 | | 91 |
| 1113067022 | 1/2" 6KŞ HVL LKM ANH 22 | | 88 | 1800002108 | 2A KVN ANH SET10 | | 91 |
| 1113067024 | 1/2" 6KŞ HVL LKM ANH 24 | | 88 | 1841070021 | 1A KVN ANH&MİL 21 SET2 | | 91 |
| 1113067027 | 1/2" 6KŞ HVL LKM ANH 27 | | 88 | 1850075125 | KVN ANH MİL 5X125 | | 91 |
| 1513067125 | 1/2" HVL LKM ARA KOL 125 | | 88 | 1850078180 | KVN ANH MİL 8X180 | | 91 |
| 1108067010 | 1/2" 6KŞ HVL DRN LKM ANH 10 | | 88 | | | | |

| KOD | ÜRÜN | FİYAT | SAYFA | KOD | ÜRÜN | FİYAT | SAYFA |
|------------|-----------------------------|-------|-------|------------|-----------------------------|-------|-------|
| 1850071120 | KVN ANH MİL 10X120 | | 91 | 3020123160 | KRAFT KMB PNS 160 | | 101 |
| 1850071200 | KVN ANH MİL 10X200 | | 91 | 3020123180 | KRAFT KMB PNS 180 | | 101 |
| 1870092427 | AGR 2A BJN ANH UB 2427 | | 91 | 3020123200 | KRAFT KMB PNS 200 | | 101 |
| 1870092730 | AGR 2A BJN ANH UB 2730 | | 91 | 3020125160 | ERGO KMB PNS 160 | | 101 |
| 1870092732 | AGR 2A BJN ANH UB 2732 | | 91 | 3020125180 | ERGO KMB PNS 180 | | 101 |
| 1870093032 | AGR 2A BJN ANH UB 3032 | | 91 | 3020125200 | ERGO KMB PNS 200 | | 101 |
| 1870093233 | AGR 2A BJN ANH UB 3233 | | 91 | 3020126160 | 1000V KMB PNS 160 | | 101 |
| 1874092224 | AGR 2A BJN ANH KB 2224 | | 91 | 3020126180 | 1000V KMB PNS 180 | | 101 |
| 1874092427 | AGR 2A BJN ANH KB 2427 | | 91 | 3020126200 | 1000V KMB PNS 200 | | 101 |
| 1850091630 | BJN ANH MİL 18X630 | | 91 | 3030122180 | AGR KMB PNS 180 | | 101 |
| 1975091719 | BJN ANH İSTV | | 92 | 3030122200 | AGR KMB PNS 200 | | 101 |
| 1975091322 | 1/2" ADP BJN ANH İSTV | | 92 | 3220132140 | OPAK DÜZ UÇ KRGB 140 | | 102 |
| 1940090017 | BJN ANH PİPO TRNV UÇ 17 | | 92 | 3220132160 | OPAK DÜZ UÇ KRGB 160 | | 102 |
| 1940090019 | BJN ANH PİPO TRNV UÇ 19 | | 92 | 3220132180 | OPAK DÜZ UÇ KRGB 180 | | 102 |
| 1940090021 | BJN ANH PİPO TRNV UÇ 21 | | 92 | 3220132200 | OPAK DÜZ UÇ KRGB 200 | | 102 |
| 1840080500 | 1/2" MFSL T KOL 500 | | 92 | 3220133140 | KRAFT DÜZ UÇ KRGB 140 | | 102 |
| 1855080008 | MFSL T KOL LKM 08 | | 92 | 3220133160 | KRAFT DÜZ UÇ KRGB 160 | | 102 |
| 1855080010 | MFSL T KOL LKM 10 | | 92 | 3220133180 | KRAFT DÜZ UÇ KRGB 180 | | 102 |
| 1855080012 | MFSL T KOL LKM 12 | | 92 | 3220133200 | KRAFT DÜZ UÇ KRGB 200 | | 102 |
| 1855080013 | MFSL T KOL LKM 13 | | 92 | 3220135140 | ERGO DÜZ UÇ KRGB 140 | | 102 |
| 1855080017 | MFSL T KOL LKM 17 | | 92 | 3220135160 | ERGO DÜZ UÇ KRGB 160 | | 102 |
| 1855080019 | MFSL T KOL LKM 19 | | 92 | 3220135180 | ERGO DÜZ UÇ KRGB 180 | | 102 |
| 1610060100 | 3/8" TORK ANH 2,5-11NM | | 93 | 3220135200 | ERGO DÜZ UÇ KRGB 200 | | 102 |
| 1610060300 | 3/8" TORK ANH 7-33NM | | 93 | 3220136140 | 1000V DÜZ UÇ KRGB 140 | | 102 |
| 1613061200 | 1/2" TORK ANH 25-135NM | | 93 | 3220136160 | 1000V DÜZ UÇ KRGB 160 | | 102 |
| 1613062000 | 1/2" TORK ANH 50-225NM | | 93 | 3220136180 | 1000V DÜZ UÇ KRGB 180 | | 102 |
| 1613063000 | 1/2" TORK ANH 70-330NM | | 93 | 3220136200 | 1000V DÜZ UÇ KRGB 200 | | 102 |
| 1619062080 | 3/4" TORK ANH 200-800NM | | 93 | 3225132160 | OPAK EĞRİ UÇ KRGB 160 | | 103 |
| 1607060420 | 1/4" CRC TORK ANH 4-20NM | | 93 | 3225132180 | OPAK EĞRİ UÇ KRGB 180 | | 103 |
| 1610062010 | 3/8" CRC TORK ANH 20-100NM | | 93 | 3225132200 | OPAK EĞRİ UÇ KRGB 200 | | 103 |
| 1613064020 | 1/2" CRC TORK ANH 40-200NM | | 93 | 302002003 | OPAK PNS 160 SET3 | | 103 |
| 1613066034 | 1/2" CRC TORK ANH 60-340NM | | 93 | 3225133160 | KRAFT EĞRİ UÇ KRGB 160 | | 103 |
| 1619061060 | 3/4" CRC TORK ANH 100-600NM | | 93 | 3225133180 | KRAFT EĞRİ UÇ KRGB 180 | | 103 |
| 2100100008 | STILSON BORU ANH 8" | | 97 | 3225133200 | KRAFT EĞRİ UÇ KRGB 200 | | 103 |
| 2100100010 | STILSON BORU ANH 10" | | 97 | 3020001002 | PNS&KNT KLM SET2 | | 103 |
| 2100100012 | STILSON BORU ANH 12" | | 97 | 3700162140 | OPAK YNKS 140 | | 104 |
| 2100100014 | STILSON BORU ANH 14" | | 97 | 3700162160 | OPAK YNKS 160 | | 104 |
| 2100100018 | STILSON BORU ANH 18" | | 97 | 3700162180 | OPAK YNKS 180 | | 104 |
| 2100100024 | STILSON BORU ANH 24" | | 97 | 3700163140 | KRAFT YNKS 140 | | 104 |
| 2110100008 | AGR BORU ANH 8" | | 97 | 3700163160 | KRAFT YNKS 160 | | 104 |
| 2110100010 | AGR BORU ANH 10" | | 97 | 3700163180 | KRAFT YNKS 180 | | 104 |
| 2110100012 | AGR BORU ANH 12" | | 97 | 3700165140 | ERGO YNKS 140 | | 104 |
| 2110100014 | AGR BORU ANH 14" | | 97 | 3700165160 | ERGO YNKS 160 | | 104 |
| 2110100018 | AGR BORU ANH 18" | | 97 | 3700165180 | ERGO YNKS 180 | | 104 |
| 2110100024 | AGR BORU ANH 24" | | 97 | 3700166140 | 1000V YNKS 140 | | 104 |
| 2110100036 | AGR BORU ANH 36" | | 97 | 3700166160 | 1000V YNKS 160 | | 104 |
| 2110100048 | AGR BORU ANH 48" | | 97 | 3700166180 | 1000V YNKS 180 | | 104 |
| 2201100010 | 1" MŞL BORU ANH 85 | | 97 | 3705165160 | YNKS İNCE UÇ 160 | | 106 |
| 2201100015 | 1-1/2" MŞL BORU ANH 85 | | 97 | 3730162160 | AGR YNKS 160 | | 106 |
| 2201100020 | 2" MŞL BORU ANH 85 | | 97 | 3730162200 | AGR YNKS 200 | | 106 |
| 2201100030 | 3" MŞL BORU ANH 85 | | 97 | 3335001004 | SGM PNS SET4 | | 106 |
| 2201100040 | 4" MŞL BORU ANH 85 | | 97 | 3301120140 | DÜZ UÇ DIŞ SGM PNS YAY 140 | | 107 |
| 2400110160 | ÜNV FORT PNS 160 | | 98 | 3301120180 | DÜZ UÇ DIŞ SGM PNS YAY 180 | | 107 |
| 2400110240 | ÜNV FORT PNS 240 | | 98 | 3301120225 | DÜZ UÇ DIŞ SGM PNS YAY 225 | | 107 |
| 2400110315 | ÜNV FORT PNS 315 | | 98 | 3301120295 | DÜZ UÇ DIŞ SGM PNS YAY 295 | | 107 |
| 2400116240 | 1000V ÜNV FORT PNS 240 | | 99 | 3311120125 | EĞRİ UÇ DIŞ SGM PNS YAY 125 | | 107 |
| 2415110240 | FORT PNS YAY 240 | | 99 | 3311120170 | EĞRİ UÇ DIŞ SGM PNS YAY 170 | | 107 |
| 2500110250 | ÜNV AYR PNS 250 | | 99 | 3311120210 | EĞRİ UÇ DIŞ SGM PNS YAY 210 | | 107 |
| 2505110250 | STD AYR PNS 250 | | 99 | 3311120275 | EĞRİ UÇ DIŞ SGM PNS YAY 275 | | 107 |
| 2510110250 | SPCL AYR PNS 250 | | 99 | 3321120140 | DÜZ UÇ İÇ SGM PNS YAYZ 140 | | 107 |
| 2511110280 | CTIP AYR PNS 280 | | 99 | 3321120180 | DÜZ UÇ İÇ SGM PNS YAYZ 180 | | 107 |
| 2512110200 | KYNK AYR PNS DÜZ AĞZ 200 | | 100 | 3321120225 | DÜZ UÇ İÇ SGM PNS YAYZ 225 | | 107 |
| 2513110280 | KYNK AYR PNS BORU AĞZ 280 | | 100 | 3321120310 | DÜZ UÇ İÇ SGM PNS YAYZ 310 | | 107 |
| 2515110270 | KPRT AYR PNS 270 | | 100 | 3331120130 | EĞRİ UÇ İÇ SGM PNS YAYZ 130 | | 107 |
| 3020122160 | OPAK KMB PNS 160 | | 101 | 3331120170 | EĞRİ UÇ İÇ SGM PNS YAYZ 170 | | 107 |
| 3020122180 | OPAK KMB PNS 180 | | 101 | 3331120210 | EĞRİ UÇ İÇ SGM PNS YAYZ 210 | | 107 |
| 3020122200 | OPAK KMB PNS 200 | | 101 | 3331120290 | EĞRİ UÇ İÇ SGM PNS YAYZ 290 | | 107 |

| KOD | ÜRÜN | FİYAT | SAYFA | KOD | ÜRÜN | FİYAT | SAYFA |
|------------|-----------------------------|-------|-------|------------|------------------------------|-------|-------|
| 3420120220 | HRTM KLPÇ PNS 220 | | 108 | 4120186200 | KRAFT YLD UÇ TRNV 6X200 | | 129 |
| 3425120220 | SKŞTİP HRTM KLPÇ PNS 235 | | 108 | 4120188150 | KRAFT YLD UÇ TRNV 8X150 | | 129 |
| 3852240225 | DLK ZMB 225 | | 108 | 4120181200 | KRAFT YLD UÇ TRNV 10X200 | | 129 |
| 3715160165 | 1A KBLO KSC | | 109 | 4120185300 | KRAFT YLD UÇ TRNV 4,5X300 | | 129 |
| 3715166165 | 1000V 1A KBLO KSC | | 109 | 4120186300 | KRAFT YLD UÇ TRNV 6X300 | | 129 |
| 3720160220 | 2A KBLO KSC | | 110 | 4120008106 | KRAFT YLD UÇ TRNV TK6 | | 129 |
| 3860260180 | TSTR ÇPRZ | | 110 | 4100008107 | KRAFT DÜZ&YLD UÇ TRNV SET7 | | 129 |
| 3550140125 | ELKTRO YNYSK 125 | | 111 | 4110175525 | KRAFT TPÇ DÜZ UÇ TRNV 5,5X25 | | 130 |
| 3551140125 | ELKTRO TPYSK 125 | | 111 | 4110175540 | KRAFT TPÇ DÜZ UÇ TRNV 5,5X40 | | 130 |
| 3552140125 | ELKTRO YVRL UÇ KRGB 125 | | 111 | 4110176525 | KRAFT TPÇ DÜZ UÇ TRNV 6,5X25 | | 130 |
| 3553140150 | ELKTRO DÜZ UÇ KRGB 150 | | 111 | 4110176540 | KRAFT TPÇ DÜZ UÇ TRNV 6,5X40 | | 130 |
| 3554140150 | ELKTRO KRGB UB 150 | | 111 | 4130184525 | KRAFT TPÇ YLD UÇ TRNV 4,5X25 | | 130 |
| 3555140150 | ELKTRO SVR UÇ DÜZ KRGB 150 | | 111 | 4130184540 | KRAFT TPÇ YLD UÇ TRNV 4,5X40 | | 130 |
| 3556140150 | ELKTRO SVR UÇ EĞRİ KRGB 150 | | 112 | 4130180625 | KRAFT TPÇ YLD UÇ TRNV 6X25 | | 130 |
| 3557140125 | ELKTRO PNS 125 | | 112 | 4130180640 | KRAFT TPÇ YLD UÇ TRNV 6X40 | | 130 |
| 3560002104 | ELKTRO KSK&PNS SET4 | | 112 | 4140172575 | 1000V DÜZ UÇ TRNV 2,5X75 | | 131 |
| 3565002104 | ELKTRO KRGB SET4 | | 112 | 4140174100 | 1000V DÜZ UÇ TRNV 4X100 | | 131 |
| 3800150160 | KRPTN 160 | | 113 | 4140175512 | 1000V DÜZ UÇ TRNV 5,5X125 | | 131 |
| 3800150180 | KRPTN 180 | | 113 | 4140176515 | 1000V DÜZ UÇ TRNV 6,5X150 | | 131 |
| 3800150200 | KRPTN 200 | | 113 | 4140009106 | 1000V DÜZ&YLD UÇ TRNV SET6 | | 131 |
| 3800150250 | KRPTN 250 | | 113 | 4145180360 | 1000V YLD UÇ TRNV 3X60 | | 131 |
| 3830150225 | BTN KRPTN 225 | | 113 | 4145184580 | 1000V YLD UÇ TRNV 4,5X80 | | 131 |
| 3830150250 | BTN KRPTN 250 | | 113 | 4145186100 | 1000V YLD UÇ TRNV 6X100 | | 131 |
| 3830150280 | BTN KRPTN 280 | | 113 | 4300170380 | OPAK DÜZ UÇ TRNV 3X80 | | 132 |
| 3831150280 | BTN KRPTN YAY 280 | | 113 | 4300170480 | OPAK DÜZ UÇ TRNV 4X80 | | 132 |
| 3835150280 | AGR BTN KRPTN 280 | | 113 | 4300174100 | OPAK DÜZ UÇ TRNV 4X100 | | 132 |
| 3850120200 | DNLY 200 | | 113 | 4300175100 | OPAK DÜZ UÇ TRNV 5X100 | | 132 |
| 3020006003 | 1000V ELKT 160 SET3 | | 120 | 4300175125 | OPAK DÜZ UÇ TRNV 5X125 | | 132 |
| 8795006005 | 1000V ELKT SET5 | | 122 | 4300176100 | OPAK DÜZ UÇ TRNV 6X100 | | 132 |
| 8440001023 | TKÇ PLS ELKT SET23 19" | | 122 | 4300176125 | OPAK DÜZ UÇ TRNV 6X125 | | 132 |
| 4550170135 | KNT KLM DÜZ UÇ 135 | | 127 | 4300176150 | OPAK DÜZ UÇ TRNV 6X150 | | 132 |
| 4550170190 | KNT KLM DÜZ UÇ 190 | | 127 | 4300177125 | OPAK DÜZ UÇ TRNV 7X125 | | 132 |
| 4555170165 | MSTR KNT KLM DÜZ UÇ 165 | | 127 | 4300177150 | OPAK DÜZ UÇ TRNV 7X150 | | 132 |
| 4560180135 | KNT KLM YLD UÇ 135 | | 127 | 4300178175 | OPAK DÜZ UÇ TRNV 8X175 | | 132 |
| 4560180190 | KNT KLM YLD UÇ 190 | | 127 | 4300179200 | OPAK DÜZ UÇ TRNV 9X200 | | 132 |
| 4565170135 | OTO KNT KLM 135 | | 127 | 4320180360 | OPAK YLD UÇ TRNV 3X60 | | 132 |
| 4100170340 | KRAFT DÜZ UÇ TRNV 3X40 | | 128 | 4320184580 | OPAK YLD UÇ TRNV 4,5X80 | | 132 |
| 4100170380 | KRAFT DÜZ UÇ TRNV 3X80 | | 128 | 4320186100 | OPAK YLD UÇ TRNV 6X100 | | 132 |
| 4100170480 | KRAFT DÜZ UÇ TRNV 4X80 | | 128 | 4320188150 | OPAK YLD UÇ TRNV 8X150 | | 132 |
| 4100174100 | KRAFT DÜZ UÇ TRNV 4X100 | | 128 | 4300008107 | OPAK DÜZ&YLD UÇ TRNV SET7 | | 132 |
| 4100170580 | KRAFT DÜZ UÇ TRNV 5X80 | | 128 | 4325180360 | OPAK PZ UÇ TRNV 3X60 | | 132 |
| 4100175100 | KRAFT DÜZ UÇ TRNV 5X100 | | 128 | 4325184580 | OPAK PZ UÇ TRNV 4,5X80 | | 132 |
| 4100175125 | KRAFT DÜZ UÇ TRNV 5X125 | | 128 | 4325186100 | OPAK PZ UÇ TRNV 6X100 | | 132 |
| 4100175150 | KRAFT DÜZ UÇ TRNV 5X150 | | 128 | 4325188150 | OPAK PZ UÇ TRNV 8X150 | | 132 |
| 4100176100 | KRAFT DÜZ UÇ TRNV 6X100 | | 128 | 4350170380 | ERGO DÜZ UÇ TRNV 3X80 | | 133 |
| 4100176125 | KRAFT DÜZ UÇ TRNV 6X125 | | 128 | 4350170480 | ERGO DÜZ UÇ TRNV 4X80 | | 133 |
| 4100176150 | KRAFT DÜZ UÇ TRNV 6X150 | | 128 | 4350174100 | ERGO DÜZ UÇ TRNV 4X100 | | 133 |
| 4100176175 | KRAFT DÜZ UÇ TRNV 6X175 | | 128 | 4350175100 | ERGO DÜZ UÇ TRNV 5X100 | | 133 |
| 4100177125 | KRAFT DÜZ UÇ TRNV 7X125 | | 128 | 4350175125 | ERGO DÜZ UÇ TRNV 5X125 | | 133 |
| 4100177150 | KRAFT DÜZ UÇ TRNV 7X150 | | 128 | 4350176100 | ERGO DÜZ UÇ TRNV 6X100 | | 133 |
| 4100177175 | KRAFT DÜZ UÇ TRNV 7X175 | | 128 | 4350176125 | ERGO DÜZ UÇ TRNV 6X125 | | 133 |
| 4100178150 | KRAFT DÜZ UÇ TRNV 8X150 | | 128 | 4350176150 | ERGO DÜZ UÇ TRNV 6X150 | | 133 |
| 4100178175 | KRAFT DÜZ UÇ TRNV 8X175 | | 128 | 4350177125 | ERGO DÜZ UÇ TRNV 7X125 | | 133 |
| 4100178200 | KRAFT DÜZ UÇ TRNV 8X200 | | 128 | 4350177150 | ERGO DÜZ UÇ TRNV 7X150 | | 133 |
| 4100179200 | KRAFT DÜZ UÇ TRNV 9X200 | | 128 | 4350178175 | ERGO DÜZ UÇ TRNV 8X175 | | 133 |
| 4100171125 | KRAFT DÜZ UÇ TRNV 11X250 | | 128 | 4350179200 | ERGO DÜZ UÇ TRNV 9X200 | | 133 |
| 4100008108 | KRAFT DÜZ UÇ TRNV TK8 | | 128 | 4370180360 | ERGO YLD UÇ TRNV 3X60 | | 133 |
| 4100174300 | KRAFT DÜZ UÇ TRNV 4X300 | | 128 | 4370184580 | ERGO YLD UÇ TRNV 4,5X80 | | 133 |
| 4100175250 | KRAFT DÜZ UÇ TRNV 5X250 | | 128 | 4370186100 | ERGO YLD UÇ TRNV 6X100 | | 133 |
| 4100175350 | KRAFT DÜZ UÇ TRNV 5X350 | | 128 | 4370188150 | ERGO YLD UÇ TRNV 8X150 | | 133 |
| 4100176350 | KRAFT DÜZ UÇ TRNV 6X350 | | 128 | 4350008107 | ERGO DÜZ&YLD UÇ TRNV SET7 | | 133 |
| 4120180360 | KRAFT YLD UÇ TRNV 3X60 | | 129 | 4240170680 | DĞŞK UÇ TRNV 6X80 | | 134 |
| 4120184580 | KRAFT YLD UÇ TRNV 4,5X80 | | 129 | 4500172560 | KLMNS DÜZ UÇ TRNV 2,5X60 | | 134 |
| 4120185100 | KRAFT YLD UÇ TRNV 4,5X100 | | 129 | 4500172580 | KLMNS DÜZ UÇ TRNV 2,5X80 | | 134 |
| 4120185150 | KRAFT YLD UÇ TRNV 4,5X150 | | 129 | 4500170380 | KLMNS DÜZ UÇ TRNV 3X80 | | 134 |
| 4120186100 | KRAFT YLD UÇ TRNV 6X100 | | 129 | 4500173100 | KLMNS DÜZ UÇ TRNV 3X100 | | 134 |
| 4120186150 | KRAFT YLD UÇ TRNV 6X150 | | 129 | 4500173125 | KLMNS DÜZ UÇ TRNV 3X125 | | 134 |

| KOD | ÜRÜN | FİYAT | SAYFA | KOD | ÜRÜN | FİYAT | SAYFA |
|------------|----------------------------|-------|-------|------------|-------------------------------------|-------|-------|
| 4500173510 | KLMNS DÜZ UÇ TRNV 3,5X100 | | 134 | 4776180015 | DLK TORX UÇ TRNV TR15 | | 138 |
| 4500170480 | KLMNS DÜZ UÇ TRNV 4X80 | | 134 | 4776180020 | DLK TORX UÇ TRNV TR20 | | 138 |
| 4500174100 | KLMNS DÜZ UÇ TRNV 4X100 | | 134 | 4776180025 | DLK TORX UÇ TRNV TR25 | | 138 |
| 4500174125 | KLMNS DÜZ UÇ TRNV 4X125 | | 134 | 4776180027 | DLK TORX UÇ TRNV TR27 | | 138 |
| 4500174150 | KLMNS DÜZ UÇ TRNV 4X150 | | 134 | 4776180030 | DLK TORX UÇ TRNV TR30 | | 138 |
| 4520180360 | KLMNS YLD UÇ TRNV 3X60 | | 134 | 4776180040 | DLK TORX UÇ TRNV TR40 | | 138 |
| 4520180480 | KLMNS YLD UÇ TRNV 4X80 | | 134 | 4776008107 | DLK TORX UÇ TRNV TK7 | | 138 |
| 4520184150 | KLMNS YLD UÇ TRNV 4X150 | | 134 | 4780196120 | MNY BİTS TUTC TRNV 6,3X120 | | 138 |
| 4240007102 | DĞŞK UÇ TRNV TK2 | | 134 | 4783196120 | 1000V MNY BİTS TUTC TRNV 6,3X120 | | 138 |
| 4500008106 | KLMNS DÜZ&YLD UÇ TRNV SET6 | | 134 | 4785196330 | MNY BİTS TUTC TRNV 6,3X30 | | 138 |
| 4530170560 | KLMNS TORX UÇ TRNV T5 | | 135 | 4790266360 | ÜNV MNY BİTS ADP 6,3X60 | | 138 |
| 4530170660 | KLMNS TORX UÇ TRNV T6 | | 135 | 4795190010 | TTİP MNY BİTS TUTC TRNV 6,3X130 | | 139 |
| 4530170760 | KLMNS TORX UÇ TRNV T7 | | 135 | 4788196160 | MNY BİTS TUTC TRNV FLEX SNG 6,3X160 | | 139 |
| 4530170860 | KLMNS TORX UÇ TRNV T8 | | 135 | 4805205010 | 1/4"M-1/4"M BİTS UÇ LKM ADP | | 139 |
| 4530170960 | KLMNS TORX UÇ TRNV T9 | | 135 | 4805205011 | 1/4"M-1/2"M BİTS UÇ LKM ADP | | 139 |
| 4530171060 | KLMNS TORX UÇ TRNV T10 | | 135 | 4815006107 | DĞŞK BİTS UÇ TRNV SET7 | | 139 |
| 4530001006 | KLMNS TORX UÇ TRNV TK6 | | 135 | 4800008106 | BİTS UÇ SET6 (25) | | 139 |
| 4540190190 | KLİPS SÖKM TRNV | | 135 | 4800008110 | BİTS UÇ SET10 (25) | | 139 |
| 4765190040 | TTİP LKM UÇ TRNV 04 | | 136 | 4800008131 | BİTS UÇ PLS KUTU SET31 | | 139 |
| 4765190050 | TTİP LKM UÇ TRNV 05 | | 136 | 4810200645 | DÜZ BİTS UÇ 0,6X4,5 (25) | | 140 |
| 4765190055 | TTİP LKM UÇ TRNV 5,5 | | 136 | 4810200855 | DÜZ BİTS UÇ 0,8X5,5 (25) | | 140 |
| 4765190060 | TTİP LKM UÇ TRNV 06 | | 136 | 4810201265 | DÜZ BİTS UÇ 1,2X6,5 (25) | | 140 |
| 4765190070 | TTİP LKM UÇ TRNV 07 | | 136 | 4810205645 | DÜZ BİTS UÇ 0,6X4,5 (50) | | 140 |
| 4765190080 | TTİP LKM UÇ TRNV 08 | | 136 | 4810205855 | DÜZ BİTS UÇ 0,8X5,5 (50) | | 140 |
| 4765190090 | TTİP LKM UÇ TRNV 09 | | 136 | 4810205265 | DÜZ BİTS UÇ 1,2X6,5 (50) | | 140 |
| 4765190100 | TTİP LKM UÇ TRNV 10 | | 136 | 4860200745 | DÜZ BİTS UÇ 4,5 (75) | | 140 |
| 4765190110 | TTİP LKM UÇ TRNV 11 | | 136 | 4860200755 | DÜZ BİTS UÇ 5,5 (75) | | 140 |
| 4765190120 | TTİP LKM UÇ TRNV 12 | | 136 | 4860200765 | DÜZ BİTS UÇ 6,5 (75) | | 140 |
| 4765190130 | TTİP LKM UÇ TRNV 13 | | 136 | 4860201045 | DÜZ BİTS UÇ 4,5 (100) | | 140 |
| 4765190140 | TTİP LKM UÇ TRNV 14 | | 136 | 4860201055 | DÜZ BİTS UÇ 5,5 (100) | | 140 |
| 4770190040 | LKM UÇ TRNV 04 | | 136 | 4860201065 | DÜZ BİTS UÇ 6,5 (100) | | 140 |
| 4770190050 | LKM UÇ TRNV 05 | | 136 | 4860201545 | DÜZ BİTS UÇ 4,5 (150) | | 140 |
| 4770190055 | LKM UÇ TRNV 5,5 | | 136 | 4860201555 | DÜZ BİTS UÇ 5,5 (150) | | 140 |
| 4770190060 | LKM UÇ TRNV 06 | | 136 | 4860201565 | DÜZ BİTS UÇ 6,5 (150) | | 140 |
| 4770190070 | LKM UÇ TRNV 07 | | 136 | 4810000645 | DÜZ BİTS UÇ TK10 0,6X4,5 | | 140 |
| 4770190080 | LKM UÇ TRNV 08 | | 136 | 4810000855 | DÜZ BİTS UÇ TK10 0,8X5,5 | | 140 |
| 4770190090 | LKM UÇ TRNV 09 | | 136 | 4810001265 | DÜZ BİTS UÇ TK10 1,2X6,5 | | 140 |
| 4770190100 | LKM UÇ TRNV 10 | | 136 | 4820210001 | YLD BİTS UÇ PH1 (25) | | 140 |
| 4770190110 | LKM UÇ TRNV 11 | | 136 | 4820210002 | YLD BİTS UÇ PH2 (25) | | 140 |
| 4770190120 | LKM UÇ TRNV 12 | | 136 | 4820210003 | YLD BİTS UÇ PH3 (25) | | 140 |
| 4770190130 | LKM UÇ TRNV 13 | | 136 | 4820210011 | YLD BİTS UÇ PH1 (50) | | 140 |
| 4770190140 | LKM UÇ TRNV 14 | | 136 | 4820210012 | YLD BİTS UÇ PH2 (50) | | 140 |
| 4770008108 | LKM UÇ TRNV TK8 | | 136 | 4820210013 | YLD BİTS UÇ PH3 (50) | | 140 |
| 4773190040 | 1000V LKM UÇ TRNV 04 | | 137 | 4870210701 | YLD BİTS UÇ PH1 (75) | | 140 |
| 4773190050 | 1000V LKM UÇ TRNV 05 | | 137 | 4870210702 | YLD BİTS UÇ PH2 (75) | | 140 |
| 4773190055 | 1000V LKM UÇ TRNV 5,5 | | 137 | 4870210703 | YLD BİTS UÇ PH3 (75) | | 140 |
| 4773190060 | 1000V LKM UÇ TRNV 06 | | 137 | 4870211001 | YLD BİTS UÇ PH1 (100) | | 140 |
| 4773190070 | 1000V LKM UÇ TRNV 07 | | 137 | 4870211002 | YLD BİTS UÇ PH2 (100) | | 140 |
| 4773190080 | 1000V LKM UÇ TRNV 08 | | 137 | 4870211003 | YLD BİTS UÇ PH3 (100) | | 140 |
| 4773190090 | 1000V LKM UÇ TRNV 09 | | 137 | 4870211501 | YLD BİTS UÇ PH1 (150) | | 140 |
| 4773190100 | 1000V LKM UÇ TRNV 10 | | 137 | 4870211502 | YLD BİTS UÇ PH2 (150) | | 140 |
| 4773190110 | 1000V LKM UÇ TRNV 11 | | 137 | 4870211503 | YLD BİTS UÇ PH3 (150) | | 140 |
| 4773190120 | 1000V LKM UÇ TRNV 12 | | 137 | 4820000001 | YLD BİTS UÇ TK10 PH1 (25) | | 140 |
| 4773190130 | 1000V LKM UÇ TRNV 13 | | 137 | 4820000002 | YLD BİTS UÇ TK10 PH2 (25) | | 140 |
| 4773190140 | 1000V LKM UÇ TRNV 14 | | 137 | 4820000003 | YLD BİTS UÇ TK10 PH3 (25) | | 140 |
| 4773008108 | 1000V LKM UÇ TRNV TK8 | | 137 | 4825210001 | PZ1 BİTS UÇ (25) | | 141 |
| 4775180010 | TORX UÇ TRNV T10 | | 137 | 4825210002 | PZ2 BİTS UÇ (25) | | 141 |
| 4775180015 | TORX UÇ TRNV T15 | | 137 | 4825210003 | PZ3 BİTS UÇ (25) | | 141 |
| 4775180020 | TORX UÇ TRNV T20 | | 137 | 4825210011 | PZ1 BİTS UÇ (50) | | 141 |
| 4775180025 | TORX UÇ TRNV T25 | | 137 | 4825210012 | PZ2 BİTS UÇ (50) | | 141 |
| 4775180027 | TORX UÇ TRNV T27 | | 137 | 4825210013 | PZ3 BİTS UÇ (50) | | 141 |
| 4775180030 | TORX UÇ TRNV T30 | | 137 | 4880210701 | PZ1 BİTS UÇ (75) | | 141 |
| 4775180040 | TORX UÇ TRNV T40 | | 137 | 4880210702 | PZ2 BİTS UÇ (75) | | 141 |
| 4775180045 | TORX UÇ TRNV T45 | | 137 | 4880210703 | PZ3 BİTS UÇ (75) | | 141 |
| 4775008107 | TORX UÇ TRNV TK7 | | 137 | 4880211001 | PZ1 BİTS UÇ (100) | | 141 |
| 4776180009 | DLK TORX UÇ TRNV TR9 | | 138 | 4880211002 | PZ2 BİTS UÇ (100) | | 141 |
| 4776180010 | DLK TORX UÇ TRNV TR10 | | 138 | 4880211003 | PZ3 BİTS UÇ (100) | | 141 |

| KOD | ÜRÜN | FİYAT | SAYFA | KOD | ÜRÜN | FİYAT | SAYFA |
|------------|------------------------------|-------|-------|------------|--------------------------------|-------|-------|
| 4880211501 | PZ1 BİTS UÇ (150) | | 141 | 4901221587 | 6KŞ ALLEN ANH 5/8 SAE | | 143 |
| 4880211502 | PZ2 BİTS UÇ (150) | | 141 | 4901221905 | 6KŞ ALLEN ANH 3/4 SAE | | 143 |
| 4880211503 | PZ3 BİTS UÇ (150) | | 141 | 4901003110 | 6KŞ ALLEN ANH TK10 SAE | | 143 |
| 4825000001 | PZ1 BİTS UÇ TK10 (25) | | 141 | 4901003112 | 6KŞ ALLEN ANH TK12 SAE | | 143 |
| 4825000002 | PZ2 BİTS UÇ TK10 (25) | | 141 | 4903220020 | 6KŞ ALLEN ANH UB 02 | | 144 |
| 4825000003 | PZ3 BİTS UÇ TK10 (25) | | 141 | 4903220025 | 6KŞ ALLEN ANH UB 2,5 | | 144 |
| 4830210025 | TORX BİTS UÇ T25 (25) | | 141 | 4903220030 | 6KŞ ALLEN ANH UB 03 | | 144 |
| 4830210027 | TORX BİTS UÇ T27 (25) | | 141 | 4903220035 | 6KŞ ALLEN ANH UB 3,5 | | 144 |
| 4830210030 | TORX BİTS UÇ T30 (25) | | 141 | 4903220040 | 6KŞ ALLEN ANH UB 04 | | 144 |
| 4830210040 | TORX BİTS UÇ T40 (25) | | 141 | 4903220050 | 6KŞ ALLEN ANH UB 05 | | 144 |
| 4830210125 | TORX BİTS UÇ T25 (50) | | 141 | 4903220060 | 6KŞ ALLEN ANH UB 06 | | 144 |
| 4830210127 | TORX BİTS UÇ T27 (50) | | 141 | 4903220070 | 6KŞ ALLEN ANH UB 07 | | 144 |
| 4830210130 | TORX BİTS UÇ T30 (50) | | 141 | 4903220080 | 6KŞ ALLEN ANH UB 08 | | 144 |
| 4830210140 | TORX BİTS UÇ T40 (50) | | 141 | 4903220090 | 6KŞ ALLEN ANH UB 09 | | 144 |
| 4885210725 | TORX BİTS UÇ T25 (75) | | 141 | 4903220100 | 6KŞ ALLEN ANH UB 10 | | 144 |
| 4885210727 | TORX BİTS UÇ T27 (75) | | 141 | 4903220120 | 6KŞ ALLEN ANH UB 12 | | 144 |
| 4885210730 | TORX BİTS UÇ T30 (75) | | 141 | 4903220140 | 6KŞ ALLEN ANH UB 14 | | 144 |
| 4885210740 | TORX BİTS UÇ T40 (75) | | 141 | 4903220160 | 6KŞ ALLEN ANH UB 16 | | 144 |
| 4885211025 | TORX BİTS UÇ T25 (100) | | 141 | 4903220170 | 6KŞ ALLEN ANH UB 17 | | 144 |
| 4885211027 | TORX BİTS UÇ T27 (100) | | 141 | 4903220190 | 6KŞ ALLEN ANH UB 19 | | 144 |
| 4885211030 | TORX BİTS UÇ T30 (100) | | 141 | 4903003110 | 6KŞ ALLEN ANH UB TK10 | | 144 |
| 4885211040 | TORX BİTS UÇ T40 (100) | | 141 | 4903003112 | 6KŞ ALLEN ANH UB TK12 | | 144 |
| 4885211525 | TORX BİTS UÇ T25 (150) | | 141 | 4905220020 | 6KŞ YVRL BAŞL ALLEN ANH KB 02 | | 144 |
| 4885211527 | TORX BİTS UÇ T27 (150) | | 141 | 4905220025 | 6KŞ YVRL BAŞL ALLEN ANH KB 2,5 | | 144 |
| 4885211530 | TORX BİTS UÇ T30 (150) | | 141 | 4905220030 | 6KŞ YVRL BAŞL ALLEN ANH KB 03 | | 144 |
| 4885211540 | TORX BİTS UÇ T40 (150) | | 141 | 4905220040 | 6KŞ YVRL BAŞL ALLEN ANH KB 04 | | 144 |
| 4830000025 | TORX BİTS UÇ T25 TK10 (25) | | 141 | 4905220050 | 6KŞ YVRL BAŞL ALLEN ANH KB 05 | | 144 |
| 4830000027 | TORX BİTS UÇ T27 TK10 (25) | | 141 | 4905220060 | 6KŞ YVRL BAŞL ALLEN ANH KB 06 | | 144 |
| 4830000030 | TORX BİTS UÇ T30 TK10 (25) | | 141 | 4905220080 | 6KŞ YVRL BAŞL ALLEN ANH KB 08 | | 144 |
| 4830000040 | TORX BİTS UÇ T40 TK10 (25) | | 141 | 4905220100 | 6KŞ YVRL BAŞL ALLEN ANH KB 10 | | 144 |
| 4784196346 | 1/4" BİTS TUTC TRNV AVUÇ İÇİ | | 142 | 4905007108 | 6KŞ YVRL BAŞL ALLEN ANH KB TK8 | | 144 |
| 4850000713 | BİTS UÇ SET13 (75) | | 142 | 4906220015 | 6KŞ YVRL BAŞL ALLEN ANH UB 1,5 | | 145 |
| 4850001013 | BİTS UÇ SET13 (100) | | 142 | 4906220020 | 6KŞ YVRL BAŞL ALLEN ANH UB 02 | | 145 |
| 4850001513 | BİTS UÇ SET13 (150) | | 142 | 4906220025 | 6KŞ YVRL BAŞL ALLEN ANH UB 2,5 | | 145 |
| 4900220015 | 6KŞ ALLEN ANH 1,5 | | 143 | 4906220030 | 6KŞ YVRL BAŞL ALLEN ANH UB 03 | | 145 |
| 4900220020 | 6KŞ ALLEN ANH KB 02 | | 143 | 4906220040 | 6KŞ YVRL BAŞL ALLEN ANH UB 04 | | 145 |
| 4900220025 | 6KŞ ALLEN ANH KB 2,5 | | 143 | 4906220050 | 6KŞ YVRL BAŞL ALLEN ANH UB 05 | | 145 |
| 4900220030 | 6KŞ ALLEN ANH KB 03 | | 143 | 4906220060 | 6KŞ YVRL BAŞL ALLEN ANH UB 06 | | 145 |
| 4900220035 | 6KŞ ALLEN ANH KB 3,5 | | 143 | 4906220080 | 6KŞ YVRL BAŞL ALLEN ANH UB 08 | | 145 |
| 4900220040 | 6KŞ ALLEN ANH KB 04 | | 143 | 4906220100 | 6KŞ YVRL BAŞL ALLEN ANH UB 10 | | 145 |
| 4900220050 | 6KŞ ALLEN ANH KB 05 | | 143 | 4906003109 | 6KŞ YVRL BAŞL ALLEN ANH UB TK9 | | 145 |
| 4900220060 | 6KŞ ALLEN ANH KB 06 | | 143 | 4910220006 | TORX ALLEN ANH T6 | | 145 |
| 4900220070 | 6KŞ ALLEN ANH KB 07 | | 143 | 4910220007 | TORX ALLEN ANH T7 | | 145 |
| 4900220080 | 6KŞ ALLEN ANH KB 08 | | 143 | 4910220008 | TORX ALLEN ANH T8 | | 145 |
| 4900220090 | 6KŞ ALLEN ANH KB 09 | | 143 | 4910220009 | TORX ALLEN ANH T9 | | 145 |
| 4900220100 | 6KŞ ALLEN ANH KB 10 | | 143 | 4910220010 | TORX ALLEN ANH T10 | | 145 |
| 4900220120 | 6KŞ ALLEN ANH KB 12 | | 143 | 4910220015 | TORX ALLEN ANH T15 | | 145 |
| 4900220140 | 6KŞ ALLEN ANH KB 14 | | 143 | 4910220020 | TORX ALLEN ANH T20 | | 145 |
| 4900220160 | 6KŞ ALLEN ANH KB 16 | | 143 | 4910220025 | TORX ALLEN ANH T25 | | 145 |
| 4900220170 | 6KŞ ALLEN ANH KB 17 | | 143 | 4910220027 | TORX ALLEN ANH T27 | | 145 |
| 4900220190 | 6KŞ ALLEN ANH KB 19 | | 143 | 4910220030 | TORX ALLEN ANH T30 | | 145 |
| 4900220220 | 6KŞ ALLEN ANH KB 22 | | 143 | 4910220040 | TORX ALLEN ANH T40 | | 145 |
| 4900220240 | 6KŞ ALLEN ANH KB 24 | | 143 | 4910220045 | TORX ALLEN ANH T45 | | 145 |
| 4900003110 | 6KŞ ALLEN ANH KB TK10 | | 143 | 4910220050 | TORX ALLEN ANH T50 | | 145 |
| 4900003112 | 6KŞ ALLEN ANH KB TK12 | | 143 | 4910220055 | TORX ALLEN ANH T55 | | 145 |
| 4901221984 | 6KŞ ALLEN ANH 5/64 SAE | | 143 | 4910220060 | TORX ALLEN ANH T60 | | 145 |
| 4901222381 | 6KŞ ALLEN ANH 3/32 SAE | | 143 | 4910007108 | TORX ALLEN ANH TK8 | | 145 |
| 4901223125 | 6KŞ ALLEN ANH 1/8 SAE | | 143 | 4912003107 | KST ALLEN ANH 2,5-10 | | 146 |
| 4901223968 | 6KŞ ALLEN ANH 5/32 SAE | | 143 | 4912000007 | KST ALLEN ANH 1,5-6 | | 146 |
| 4901224762 | 6KŞ ALLEN ANH 3/16 SAE | | 143 | 4909220009 | TTİP TORX ALLEN ANH T9 | | 146 |
| 4901225556 | 6KŞ ALLEN ANH 7/32 SAE | | 143 | 4909220010 | TTİP TORX ALLEN ANH T10 | | 146 |
| 4901226350 | 6KŞ ALLEN ANH 1/4 SAE | | 143 | 4909220015 | TTİP TORX ALLEN ANH T15 | | 146 |
| 4901227937 | 6KŞ ALLEN ANH 5/16 SAE | | 143 | 4909220020 | TTİP TORX ALLEN ANH T20 | | 146 |
| 4901229825 | 6KŞ ALLEN ANH 3/8 SAE | | 143 | 4909220025 | TTİP TORX ALLEN ANH T25 | | 146 |
| 4901221111 | 6KŞ ALLEN ANH 7/16 SAE | | 143 | 4909220027 | TTİP TORX ALLEN ANH T27 | | 146 |
| 4901221270 | 6KŞ ALLEN ANH 1/2 SAE | | 143 | 4909220030 | TTİP TORX ALLEN ANH T30 | | 146 |
| 4901221428 | 6KŞ ALLEN ANH 9/16 SAE | | 143 | 4909220040 | TTİP TORX ALLEN ANH T40 | | 146 |

| KOD | ÜRÜN | FİYAT | SAYFA | KOD | ÜRÜN | FİYAT | SAYFA |
|------------|----------------------------------|-------|-------|------------|--------------------------------|-------|-------|
| 4909008108 | TTİP TORX ALLEN ANH TK8 | | 146 | 5550240009 | DÜZ PİM ZMB 09 | | 152 |
| 4920220025 | TTİP 6KŞ ALLEN ANH 2,5 | | 147 | 5550240010 | DÜZ PİM ZMB 10 | | 152 |
| 4920220030 | TTİP 6KŞ ALLEN ANH 03 | | 147 | 5550240105 | DÜZ PİM ZMB KKPL 05 | | 152 |
| 4920220040 | TTİP 6KŞ ALLEN ANH 04 | | 147 | 5550001006 | DÜZ PİM ZMB TK6 | | 153 |
| 4920220050 | TTİP 6KŞ ALLEN ANH 05 | | 147 | 5600006106 | KSK&ZMB SET6 | | 153 |
| 4920220060 | TTİP 6KŞ ALLEN ANH 06 | | 147 | 5700240003 | KYŞ ZMB 03 | | 153 |
| 4920220070 | TTİP 6KŞ ALLEN ANH 07 | | 147 | 5700240004 | KYŞ ZMB 04 | | 153 |
| 4920220080 | TTİP 6KŞ ALLEN ANH 08 | | 147 | 5700240005 | KYŞ ZMB 05 | | 153 |
| 4920220100 | TTİP 6KŞ ALLEN ANH 10 | | 147 | 5700240006 | KYŞ ZMB 06 | | 153 |
| 4920008108 | TTİP 6KŞ ALLEN ANH TK8 | | 147 | 5700240007 | KYŞ ZMB 07 | | 153 |
| 4921220025 | TTİP 6KŞ YVRL BAŞL ALLEN ANH 2,5 | | 147 | 5700240008 | KYŞ ZMB 08 | | 153 |
| 4921220030 | TTİP 6KŞ YVRL BAŞL ALLEN ANH 03 | | 147 | 5700240009 | KYŞ ZMB 09 | | 153 |
| 4921220040 | TTİP 6KŞ YVRL BAŞL ALLEN ANH 04 | | 147 | 5700240010 | KYŞ ZMB 10 | | 153 |
| 4921220050 | TTİP 6KŞ YVRL BAŞL ALLEN ANH 05 | | 147 | 5700240011 | KYŞ ZMB 11 | | 153 |
| 4921220060 | TTİP 6KŞ YVRL BAŞL ALLEN ANH 06 | | 147 | 5700240012 | KYŞ ZMB 12 | | 153 |
| 4921220070 | TTİP 6KŞ YVRL BAŞL ALLEN ANH 07 | | 147 | 5700240013 | KYŞ ZMB 13 | | 153 |
| 4921220080 | TTİP 6KŞ YVRL BAŞL ALLEN ANH 08 | | 147 | 5700240014 | KYŞ ZMB 14 | | 153 |
| 4921220100 | TTİP 6KŞ YVRL BAŞL ALLEN ANH 10 | | 147 | 5700240015 | KYŞ ZMB 15 | | 153 |
| 4921008108 | TTİP 6KŞ YVRL BAŞL ALLEN ANH TK8 | | 147 | 5700240016 | KYŞ ZMB 16 | | 153 |
| 5010230006 | ISKPL DÜZ 06 | | 151 | 5700240017 | KYŞ ZMB 17 | | 153 |
| 5010230008 | ISKPL DÜZ 08 | | 151 | 5700240018 | KYŞ ZMB 18 | | 153 |
| 5010230010 | ISKPL DÜZ 10 | | 151 | 5700240019 | KYŞ ZMB 19 | | 153 |
| 5010230012 | ISKPL DÜZ 12 | | 151 | 5700240020 | KYŞ ZMB 20 | | 153 |
| 5010230014 | ISKPL DÜZ 14 | | 151 | 5700002110 | KYŞ ZMB TK10 | | 153 |
| 5010230016 | ISKPL DÜZ 16 | | 151 | 5700002112 | KYŞ ZMB TK12 | | 153 |
| 5010230018 | ISKPL DÜZ 18 | | 151 | 5800250100 | TSVY ÇKÇ 100GR | | 154 |
| 5010230020 | ISKPL DÜZ 20 | | 151 | 5800250200 | TSVY ÇKÇ 200GR | | 154 |
| 5010230022 | ISKPL DÜZ 22 | | 151 | 5800250300 | TSVY ÇKÇ 300GR | | 154 |
| 5010230024 | ISKPL DÜZ 24 | | 151 | 5800250500 | TSVY ÇKÇ 500GR | | 154 |
| 5010230026 | ISKPL DÜZ 26 | | 151 | 5800251000 | TSVY ÇKÇ 1000GR | | 154 |
| 5010230030 | ISKPL DÜZ 30 | | 151 | 5800251500 | TSVY ÇKÇ 1500GR | | 154 |
| 5010008106 | ISKPL TK6 | | 151 | 5800252000 | TSVY ÇKÇ 2000GR | | 154 |
| 5500230100 | DÜZ KSK 100 | | 151 | 5810251000 | EMNY ÇKÇ 1000GR | | 154 |
| 5500230125 | DÜZ KSK 125 | | 151 | 5810251500 | EMNY ÇKÇ 1500GR | | 154 |
| 5500230150 | DÜZ KSK 150 | | 151 | 5810252000 | EMNY ÇKÇ 2000GR | | 154 |
| 5500230175 | DÜZ KSK 175 | | 151 | 5850250030 | PLS ÇKÇ 30 | | 154 |
| 5500230200 | DÜZ KSK 200 | | 151 | 5850250040 | PLS ÇKÇ 40 | | 154 |
| 5500230250 | DÜZ KSK 250 | | 151 | 5850250050 | PLS ÇKÇ 50 | | 154 |
| 5500230300 | DÜZ KSK 300 | | 151 | 5870250400 | LSTK ÇKÇ 400GR | | 154 |
| 5500231250 | DÜZ KSK KLKN İZL 250 | | 151 | 5865251000 | MDRG 1000GR | | 155 |
| 5500231300 | DÜZ KSK KLKN İZL 300 | | 151 | 5865251500 | MDRG 1500GR | | 155 |
| 5510230125 | TSVY DÜZ KSK 125 | | 152 | 6410250800 | NCK 800GR | | 155 |
| 5510230150 | TSVY DÜZ KSK 150 | | 152 | 6400250600 | KSR 400GR | | 155 |
| 5520230125 | TRN KSK 130 | | 152 | 6401250600 | USTA KSR 400GR | | 155 |
| 5520230150 | TRN KSK 150 | | 152 | 375050020 | KBLO SYRC 8-28 | | 159 |
| 5540244120 | NKT ZMB 4X120 | | 152 | 375250625 | KBLO SYRC (T 6/300 - Ç 1,5/25) | | 159 |
| 5540245120 | NKT ZMB 5X120 | | 152 | 375150012 | KOAK KBLO SYRC | | 159 |
| 5540245150 | NKT ZMB 5X150 | | 152 | 375350054 | MKNK KBLO SYRC 0,5-4 | | 159 |
| 5540240412 | NKT ZMB KKPL 4X120 | | 152 | 588150013 | KROM ŞRT MT3 | | 159 |
| 5545240002 | KNK PİM ZMB 02 | | 152 | 588150015 | KROM ŞRT MT5 | | 159 |
| 5545240003 | KNK PİM ZMB 03 | | 152 | 588150003 | PLS ŞRT MT3 | | 159 |
| 5545240004 | KNK PİM ZMB 04 | | 152 | 588150005 | PLS ŞRT MT5 | | 159 |
| 5545240005 | KNK PİM ZMB 05 | | 152 | 588650020 | ARZTİP FIB ŞRT SAPLI MT20 | | 160 |
| 5545240006 | KNK PİM ZMB 06 | | 152 | 588650030 | ARZTİP FIB ŞRT SAPLI MT30 | | 160 |
| 5545240007 | KNK PİM ZMB 07 | | 152 | 588650050 | ARZTİP FIB ŞRT SAPLI MT50 | | 160 |
| 5545240008 | KNK PİM ZMB 08 | | 152 | 588050040 | SU TRZ 40CM | | 160 |
| 5545240009 | KNK PİM ZMB 09 | | 152 | 588050050 | SU TRZ 50CM | | 160 |
| 5545240010 | KNK PİM ZMB 10 | | 152 | 588050060 | SU TRZ 60CM | | 160 |
| 5545240012 | KNK PİM ZMB 12 | | 152 | 588050070 | SU TRZ 70CM | | 160 |
| 5545240103 | KNK PİM ZMB KKPL 03 | | 152 | 588050080 | SU TRZ 80CM | | 160 |
| 5550240002 | DÜZ PİM ZMB 02 | | 152 | 588050100 | SU TRZ 100CM | | 160 |
| 5550240003 | DÜZ PİM ZMB 03 | | 152 | 588050120 | SU TRZ 120CM | | 160 |
| 5550240004 | DÜZ PİM ZMB 04 | | 152 | 588050150 | SU TRZ 150CM | | 160 |
| 5550240005 | DÜZ PİM ZMB 05 | | 152 | 588050200 | SU TRZ 200CM | | 160 |
| 5550240006 | DÜZ PİM ZMB 06 | | 152 | 588750150 | KMPS 150 | | 160 |
| 5550240007 | DÜZ PİM ZMB 07 | | 152 | 589050830 | TSTR KOL 30CM | | 160 |
| 5550240008 | DÜZ PİM ZMB 08 | | 152 | 6735270300 | BDM TSTR 300 | | 160 |

| KOD | ÜRÜN | FİYAT | SAYFA | KOD | ÜRÜN | FİYAT | SAYFA |
|------------|-------------------------------|-------|-------|------------|-----------------------------|-------|-------|
| 590150020 | SENTİL 0,05-1 | | 161 | 6211270275 | KPRT MKS 275 SOL YAY | | 172 |
| 590250020 | SENTİL 2-35/1000 SAE | | 161 | 6211270300 | KPRT MKS 300 SOL YAY | | 172 |
| 6195260260 | PRÇN TBNC | | 161 | 6820270200 | TNK MKS 200 | | 172 |
| 6220260500 | SPRL MIKN 500GR | | 161 | 6820270250 | TNK MKS 250 | | 172 |
| 6220261000 | SPRL MIKN 1000GR | | 161 | 6820270300 | TNK MKS 300 | | 172 |
| 6225260200 | MDN YAĞ FLEX UÇ 200CC | | 161 | 6821270250 | TNK MKS YAY 250 | | 172 |
| 6225260300 | MDN YAĞ FLEX UÇ 300CC | | 161 | 6821270300 | TNK MKS YAY 300 | | 172 |
| 6225260500 | MDN YAĞ FLEX UÇ 500CC | | 161 | 6800270180 | KYM MKS DÜZ 180 | | 173 |
| 6230260300 | GRES POMP KAVAL BORU 300CC | | 163 | 6801270180 | KYM MKS EĞRİ 180 | | 173 |
| 6230260500 | GRES POMP KAVAL BORU 500CC | | 163 | 6815270200 | TEL KSM MKS 200 | | 173 |
| 6240260810 | 2A TAPA ANH 08X10 | | 163 | 6740270140 | KMB MKS 140 | | 173 |
| 6350260300 | LVY OLK 300 | | 163 | 6740270190 | KMB MKS 190 | | 173 |
| 6350260400 | LVY OLK 400 | | 163 | 6710270230 | BAĞ MKS LUX 230 | | 174 |
| 6350260500 | LVY OLK 500 | | 163 | 6715270225 | BAĞ MKS COMF 225 | | 174 |
| 6350260600 | LVY OLK 600 | | 163 | 6720270220 | BAĞ MKS HAF 220 | | 174 |
| 6360260600 | LVY OLK KVRK UÇ 600 | | 163 | 6712270210 | ELMA MKS 210 | | 174 |
| 6370260100 | YAĞ FLT SÖKM 100 | | 163 | 676050042 | PLS BORU KSM MKS 42 | | 175 |
| 6375266512 | 2YÖN 3AYK YAĞ FLT SÖKM 65-120 | | 164 | 676050063 | PLS BORU KSM MKS 63 | | 175 |
| 6380266016 | 2ZNCR YAĞ FLT SÖKM 60-16 | | 164 | 6850280322 | KÇK BORU KSC | | 175 |
| 637350140 | KYŞ YAĞ FLT SÖKM 60-140 | | 164 | 6855280330 | STD BORU KSC | | 175 |
| 637450140 | ZNCR YAĞ FLT SÖKM 60-140 | | 164 | 6860280635 | TLSK BORU KSC | | 175 |
| 637550100 | AYR YAĞ FLT SÖKM 100 | | 164 | 6865281050 | PROF BORU KSC | | 175 |
| 639050125 | SGM ÇMBR 125 | | 165 | 7010290810 | STD ÇEK 2KOL 8X10 | | 179 |
| 639050175 | SGM ÇMBR 175 | | 165 | 7010291210 | STD ÇEK 2KOL 12X10 | | 179 |
| 741550003 | 3 SRL TEL FRÇ | | 165 | 7010291615 | STD ÇEK 2KOL 16X15 | | 179 |
| 741550004 | 4 SRL TEL FRÇ | | 165 | 7010292015 | STD ÇEK 2KOL 20X15 | | 179 |
| 741550005 | 5 SRL TEL FRÇ | | 165 | 7010292520 | STD ÇEK 2KOL 25X20 | | 179 |
| 741550006 | 6 SRL TEL FRÇ | | 165 | 7010293520 | STD ÇEK 2KOL 35X20 | | 179 |
| 741650001 | KVRK UÇ FRÇ PLS SAP 270 | | 165 | 7010295220 | STD ÇEK 2KOL 52X20 | | 179 |
| 741050010 | MKR UZT KBLO MT10 | | 165 | 7010006105 | ÇEK&SHP SET6 | | 179 |
| 741050025 | MKR UZT KBLO MT25 | | 165 | 7020293720 | STD ÇEK 3KOL 37X20 | | 179 |
| 741050050 | MKR UZT KBLO MT50 | | 165 | 7020295220 | STD ÇEK 3KOL 52X20 | | 179 |
| 7401300100 | MNGN DNR TBL 100 | | 167 | 7030290808 | MSTR ÇEK 2KOL 8X8 | | 180 |
| 7401300125 | MNGN DNR TBL 125 | | 167 | 7030291212 | MSTR ÇEK 2KOL 12X12 | | 180 |
| 7401300150 | MNGN DNR TBL 150 | | 167 | 7030291616 | MSTR ÇEK 2KOL 16X16 | | 180 |
| 7401300175 | MNGN DNR TBL 175 | | 167 | 7030292320 | MSTR ÇEK 2KOL 23X20 | | 180 |
| 7400000100 | MNGN (DNR TBL DHL) 100 | | 167 | 7040290808 | MSTR ÇEK 3KOL 8X8 | | 180 |
| 7400000125 | MNGN (DNR TBL DHL) 125 | | 167 | 7040291212 | MSTR ÇEK 3KOL 12X12 | | 180 |
| 7400000150 | MNGN (DNR TBL DHL) 150 | | 167 | 7040291616 | MSTR ÇEK 3KOL 16X16 | | 180 |
| 7400000175 | MNGN (DNR TBL DHL) 175 | | 167 | 7040292320 | MSTR ÇEK 3KOL 23X20 | | 180 |
| 7400300100 | MNGN 100 | | 167 | 7050290604 | BTR ÇEK 2KOL 6X4 | | 180 |
| 7400300125 | MNGN 125 | | 167 | 7050290606 | BTR ÇEK 2KOL 6X6 | | 180 |
| 7400300150 | MNGN 150 | | 167 | 7050290808 | BTR ÇEK 2KOL 8X8 | | 180 |
| 7400300175 | MNGN 175 | | 167 | 7060290604 | BTR ÇEK 3KOL 6X4 | | 180 |
| 7300303012 | İŞKN 30X12 | | 168 | 7060290606 | BTR ÇEK 3KOL 6X6 | | 180 |
| 7300304012 | İŞKN 40X12 | | 168 | 7060290808 | BTR ÇEK 3KOL 8X8 | | 180 |
| 7300305012 | İŞKN 50X12 | | 168 | 7070292013 | STİP ÇEK 2KOL 20X13 | | 181 |
| 7300306012 | İŞKN 60X12 | | 168 | 7080292013 | STİP ÇEK 3KOL 20X13 | | 181 |
| 7300308012 | İŞKN 80X12 | | 168 | 7090292222 | ÜNV ÇEK 2KOL 22X22 | | 181 |
| 7300301012 | İŞKN 100X12 | | 168 | 7100292222 | ÜNV ÇEK 3KOL 22X22 | | 181 |
| 7310301005 | KÇK İŞKN 10X5 | | 168 | 7120290507 | İÇ RLM ÇEK PENS 5-7 MDL-A | | 182 |
| 7310301505 | KÇK İŞKN 15X5 | | 168 | 7120290709 | İÇ RLM ÇEK PENS 7-9 MDL-A | | 182 |
| 7310302005 | KÇK İŞKN 20X5 | | 168 | 7120290912 | İÇ RLM ÇEK PENS 9-12 MDL-A | | 182 |
| 7310302505 | KÇK İŞKN 25X5 | | 168 | 7120291013 | İÇ RLM ÇEK PENS 10-13 MDL-A | | 182 |
| 7310303005 | KÇK İŞKN 30X5 | | 168 | 7120291317 | İÇ RLM ÇEK PENS 13-17 MDL-A | | 182 |
| 2350270018 | DMR KSM MKS 18" | | 171 | 7120291419 | İÇ RLM ÇEK PENS 14-19 MDL-A | | 182 |
| 2350270024 | DMR KSM MKS 24" | | 171 | 7120291621 | İÇ RLM ÇEK PENS 16-21 MDL-A | | 182 |
| 2350270030 | DMR KSM MKS 30" | | 171 | 7120291823 | İÇ RLM ÇEK PENS 18-23 MDL-A | | 182 |
| 2350270036 | DMR KSM MKS 36" | | 171 | 7120292025 | İÇ RLM ÇEK PENS 20-25 MDL-A | | 182 |
| 2350006104 | DMR KSM MKS&SHP SET5 | | 171 | 7120292530 | İÇ RLM ÇEK PENS 25-30 MDL-A | | 182 |
| 6205270240 | AL&SAC KSM MKS 240 SAĞ | | 171 | 7120293037 | İÇ RLM ÇEK PENS 30-37 MDL-A | | 182 |
| 6206270240 | AL&SAC KSM MKS 240 SOL | | 171 | 7120293542 | İÇ RLM ÇEK PENS 35-42 MDL-A | | 182 |
| 6207270240 | AL&SAC KSM MKS 240 DÜZ | | 171 | 7120293845 | İÇ RLM ÇEK PENS 38-45 MDL-A | | 182 |
| 6210270250 | KPRT MKS 250 SAĞ YAY | | 172 | 7120294350 | İÇ RLM ÇEK PENS 43-50 MDL-A | | 182 |
| 6210270275 | KPRT MKS 275 SAĞ YAY | | 172 | 7120292540 | İÇ RLM ÇEK PENS 25-40 MDL-B | | 182 |
| 6210270300 | KPRT MKS 300 SAĞ YAY | | 172 | 7120293575 | İÇ RLM ÇEK KOL 35-75 | | 182 |
| 6211270250 | KPRT MKS 250 SOL YAY | | 172 | 7120296013 | İÇ RLM ÇEK KOL 60-130 | | 182 |

| KOD | ÜRÜN | FİYAT | SAYFA | KOD | ÜRÜN | FİYAT | SAYFA |
|------------|-------------------------|-------|-------|------------|------------------------------|-------|-------|
| 7122290560 | DIŞ RLM ÇEK ÇENE 5-60 | | 183 | 450002108 | 2A YLD ANH SB TK8 ELTA | | 188 |
| 7122291275 | DIŞ RLM ÇEK ÇENE 12-75 | | 183 | 450002112 | 2A YLD ANH SB TK12 ELTA | | 188 |
| 7122292211 | DIŞ RLM ÇEK ÇENE 22-115 | | 183 | 601010008 | KURB ANH 8" ELTA | | 188 |
| 7122292515 | DIŞ RLM ÇEK ÇENE 25-155 | | 183 | 601010010 | KURB ANH 10" ELTA | | 188 |
| 7122293022 | DIŞ RLM ÇEK ÇENE 30-220 | | 183 | 601010012 | KURB ANH 12" ELTA | | 188 |
| 7122294028 | DIŞ RLM ÇEK ÇENE 40-280 | | 183 | 1115060010 | 1/2" 6KŞ LKM ANH 10 ELTA | | 189 |
| 7122294011 | DIŞ RLM ÇEK KOL 40-115 | | 183 | 1115060011 | 1/2" 6KŞ LKM ANH 11 ELTA | | 189 |
| 7122295520 | DIŞ RLM ÇEK KOL 55-205 | | 183 | 1115060012 | 1/2" 6KŞ LKM ANH 12 ELTA | | 189 |
| 7122299026 | DIŞ RLM ÇEK KOL 90-260 | | 183 | 1115060013 | 1/2" 6KŞ LKM ANH 13 ELTA | | 189 |
| 7122291036 | DIŞ RLM ÇEK KOL 100-360 | | 183 | 1115060014 | 1/2" 6KŞ LKM ANH 14 ELTA | | 189 |
| 7122291443 | DIŞ RLM ÇEK KOL 140-435 | | 183 | 1115060015 | 1/2" 6KŞ LKM ANH 15 ELTA | | 189 |
| 7126290018 | RTL ÇEK 18 | | 183 | 1115060016 | 1/2" 6KŞ LKM ANH 16 ELTA | | 189 |
| 7126290025 | RTL ÇEK 25 | | 183 | 1115060017 | 1/2" 6KŞ LKM ANH 17 ELTA | | 189 |
| 7126290029 | RTL ÇEK 29 | | 183 | 1115060018 | 1/2" 6KŞ LKM ANH 18 ELTA | | 189 |
| 7126290040 | RTL ÇEK 40 | | 183 | 1115060019 | 1/2" 6KŞ LKM ANH 19 ELTA | | 189 |
| 7126290045 | RTL ÇEK 45 | | 183 | 1115060020 | 1/2" 6KŞ LKM ANH 20 ELTA | | 189 |
| 150010607 | 2A ANH SB 0607 ELTA | | 186 | 1115060021 | 1/2" 6KŞ LKM ANH 21 ELTA | | 189 |
| 150010809 | 2A ANH SB 0809 ELTA | | 186 | 1115060022 | 1/2" 6KŞ LKM ANH 22 ELTA | | 189 |
| 150011011 | 2A ANH SB 1011 ELTA | | 186 | 1115060023 | 1/2" 6KŞ LKM ANH 23 ELTA | | 189 |
| 150011213 | 2A ANH SB 1213 ELTA | | 186 | 1115060024 | 1/2" 6KŞ LKM ANH 24 ELTA | | 189 |
| 150011415 | 2A ANH SB 1415 ELTA | | 186 | 1115060026 | 1/2" 6KŞ LKM ANH 26 ELTA | | 189 |
| 150011617 | 2A ANH SB 1617 ELTA | | 186 | 1115060027 | 1/2" 6KŞ LKM ANH 27 ELTA | | 189 |
| 150011819 | 2A ANH SB 1819 ELTA | | 186 | 1115060028 | 1/2" 6KŞ LKM ANH 28 ELTA | | 189 |
| 150012022 | 2A ANH SB 2022 ELTA | | 186 | 1115060030 | 1/2" 6KŞ LKM ANH 30 ELTA | | 189 |
| 150012123 | 2A ANH SB 2123 ELTA | | 186 | 1115060032 | 1/2" 6KŞ LKM ANH 32 ELTA | | 189 |
| 150012426 | 2A ANH SB 2426 ELTA | | 186 | 1514064025 | 1/2" T KOL 250 ELTA | | 189 |
| 150012528 | 2A ANH SB 2528 ELTA | | 186 | 1514066250 | 1/2" T KOL LKM ADP ELTA | | 189 |
| 150012732 | 2A ANH SB 2732 ELTA | | 186 | 1514064125 | 1/2" ARA KOL 125 ELTA | | 189 |
| 150002108 | 2A ANH SB TK8 ELTA | | 186 | 1514064250 | 1/2" ARA KOL 250 ELTA | | 189 |
| 150002112 | 2A ANH SB TK12 ELTA | | 186 | 1514064065 | 1/2" MFSL 65 ELTA | | 189 |
| 350020006 | KMB ANH SB 06 ELTA | | 187 | 1514065250 | 1/2" CRC KOL 250 ELTA | | 190 |
| 350020007 | KMB ANH SB 07 ELTA | | 187 | 1115002017 | 1/2" 6KŞ LKM ANH SET17 ELTA | | 190 |
| 350020008 | KMB ANH SB 08 ELTA | | 187 | 1115002024 | 1/2" 6KŞ LKM ANH SET24 ELTA | | 190 |
| 350020009 | KMB ANH SB 09 ELTA | | 187 | 2203100010 | 1" MŞL BORU ANH 85 ELTA | | 191 |
| 350020010 | KMB ANH SB 10 ELTA | | 187 | 2203100015 | 1-1/2" MŞL BORU ANH 85 ELTA | | 191 |
| 350020011 | KMB ANH SB 11 ELTA | | 187 | 2203100020 | 2" MŞL BORU ANH 85 ELTA | | 191 |
| 350020012 | KMB ANH SB 12 ELTA | | 187 | 2203100030 | 3" MŞL BORU ANH 85 ELTA | | 191 |
| 350020013 | KMB ANH SB 13 ELTA | | 187 | 2401110240 | FORT PNS 240 ELTA | | 191 |
| 350020014 | KMB ANH SB 14 ELTA | | 187 | 2509110225 | AYR PNS 225 ELTA | | 191 |
| 350020015 | KMB ANH SB 15 ELTA | | 187 | 3021121160 | OPAK KMB PNS 160 ELTA | | 192 |
| 350020016 | KMB ANH SB 16 ELTA | | 187 | 3021121180 | OPAK KMB PNS 180 ELTA | | 192 |
| 350020017 | KMB ANH SB 17 ELTA | | 187 | 3021121200 | OPAK KMB PNS 200 ELTA | | 192 |
| 350020018 | KMB ANH SB 18 ELTA | | 187 | 3221131160 | OPAK DÜZ UÇ KRGB 160 ELTA | | 192 |
| 350020019 | KMB ANH SB 19 ELTA | | 187 | 3221131200 | OPAK DÜZ UÇ KRGB 200 ELTA | | 192 |
| 350020020 | KMB ANH SB 20 ELTA | | 187 | 3701161140 | OPAK YNKS 140 ELTA | | 192 |
| 350020021 | KMB ANH SB 21 ELTA | | 187 | 3701161160 | OPAK YNKS 160 ELTA | | 192 |
| 350020022 | KMB ANH SB 22 ELTA | | 187 | 3801150160 | KRPTN 160 ELTA | | 192 |
| 350020024 | KMB ANH SB 24 ELTA | | 187 | 3801150180 | KRPTN 180 ELTA | | 192 |
| 350020027 | KMB ANH SB 27 ELTA | | 187 | 3801150200 | KRPTN 200 ELTA | | 192 |
| 350020030 | KMB ANH SB 30 ELTA | | 187 | 3832150225 | BTN KRPTN 225 ELTA | | 192 |
| 350020032 | KMB ANH SB 32 ELTA | | 187 | 3832150250 | BTN KRPTN 250 ELTA | | 192 |
| 350002108 | KMB ANH SB TK8 ELTA | | 187 | 3832150280 | BTN KRPTN 280 ELTA | | 192 |
| 350002112 | KMB ANH SB TK12 ELTA | | 187 | 4170170680 | DĞŞK UÇ TRNV 6X80 ELTA | | 192 |
| 350002117 | KMB ANH SB TK17 ELTA | | 187 | 4150170380 | OPAK DÜZ UÇ TRNV 3X80 ELTA | | 193 |
| 350002121 | KMB ANH SB TK21 ELTA | | 187 | 4150170480 | OPAK DÜZ UÇ TRNV 4X80 ELTA | | 193 |
| 450030607 | 2A YLD ANH SB 0607 ELTA | | 188 | 4150174100 | OPAK DÜZ UÇ TRNV 4X100 ELTA | | 193 |
| 450030809 | 2A YLD ANH SB 0809 ELTA | | 188 | 4150175100 | OPAK DÜZ UÇ TRNV 5X100 ELTA | | 193 |
| 450031011 | 2A YLD ANH SB 1011 ELTA | | 188 | 4150175125 | OPAK DÜZ UÇ TRNV 5X125 ELTA | | 193 |
| 450031213 | 2A YLD ANH SB 1213 ELTA | | 188 | 4150176100 | OPAK DÜZ UÇ TRNV 6X100 ELTA | | 193 |
| 450031415 | 2A YLD ANH SB 1415 ELTA | | 188 | 4150176125 | OPAK DÜZ UÇ TRNV 6X125 ELTA | | 193 |
| 450031617 | 2A YLD ANH SB 1617 ELTA | | 188 | 4150176150 | OPAK DÜZ UÇ TRNV 6X150 ELTA | | 193 |
| 450031819 | 2A YLD ANH SB 1819 ELTA | | 188 | 4150177150 | OPAK DÜZ UÇ TRNV 7X150 ELTA | | 193 |
| 450032022 | 2A YLD ANH SB 2022 ELTA | | 188 | 4150178150 | OPAK DÜZ UÇ TRNV 8X150 ELTA | | 193 |
| 450032123 | 2A YLD ANH SB 2123 ELTA | | 188 | 4150178175 | OPAK DÜZ UÇ TRNV 8X175 ELTA | | 193 |
| 450032426 | 2A YLD ANH SB 2426 ELTA | | 188 | 4170180360 | OPAK YLD UÇ TRNV 3X60 ELTA | | 193 |
| 450032528 | 2A YLD ANH SB 2528 ELTA | | 188 | 4170184580 | OPAK YLD UÇ TRNV 4,5X80 ELTA | | 193 |
| 450032732 | 2A YLD ANH SB 2732 ELTA | | 188 | 4170186100 | OPAK YLD UÇ TRNV 6X100 ELTA | | 193 |

| KOD | ÜRÜN | FİYAT | SAYFA |
|------------|--------------------------------|-------|-------|
| 4170188150 | OPAK YLD UÇ TRNV 8X150 ELTA | | 193 |
| 4150008106 | OPAK DÜZ&YLD UÇ TRNV SET6 ELTA | | 193 |
| 4150008107 | OPAK DÜZ&YLD UÇ TRNV SET7 ELTA | | 193 |
| 4908220015 | 6KŞ ALLEN ANH 1,5 ELTA | | 194 |
| 4908220020 | 6KŞ ALLEN ANH 02 ELTA | | 194 |
| 4908220025 | 6KŞ ALLEN ANH 2,5 ELTA | | 194 |
| 4908220030 | 6KŞ ALLEN ANH 03 ELTA | | 194 |
| 4908220035 | 6KŞ ALLEN ANH 3,5 ELTA | | 194 |
| 4908220040 | 6KŞ ALLEN ANH 04 ELTA | | 194 |
| 4908220050 | 6KŞ ALLEN ANH 05 ELTA | | 194 |
| 4908220060 | 6KŞ ALLEN ANH 06 ELTA | | 194 |
| 4908220070 | 6KŞ ALLEN ANH 07 ELTA | | 194 |
| 4908220080 | 6KŞ ALLEN ANH 08 ELTA | | 194 |
| 4908220090 | 6KŞ ALLEN ANH 09 ELTA | | 194 |
| 4908220100 | 6KŞ ALLEN ANH 10 ELTA | | 194 |
| 4908220120 | 6KŞ ALLEN ANH 12 ELTA | | 194 |
| 4908003107 | 6KŞ ALLEN ANH TK7 ELTA | | 194 |
| 4908003109 | 6KŞ ALLEN ANH TK9 ELTA | | 194 |
| 4908003110 | 6KŞ ALLEN ANH TK10 ELTA | | 194 |
| 4922220025 | TTİP ALLEN ANH 2,5 ELTA | | 194 |
| 4922220030 | TTİP ALLEN ANH 03 ELTA | | 194 |
| 4922220040 | TTİP ALLEN ANH 04 ELTA | | 194 |
| 4922220050 | TTİP ALLEN ANH 05 ELTA | | 194 |
| 4922220060 | TTİP ALLEN ANH 06 ELTA | | 194 |
| 4922220070 | TTİP ALLEN ANH 07 ELTA | | 194 |
| 4922220080 | TTİP ALLEN ANH 08 ELTA | | 194 |
| 4922220100 | TTİP ALLEN ANH 10 ELTA | | 194 |
| 4922008108 | TTİP ALLEN ANH TK8 ELTA | | 194 |
| 4915006106 | KST ALLEN ANH 2,5-8 ELTA | | 195 |
| 5011230006 | ISKPL DÜZ 06 ELTA | | 195 |
| 5011230008 | ISKPL DÜZ 08 ELTA | | 195 |
| 5011230010 | ISKPL DÜZ 10 ELTA | | 195 |
| 5011230012 | ISKPL DÜZ 12 ELTA | | 195 |
| 5011230014 | ISKPL DÜZ 14 ELTA | | 195 |
| 5011230016 | ISKPL DÜZ 16 ELTA | | 195 |
| 5011230018 | ISKPL DÜZ 18 ELTA | | 195 |
| 5011230020 | ISKPL DÜZ 20 ELTA | | 195 |
| 5011230022 | ISKPL DÜZ 22 ELTA | | 195 |
| 5011230024 | ISKPL DÜZ 24 ELTA | | 195 |
| 5011230026 | ISKPL DÜZ 26 ELTA | | 195 |
| 5011230030 | ISKPL DÜZ 30 ELTA | | 195 |
| 5884260003 | PLS ŞRT MT3 ELTA | | 195 |
| 5884260005 | PLS ŞRT MT5 ELTA | | 195 |
| 5891260830 | TSTR KOL 300 ELTA | | 195 |
| 6351260400 | LVY OLK 400 ELTA | | 195 |
| 6351260500 | LVY OLK 500 ELTA | | 195 |
| 6351260600 | LVY OLK 600 ELTA | | 195 |
| 6730270550 | ÇİM KSM MKS DÜZ AĞZ 550 ELTA | | 196 |
| 6731270650 | ÇİM KSM MKS EĞRİ AĞZ 650 ELTA | | 196 |
| 6721270205 | BAĞ MKS 205 ELTA | | 196 |
| 6722270220 | BAĞ MKS HAF 220 ELTA | | 196 |







İŞIKKENT FABRİKASI



58.280 M² Açık 24.320 M² Kapalı Alan

TURGUTLU FABRİKASI



40.415 M² Açık 13.120 M² Kapalı Alan

SÜTÇÜLER FABRİKASI



41.225 M² Açık 14.050 M² Kapalı Alan

ALİAĞA FABRİKASI



Aliaga Fabrikası yakında hizmetinizde...

50.000 M² Arsa



İZELTAŞ İZMİR EL ALETLERİ SANAYİ VE TİCARET A.Ş.

Kemalpaşa Cad. No: 303
Işıkent / İzmir / TÜRKİYE

Sipariş Telefon
Phone for orders

DT: +90 232 472 13 92
T: +90 232 472 13 75
F: +90 232 472 13 78

Adana Bölge Müdürlüğü
Adana Office

+90 533 495 53 09

Ankara Bölge Müdürlüğü
Ankara Office

+90 533 603 47 29

İstanbul Bölge Müdürlüğü
İstanbul Office

+90 533 603 41 81
+90 535 461 54 87

www.izeltas.com.tr

DİJİTAL DÜNYA'DA **BİZİ TAKİP EDİN**

izeltas_
 /izeltaselaetleri
 İZELTAŞ
 izeltas A.S.